



PLASSON[®]
Flow Solutions

Catalogue

2023



Catalogue 2023

PLASSON's innovative products revolutionized the way of connecting polyethylene pipes in the 1960's. We started with fittings for agricultural irrigation and later developed solutions for urban water distribution.

Nowadays, water delivery systems in many of the world's great cities owe their excellence to PLASSON's innovative research and development.

PLASSON ensures superior designs and products, the widest range of fittings and adaptors and a genuine commitment to quality, delivery and service.

PLASSON continues to strive for the future environment. By using PLASSON products, you help us to invest in our vision of a world where clean, pure water will be everyone's birthright.

En los años sesenta PLASSON revolucionó la forma de conectar tubos de polietileno. En el principio fueron conectores para uso agrícola a partir de los cuales se desarrollaron, más tarde, productos para distribución de agua en sistemas municipales.

Hoy en día, algunas de las más grandes ciudades del mundo, deben la excelencia de sus sistemas de suministro de aguas a la investigación y desarrollo de PLASSON.

PLASSON no ha ahorrado esfuerzos para desarrollar, mediante excelente diseño, empleando los mejores materiales y con un total compromiso de calidad y servicio, la más amplia línea de conectores y adaptadores.

Nuestro compromiso con el medio ambiente es permanente. Comprando productos PLASSON, usted está ayudándonos a seguir invirtiendo en nuestra visión de un mundo donde agua limpia y pura es un derecho natural de todos.

Content

Mechanical Fittings	9-89
ElectroFusion Fittings	97-159
ElectroFusion Tooling	165-188
Series 1 Fittings	193-234
Silver Line Fittings	241-255





The logo consists of a red square containing a white icon of a pipe with a valve, followed by the word "PLASSON" in white, uppercase, sans-serif font.

PLASSON

MECHANICAL FITTINGS

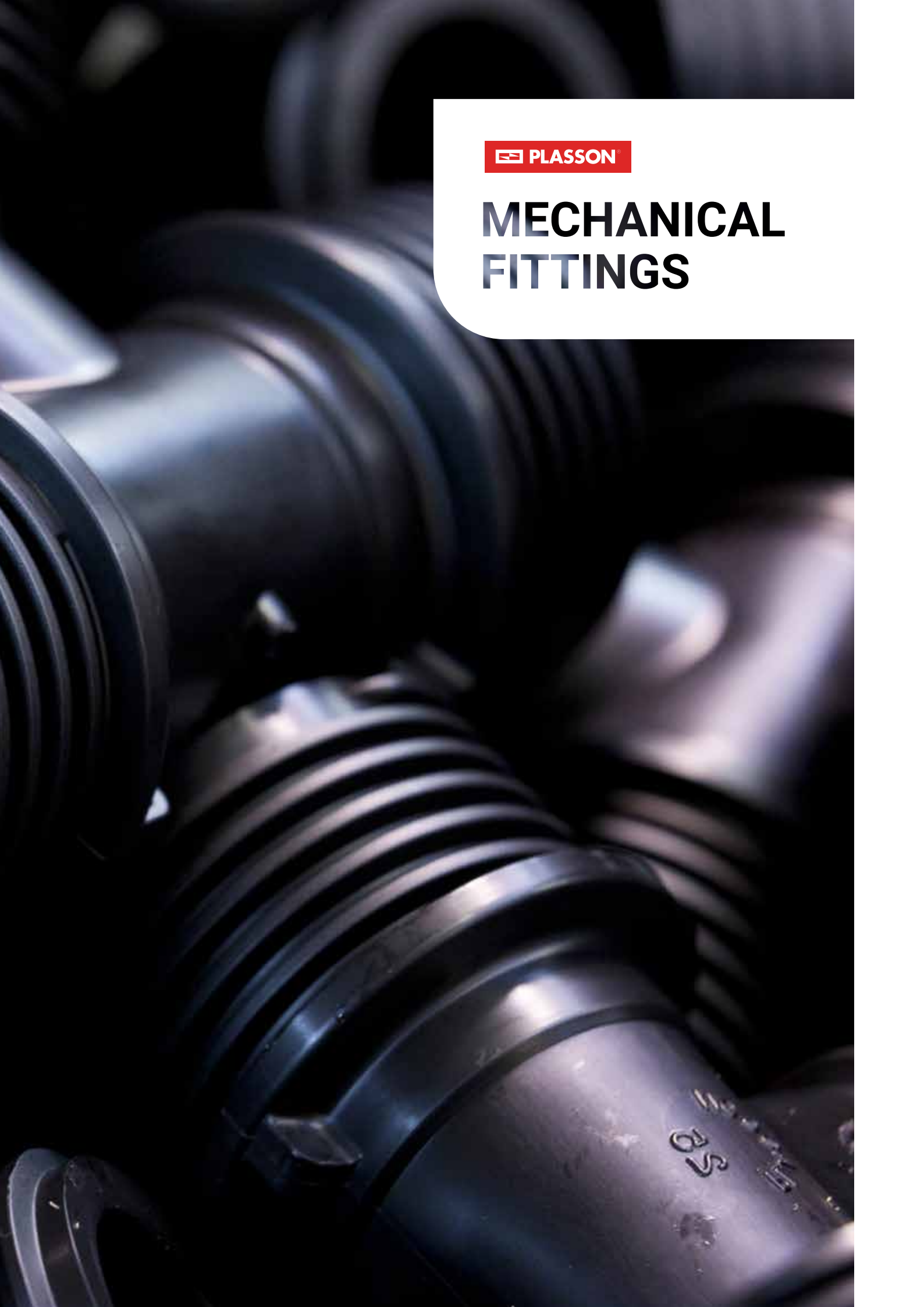

Content

MECHANICAL FITTINGS

Compression Fittings for PE pipe	17-38
Conversion & Adaptor Sets from PE to Copper / UPVC / PP / Lead / Galvanised Pipe	39-44
Pipe Conversion Chart	45
Accessories for Compression Fittings	46-51
Fittings for 160mm PE Pipe	51-54
Saddles	55-60
BSP Threaded Fittings	61-67
Valves	68-75
Quarter Turn Valves	76
Technical Specifications	77-81
Installation Instructions for Compression Fittings	82-84
Installation Instructions for Pipe Adaptors Conversion Sets	85-87
Installation Instructions for Plass4 and Copper Pipe Adaptor (Universal Adaptor)	88-89

ACCESORIOS MECÁNICOS

Accesorios Mecánicos para tuberías de PEAD	17-38
Juegos de conversión y adaptadores de PE a Cobre / PVC rígido/ PP / Plomo / Tubos galvanizados	39-44
Gráfico de conversiones para tuberías	45
Recambios y Accesorios	46-51
Accesorios para tuberías de PE 160mm	51-54
Collarines	55-60
Accesorios roscados (BSP)	61-67
Válvulas	68-75
Válvulas Quarter Turn	76
Detalles técnicos	77-81
Instrucciones de montaje (para accesorios de compresión)	82-84
Instrucciones de montaje (para adaptadores de tubos) Juegos de conversión	85-87
Instrucciones de montaje de Plass4 & tubo de cobre y adaptador Universal	88-89

Compression Fittings

07010

Page 17 | Coupling
Enlace recto



07610

Page 17 | Repair Coupling
Enlace recto de reparación



07110

Page 18 | Reducing Coupling
Enlace Recto Reductor



07020

Page 19 | Male Adaptor
Enlace mixto rosca macho



07720

Page 20 | Male Integral Brass Thread
Enlace mixto rosca macho de latón



07030

Page 21 | Female Adaptor
Enlace mixto rosca hembra



0703G

Page 21 | Female Adaptor G
Enlace mixto rosca hembra G



07320

Page 22 | Shouldered Adaptor
Adaptador minero



07120

Page 22 | End Plug
Tapón final



07050

Page 23 | 90° Elbow
Codo de 90°



07510

Page 23 | 90° Reducing Elbow
Codo de 90° reductor



07850

Page 24 | 90° Elbow with Threaded Male Offtake
Codo de 90° compresión rosca macho



07770

Page 25 | 90° Elbow with Male Integral Brass
Codo de 90° con macho integral de latón



07150

Page 26 | 90° Elbow with Threaded Female Offtake
Codo de 90° compresión rosca hembra



07060

Page 27 | 45° Elbow
Codo de 45°



07450

Page 27 | 45° Elbow with Threaded Male Offtake
Codo de 45° compresión rosca macho



07350

Page 28 | 90° Elbow Adaptor
Codo espiga



07750

Page 28 | Wall Plate Elbow
Codo de aplicación mural



07040

Page 29

90° Tee
Te de 90°



0704P

Page 29

90° Slip Tee
Te de 90° de reparación



07740

Page 30

90° Enlarging Tee
Te de 90° alargado



07340

Page 30

90° Reducing Tee
Te de 90° reductor



07840

Page 31

90° Tee with Threaded
Male Offtake
Te de 90° compresión
rosca macho



0714S

Page 31

90° Reducing Tee with
Threaded Female Offtake
Te de 90° reducción
compresión rosca hembra



07140 / 0714P

Page 32

90° Tee with Threaded
Female Offtake/Slip Tee
Te de 90° compresión rosca
hembra/Te de reparación



07810

Page 33

Coupling with Riser
Enlace recto con derivación
rosca macho



07640

Page 33

45° Tee
Te de 45°



07220

Page 34

Compression Flange
Adaptor (with metal flange)
Adaptador compresión-
brida (con brida de metal)



072306

Page 34

Flange Adaptor (with metal
flange)
Adaptador espiga-brida (con
brida de metal)



07006

Page 35

Metal Flange
Brida de metal



07250

Page 36

Threaded Adaptor
Adaptador compresión
rosca macho



07270

Page 37

Brass Threaded Adaptor
Adaptador rosca de latón



07017

Page 37

Plass4 Coupling (Universal)
Plass4 Enlace universal



07057

Page 38

Plass4 (Universal) Elbow
Codo universal - Plass4



07550

Page 38

Y-fitting with Threaded
Male Offtake
Y compresión rosca macho



07540

Page 38

Cross with Threaded
Female Offtake
Cruz compresión rosca hembra



Conversion & Adaptor Sets

071209

Page 39

Plug Adaptor
Tapón ciego



07950

Page 39

Pipe Liner for
PE SDR 11 Pipe
Refuerzo de tubos



07896

Page 40

Adaptor for Copper and
Imperial UPVC
Adaptador universal para
tubos de cobre y UPVC imperial



07930

Page 40

Reducing Set
Juego reductor



07940

Page 41

Modular Adaptor
Adaptador modular



0701C6

Page 41

Copper Pipe Adaptor
Adaptador tudo de cobre



07970

Page 42

Grip Ring for UPVC and PP
Pipe
Casquillo de apriete para
tubos de UPVC y PP



074380

Page 42

Conversion Set for Copper
Pipe
Juego adaptador para tubos
de cobre



0701QQ

Page 43

Coupling for PVC Pipe
Enlace recto para tubo de
PVC



077802

Page 43

Conversion Set for Lead
Pipe
Juego adaptador para tubos
de plomo



078908

Page 44

Converter Rubber Adaptor for
Galvanised Pipe
Convertor Adaptador de goma
para tubos de acero galvanizado



078907

Page 44

Conversion Set Adaptor for
Galvanised Pipe
Juego convertor de compresion
para tubos de acero galvanizado



Accessories for Compression Fittings

07004

Page 46

Nut
Racor



07002

Page 46-48

O - Ring / Seal
Junta tórica / sello



07003

Page 48-49

Split Ring
Casquillo de apriete



07003Q

Page 49

Split Ring for PVC Pipe
Garra para tubo de PVC



07005

Page 50

Insert
Inserto de PP



18960

Page 50

Chamfer Tool for PE Pipes
Herramienta para biselar



07960

Page 50

Chamfer Tool for PE Pipes
Herramienta para biselar



07990

Page 51

PLASSON Wrench
Llave PLASSON



072306

Page 53

Flange Adaptor (with metal flange)
Adaptador brida-espiga (con brida de metal)



073206

Page 54

Shouldered Adaptor
Adaptador minero



070060160

Page 54

Half Metal Flange
Brida de metal



Fittings for 160mm Pipes

070106

Page 51

Coupling
Enlace recto



076106

Page 51

Repair Coupling
Enlace recto de reparación



070406

Page 52

90° Tee
Te de 90°



070506

Page 52

90° Elbow
Codo de 90°



072206

Page 53

Compression Flange Adaptor (with metal flange)
Adaptador compresión-brida (con brida de metal)



Threaded Outlet Saddles

16076

Page 55

Saddle Single Outlet with Reinforcing Ring Options
Collarin simple con anillo de refuerzo



16176

Page 56

Saddle Double Outlet with Reinforcing Ring Options
Collarin doble con anillo de refuerzo



16005

Page 57

Plated Nut & Bolt for Saddles
Tornillo y tuerca de acero niquelado para collarin



Tapping Saddles & Valves

18680

Page 57

Mechanical Tapping Valve
Valvula Mecanica con salida rotatoria Tapper[®]



16300

Page 59

PLASSADDLE Threaded



16310

Page 60

PLASSADDLE Threaded



1631R

Page 60

PLASSADDLE Tapper Male



BSP Threaded Fittings

050107

Page 61

Threaded Socket
Manguito rosca hembra x hembra



050117

Page 61

Threaded Socket with Reinforced Ring
Manguito reductor rosca hembra-hembra con anillo de refuerzo



050207

Page 62

Threaded Reducing Bushing
Manguito reductor hembra x macho



050407

Page 63

90° Threaded Tee
Te de 90° rosca hembra



050507

Page 63

90° Threaded Elbow
Codo de 90° rosca hembra



050517

Page 64

Threaded Elbow with Reinforced Ring
Codo 90° de rosca hembra con anillo de refuerzo



051507

Page 64

90° Threaded Elbow Male x Female
Codo roscado-macho x hembra



051607

Page 65

Threaded Riser
Espiga roscada



051707

Page 65

Threaded Plug
Tapón rosca macho



050605

Page 66

Threaded Reducing Nipple
Machón doble reductor



050607

Page 66

Threaded Nipple
Machón doble



050707

Page 67

Threaded Cap
Tapón rosca hembra



051107

Page 67

Threaded Reducing Socket
Manguito reductor rosca hembra - hembra



Valves

03703

Page 68

Ball Valve
Válvula esférica



0370302

Page 68

PA Ball Valve Female x Male



03405

Page 69

Threaded Stoptap
(Seal NBR)
Válvula de línea rosca
hembra (juntas NBR)



03406

Page 69

Compression Stoptap
(Seal NBR)
Válvula de línea compresión
(juntas NBR)



03048/03948

Page 69

Angle Seat Valve (Seal NBR)
Threaded x Compression
Válvula de asiento angular -
compresión - rosca macho
- juntas NBR



03047

Page 70

Angle Seat Valve (seal NBR),
Threaded Inlet & Outlet
Válvula de asiento angular
(sello NBR), roscas macho



03049

Page 70

Angle Seat Valve (seal FPM),
Threaded Inlet & Outlet
Válvula de asiento angular
(sello FPM), roscas macho



03046

Page 71

Angle Seat Valve (Seal NBR)
Compression Inlet & Outlet
Válvula de asiento angular,
(sello NBR) compresión



03067

Page 71

Check Valve (Seal EPDM)
Threaded Inlet & Outlet
Válvula antirretorno, (sello
EPDM) roscas macho



03801

Page 71

Fix Ratio Pressure
Reducing Valve



0220

Page 72

Universal Pressure
Regulator UPR 550



03039

Page 72

Quick Coupling Valve
(Seal NBR)
Válvula de acople rápido
(juntas NBR)



03139

Page 72

Key for Quick Coupling
Valve 3039
Conexión de acople rápido



03226 / 03227

Page 73

Check Valve Insert
Válvula de antirretorno



3589

Page 73

BSPT Record for Water
Meter
Tubo y tuerca BSPT



03510T

Page 74

Water Meter Seat



03510

Page 74

Water Meter Manifold
Soporte para control de flujo
de agua



036010

Page 74

PP Ball Valve - Compression
X Compression



036020

Page 75

PP Ball Valve -
Compression X Male
Threaded



036030

Page 75

PP Ball Valve - Compression
X Female Threaded



Quarter Turn Valves

03010

Page 76

Quarter Turn Valve Male
Threaded x Compression
Rosca Macho/Compresión



03012

Page 76

Quarter Turn Valve Male
Threaded x Female Threaded
Rosca Macho-/Rosca Hembra



03017

Page 76

Quarter Turn Valve
Compression x Compression
Compresión



Coupling

07010

Enlace recto

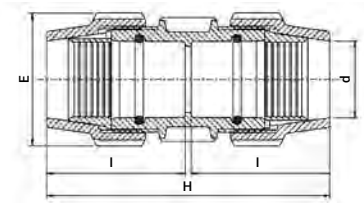

Product Code	Size d x d	E	H	I	UB	UC	W
070106016	16 x 16	39	105	50	10	400	52
0701060200A	20 x 20	48	122	59	10	200	93
0701060250A	25 x 25	54	126	61	10	180	116
0701060320A	32 x 32	64	145	71	5	100	181
0701060400A	40 x 40	82	177	87	—	75	310
0701060500A	50 x 50	96	201	98	—	45	457
0701060630A	63 x 63	113	230	113	—	30	741
0701060750A	75 x 75	134	278	138	—	16	1183
0701060900A	90 x 90	154	335	165	—	10	1898
0701061100A	110 x 110	181	393	194	—	5	3129
0701061250A	125 x 125	212	460	225	—	3	5347

Repair Coupling

07610

Enlace recto de reparación

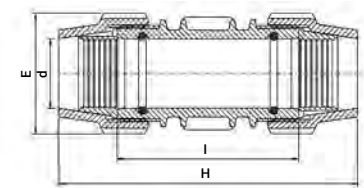

Product Code	Size d x d	E	H	I	UB	UC	W
0761060200A	20 x 20	48	122	78	10	240	141
0761060250A	25 x 25	54	136	90	10	150	119
0761060320A	32 x 32	64	174	120	5	80	202
0761060400A	40 x 40	82	215	148	—	55	360
0761060500A	50 x 50	96	244	158	—	30	536
0761060630A	63 x 63	113	270	170	—	24	836
0761060750A	75 x 75	134	278	139	—	16	1178
0761060900A	90 x 90	154	335	168	—	10	1852
0761061100A	110 x 110	181	393	197	—	5	3098
0761061250A	125 x 125	212	460	265	—	3	5318

Reducing Coupling

07110

Enlace Recto Reductor

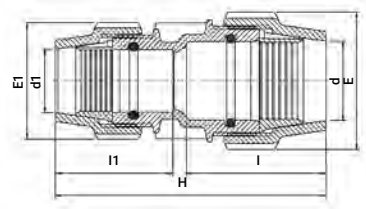

Product Code	Size d x d1	E	E1	H	I	I1	UB	UC	W
0711060200160A	20 x 16	48	39	111	57	50	10	300	74
0711060250160A	25 x 16	54	39	113	58	50	10	220	88
0711060250200A	25 x 20	54	48	119	58	57	10	200	100
0711060320200A	32 x 20	64	48	140	67	57	5	150	142
0711060320250A	32 x 25	64	54	133	67	58	5	120	143
0711060400250A	40 x 25	82	54	156	84	58	—	90	219
0711060400320A	40 x 32	82	64	156	84	67	—	90	245
0711060500250A	50 x 25	96	54	176	93	58	—	70	305
0711060500320A	50 x 32	96	64	175	98	62	—	70	332
0711060500400A	50 x 40	96	82	184	93	84	—	60	381
0711060630250A	63 x 25	113	54	193	110	58	—	50	461
0711060630320A	63 x 32	113	64	197	110	62	—	45	486
0711060630400A	63 x 40	113	82	208	110	82	—	40	546
0711060630500A	63 x 50	113	96	214	110	93	—	36	574
0711060750500A	75 x 50	134	96	245	132	98	—	22	846
0711060750630A	75 x 63	134	113	252	132	112	—	20	960
0711060900630A	90 x 63	154	113	292	170	115	—	14	1415
0711060900750A	90 x 75	154	134	330	170	134	—	12	1609
0711061100900A	110 x 90	181	154	378	194	162	—	6	2643

Male Adaptor

07020

Enlace mixto rosca macho

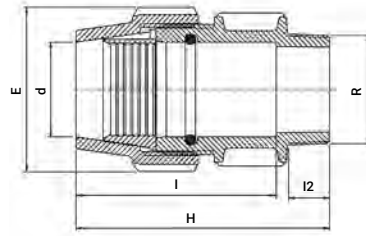

Product Code	Size d x R	E	H	I	I2	UB	UC	W
0702060160030A	16 x 3/8"	39	76	59	13	10	600	33
0702060160050A	16 x 1/2"	39	79	59	16	10	500	34
0702060160070A	16 x 3/4"	39	79	59	17	10	500	35
0702060200050A	20 x 1/2"	48	92	71	17	10	350	58
0702060200070A	20 x 3/4"	48	92	71	18	10	350	59
0702060200100A	20 x 1"	48	86	52	20	10	350	60
0702060250050A	25 x 1/2"	54	94	72	17	10	250	68
0702060250070A	25 x 3/4"	54	95	72	18	10	250	73
0702060250100A	25 x 1"	54	97	72	20	10	250	79
0702060320070A	32 x 3/4"	64	106	83	18	5	150	113
0702060320100A	32 x 1"	64	107	83	20	5	150	122
0702060320130A	32 x 1 1/4"	64	110	83	22	5	150	114
0702060320150A	32 x 1 1/2"	64	110	83	22	5	140	127
0702060400100A	40 x 1"	82	118	91	20	—	110	184
0702060400130A	40 x 1 1/4"	82	117	90	22	—	110	185
0702060400150A	40 x 1 1/2"	82	117	90	22	—	100	185
0702060400200A	40 x 2"	82	123	91	26	—	100	208
0702060500100A	50 x 1"	96	133	106	20	—	70	266
0702060500130A	50 x 1 1/4"	96	136	106	22	—	70	266
0702060500150A	50 x 1 1/2"	96	136	109	22	—	70	277
0702060500200A	50 x 2"	96	140	109	26	—	65	284
0702060630130A	63 x 1 1/4"	113	154	123	22	—	48	443
0702060630150A	63 x 1 1/2"	113	154	123	22	—	48	451
0702060630200A	63 x 2"	113	167	123	26	—	48	461
0702060630250A	63 x 2 1/2"	113	160	123	29	—	45	459
0702060750200A	75 x 2"	132	188	150	26	—	28	710
0702060750250A	75 x 2 1/2"	132	191	150	29	—	28	712
0702060750300A	75 x 3"	132	195	150	33	—	25	718
0702060900200A	90 x 2"	152	227	170	26	—	16	1123
0702060900250A	90 x 2 1/2"	152	229	170	29	—	16	1142
0702060900300A	90 x 3"	152	232	170	33	—	16	1133
0702060900400A	90 x 4"	152	239	170	40	—	16	1226
0702061100200A	110 x 2"	181	261	213	26	—	10	1845
0702061100300A	110 x 3"	181	256	213	34	—	10	1850
0702061100400A	110 x 4"	181	265	213	42	—	8	1872

Male Integral Brass Thread

07720

Enlace mixto rosca macho de laton

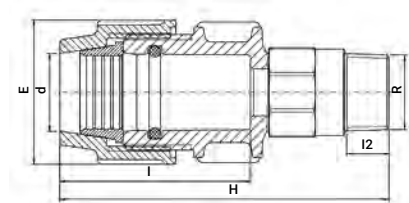

Product Code	Size d x R	E	H	I	I2	UB	UC	W
0772060320070A	32 x 3/4"	64	139	83	18	1	100	240
0772060320100A	32 x 1"	64	141	83	20	1	100	276
0772060320130A	32 x 1 1/4"	64	142	83	22	1	75	300
0772060320150A	32 x 1 1/2"	64	142	83	22	1	100	330
0772060400070A	40 x 3/4"	82	149	91	18	1	65	413
0772060400100A	40 x 1"	82	151	91	20	1	65	413
0772060400130A	40 x 1 1/4"	82	154	91	22	1	65	428
0772060400150A	40 x 1 1/2"	82	153	91	22	1	55	428
0772060500100A	50 x 1"	96	169	106	20	1	45	539
0772060500130A	50 x 1 1/4"	96	172	106	22	1	45	563
0772060500150A	50 x 1 1/2"	96	172	106	22	1	45	586
0772060630130A	63 x 1 1/4"	113	190	123	22	1	30	842
0772060630150A	63 x 1 1/2"	113	190	123	22	1	30	874
0772060630200A	63 x 2"	113	194	123	26	1	30	855

Female Adaptor

07030

Enlace mixto rosca hembra

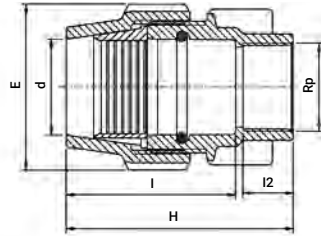

Product Code	Size d x Rp	E	H	I	I2	UB	UC	W
0703060160050A	16 x 1/2"	39	73	52	19	10	500	36
0703060160070A	16 x 3/4"	39	75	53	19	10	500	36
0703060200050A	20 x 1/2"	48	82	60	19	10	350	60
0703060200070A	20 x 3/4"	48	82	60	19	10	350	58
0703060200100A	20 x 1"	48	92	57	21	10	300	68
0703060250070A	25 x 3/4"	54	88	63	21	10	250	83
0703060250100A	25 x 1"	54	88	63	21	10	250	78
0703060320070A	32 x 3/4"	64	94	73	19	5	150	107
0703060320100A	32 x 1"	64	94	69	21	5	150	115
0703060320130A	32 x 1 1/4"	64	96	67	25	5	140	140
0703060400100A	40 x 1"	82	112	84	21	—	110	178
0703060400130A	40 x 1 1/4"	82	114	84	25	—	110	202
0703060400150A	40 x 1 1/2"	82	114	84	25	—	100	225
0703060500130A	50 x 1 1/4"	96	123	93	25	—	75	276
0703060500150A	50 x 1 1/2"	96	123	93	25	—	70	277
0703060500200A	50 x 2"	96	128	93	30	—	70	294
0703060630130A	63 x 1 1/4"	113	139	110	25	—	48	417
0703060630150A	63 x 1 1/2"	113	139	110	25	—	48	438
0703060630200A	63 x 2"	113	148	110	30	—	48	443
0703060750200A	75 x 2"	132	175	132	30	—	28	662
0703060750250A	75 x 2 1/2"	132	170	132	33	—	28	683
0703060900200A	90 x 2"	154	213	183	30	—	16	1138
0703060900300A	90 x 3"	154	223	183	40	—	16	1204
0703060900400A	90 x 4"	154	243	183	52	—	12	1444
0703061100300A	110 x 3"	181	261	213	40	—	8	1919
0703061100400A	110 x 4"	181	271	213	50	—	8	2048

Female Adaptor G

0703G0*

Enlace mixto rosca hembra G

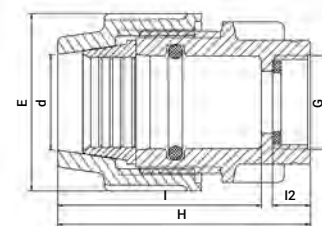

Product Code	Size d x G	E	H	I	I2	UB	UC	W
0703G60250070A	25 x 3/4"	54	88	63	12	10	250	83
0703G60250100A	25 x 1"	54	88	63	14	10	250	78
0703G60320100A	32 x 1"	64	89	72	14	5	150	115

* For connecting parallel male thread | * Para conectar rosca macho paralelo

Shouldered Adaptor

07320

Adaptador minero

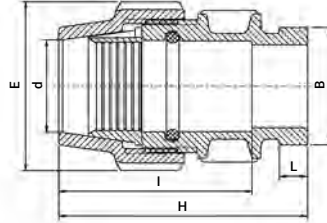

Product Code	Size d x DN (inch)	E	I	L	H	B	UB	UC	W
0732060500200A	50 x 50 (2")	96	109	16	138	67	—	65	293
0732060630200A	63 x 50 (2")	113	123	16	156	67	—	45	437
0732060900400A	90 x 100 (4")	154	170	16	231	123	—	16	1213
0732061100400A	110 x 100 (4")	181	213	16	255	123	—	8	1874

End Plug

07120

Tapón final

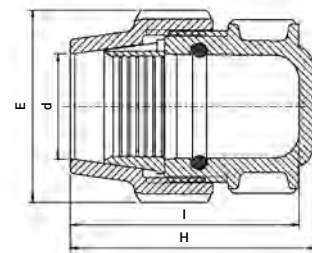

Product Code	Size d	E	I	H	UB	UC	W
0712060200A	20	48	74	79	10	350	57
0712060250A	25	54	77	82	10	250	72
0712060320A	32	64	87	92	5	180	108
0712060400A	40	82	97	102	—	110	186
0712060500A	50	96	114	121	—	75	270
0712060630A	63	113	122	145	—	45	448
0712060750A	75	134	155	172	—	28	710
0712060900A	90	154	170	212	—	16	1139
0712061100A	110	181	213	231	—	10	1835

90° Elbow

07050

Codo de 90°

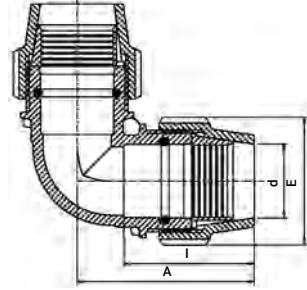

Product Code	Size d x d	E	I	A	UB	UC	W
0705060160A	16 x 16	39	50	63	10	350	57
0705060200A	20 x 20	48	56	73	10	200	95
0705060250A	25 x 25	54	58	79	10	150	122
0705060320A	32 x 32	64	67	93	5	100	187
0705060400A	40 x 40	82	82	108	—	60	341
0705060500A	50 x 50	96	93	127	—	35	497
0705060630A	63 x 63	113	110	151	—	24	838
0705060750A	75 x 75	134	132	178	—	12	1304
0705060900A	90 x 90	154	162	217	—	8	2168
0705061100A	110 x 110	181	194	292	—	4	3810

90° Reducing Elbow

07510

Codo de 90° reductor

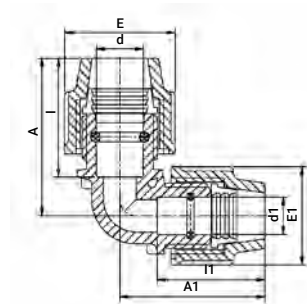

Product Code	Size d x D1	E	E1	I	I1	A	A1	UB	UC	W
0751060250200A	25 x 20	54	48	58	57	90	75	10	180	114

90° Elbow with Threaded Male Offtake

07850

Codo de 90° compresión rosca macho

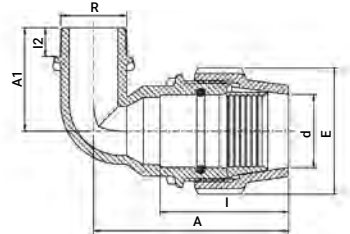

Product Code	Size d x R	E	I	I2	A	A1	UB	UC	W
0785060200050A	20 x 1/2"	48	57	17	74	41	10	350	55
0785060200070A	20 x 3/4"	48	57	18	76	43	10	300	64
0785060250050A	25 x 1/2"	54	58	17	85	47	10	240	70
0785060250070A	25 x 3/4"	54	58	18	90	48	10	250	79
0785060250100A	25 x 1"	54	58	20	90	54	10	240	84
0785060320070A	32 x 3/4"	64	67	18	104	55	5	140	116
0785060320100A	32 x 1"	64	67	20	104	55	5	140	128
0785060320130A	32 x 1 1/4"	64	67	22	104	58	5	140	135
0785060400100A	40 x 1"	82	84	20	124	60	—	90	196
0785060400130A	40 x 1 1/4"	82	84	22	124	66	—	90	205
0785060400150A	40 x 1 1/2"	82	84	22	124	66	—	80	220
0785060500100A	50 x 1"	96	93	20	140	71	—	55	294
0785060500130A	50 x 1 1/4"	96	93	22	144	74	—	55	335
0785060500150A	50 x 1 1/2"	96	93	22	144	74	—	55	321
0785060500200A	50 x 2"	96	93	26	144	76	—	55	373
0785060630130A	63 x 1 1/4"	113	110	22	168	76	—	35	451
0785060630150A	63 x 1 1/2"	113	110	22	168	76	—	35	468
0785060630200A	63 x 2"	113	110	26	170	92	—	35	518
0785060750250A	75 x 2 1/2"	134	132	30	202	105	—	18	872
0785060750300A	75 x 3"	134	132	33	202	110	—	18	892
0785060900300A	90 x 3"	154	165	35	233	110	—	12	1300
0785061100400A	110 x 4"	181	194	42	274	140	—	6	2258

90° Elbow with Male Integral Brass

07770

Code de 90° con macho integral de latón

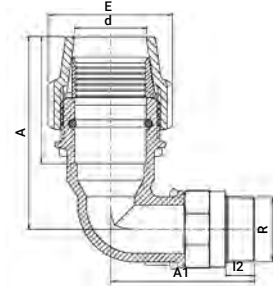

Product Code	Size d x R	E	I	I2	A	A1	UB	UC	W
0777060320070A	32 x 3/4"	64	67	18	104	79	1	75	270
0777060320100A	32 x 1"	64	67	20	104	81	1	70	286
0777060320130A	32 x 1 1/4"	64	67	22	104	82	1	70	343
0777060320150A	32 x 1 1/2"	64	67	22	104	82	1	70	360
0777060400070A	40 x 3/4"	82	84	18	124	86	1	55	435
0777060400100A	40 x 1"	82	84	20	124	88	1	55	435
0777060400130A	40 x 1 1/4"	82	84	22	124	90	1	55	450
0777060400150A	40 x 1 1/2"	82	84	22	124	89	1	55	460
0777060500100A	50 x 1"	96	93	20	144	94	1	40	592
0777060500130A	50 x 1 1/4"	96	93	22	144	97	1	40	613
0777060500150A	50 x 1 1/2"	96	93	22	144	97	1	40	613
0777060630130A	63 x 1 1/4"	113	110	22	168	126	1	27	895
0777060630150A	63 x 1 1/2"	113	110	22	168	126	1	27	955
0777060630200A	63 x 2"	113	110	26	170	129	1	27	987

90° Elbow with Threaded Female Offtake

07150

Codo de 90° compresión rosca hembra

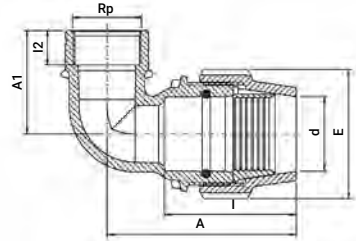

Product Code	Size d x Rp	E	I	I2	A	A1	UB	UC	W
0715060160050A	16 x 1/2"	39	50	19	66	39	10	500	38
0715060200050A	20 x 1/2"	48	54	19	78	40	10	350	61
0715060200070A	20 x 3/4"	48	57	19	78	44	10	300	71
0715060250050A	25 x 1/2"	54	58	18	81	46	10	250	86
0715060250070A	25 x 3/4"	54	58	19	81	46	10	250	81
0715060250100A	25 x 1"	54	58	21	83	50	10	220	90
0715060320070A	32 x 3/4"	64	67	18	95	54	5	150	143
0715060320100A	32 x 1"	64	67	21	95	54	5	150	136
0715060320130A	32 x 1 1/4"	64	67	25	99	60	5	120	167
0715060400100A	40 x 1"	82	84	21	119	52	—	100	201
0715060400130A	40 x 1 1/4"	82	84	25	119	62	—	90	246
0715060400150A	40 x 1 1/2"	82	84	25	119	62	—	80	261
0715060400200A	40 x 2"	82	84	30	119	75	—	65	293
0715060500100A	50 x 1"	96	93	21	133	57	—	70	281
0715060500130A	50 x 1 1/4"	96	93	25	133	67	—	60	313
0715060500150A	50 x 1 1/2"	96	93	25	135	66	—	60	344
0715060500200A	50 x 2"	96	93	30	138	85	—	45	387
0715060630130A	63 x 1 1/4"	113	110	25	162	65	—	35	488
0715060630150A	63 x 1 1/2"	113	110	25	162	69	—	35	504
0715060630200A	63 x 2"	113	110	30	160	90	—	35	559
0715060750200A	75 x 2"	134	132	30	188	100	—	24	810
0715060750250A	75 x 2 1/2"	134	132	36	191	105	—	20	920
0715060750300A	75 x 3"	134	132	36	191	105	—	20	956

45° Elbow

07060

Codo de 45°

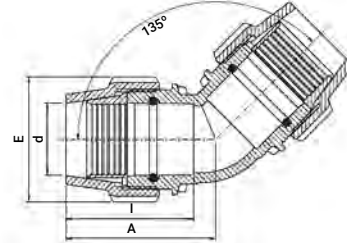

Product Code	Size d x d	E	I	A	UB	UC	W
0706060320A	32 x 32	64	67	92	5	100	189
0706060400A	40 x 40	82	84	99	—	60	330
0706060500A	50 x 50	96	93	110	—	40	476
0706060630A	63 x 63	113	110	130	—	24	772
0706060750A	75 x 75	134	132	153	—	12	1207
0706060900A	90 x 90	154	165	195	—	8	2057
0706061100A	110 x 110	181	194	235	—	5	3418

45° Elbow with Threaded Male Offtake

07450

Codo de 45° compresión rosca macho

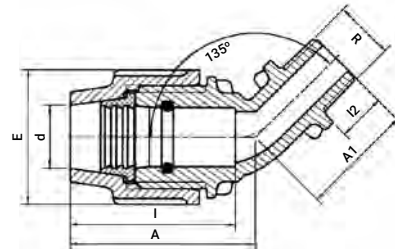

Product Code	Size d x R	E	I	I2	A	A1	UB	UC	W
0745060200050A	20 x 1/2"	48	57	17	64	40	10	350	54
0745060200070A	20 x 3/4"	48	57	18	64	41	10	350	55

90° Elbow Adaptor

07350

Codo espiga

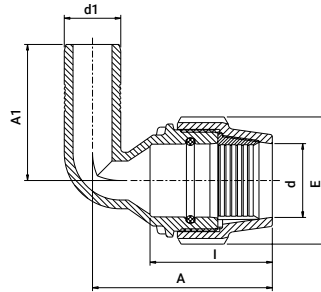

Product Code	Size d x d1	E	I	A	A1	UB	UC	W
0735060400400A	40 x 40	82	84	118	106	—	80	314
0735060400500A	40 x 50	82	84	118	120	—	70	275
0735060500400A	50 x 40	96	93	136	106	—	60	308
0735060500500A	50 x 50	96	93	136	120	—	55	356
0735060630400A	63 x 40	113	110	161	106	—	40	450
0735060630500A	63 x 50	113	110	161	120	—	35	511

Wall Plate Elbow

07750

Codo de aplicación mural

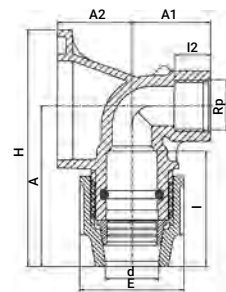

Product Code	Size d x Rp	E	I	I2	A	A1	A2	H	UB	UC	W
0775060160050A	16 x 1/2"	39	50	18	76	40	38	110	1	150	98
0775060200050A	20 x 1/2"	48	57	18	78	40	38	110	1	150	92
0775060250070A	25 x 3/4"	54	58	19	81	40	38	120	1	100	115

90° Tee

07040

Te de 90°

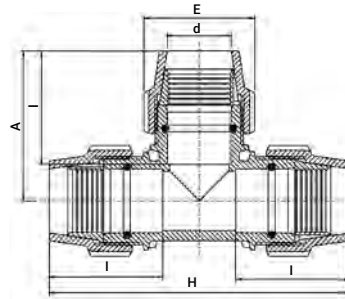

Product Code	Size d x d x d	E	H	I	A	UB	UC	W
0704060160A	16 x 16 x 16	39	126	50	63	10	220	83
0704060200A	20 x 20 x 20	48	145	56	73	10	120	141
0704060250A	25 x 25 x 25	54	156	58	78	5	100	173
0704060320A	32 x 32 x 32	64	185	67	93	5	60	285
0704060400A	40 x 40 x 40	82	221	86	111	—	40	501
0704060500A	50 x 50 x 50	96	252	95	126	—	25	741
0704060630A	63 x 63 x 63	113	294	110	146	—	16	1215
0704060750A	75 x 75 x 75	132	353	132	177	—	8	1890
0704060900A	90 x 90 x 90	154	439	165	220	—	5	3161
0704061100A	110 x 110 x 110	181	583	194	292	—	2	5584

90° SlipTee

0704P0

Te de 90° de reparación

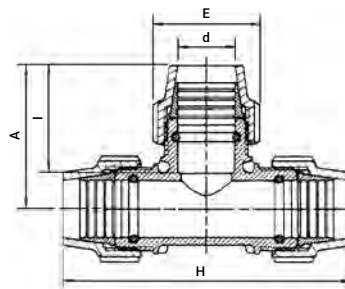

Product Code	Size d x d x d	E	H	I	A	UB	UC	W
0704P60200A	20 x 20 x 20	48	145	56	73	10	120	133
0704P60250A	25 x 25 x 25	54	156	58	78	5	100	173
0704P60320A	32 x 32 x 32	64	185	67	93	5	60	280
0704P60400A	40 x 40 x 40	82	221	86	111	—	40	489
0704P60500A	50 x 50 x 50	96	252	95	126	—	25	720
0704P60630A	63 x 63 x 63	113	294	110	146	—	16	1107

90° Enlarging Tee

07740

Te de alargado

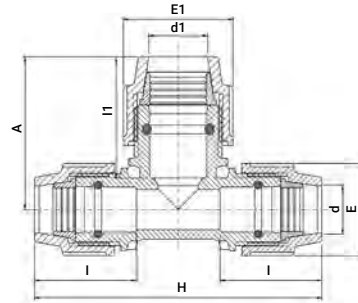

Product Code	Size d x d1 x d	E	E1	H	I	I1	A	UB	UC	W
0774060320250A	25 x 32 x 25	54	64	156	58	69	87	5	80	219

90° Reducing Tee

07340

Te de 90° reductor

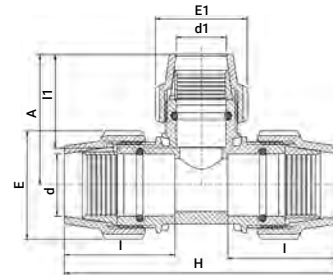

Product Code	Size d x d1 x d	E	E1	H	I	I1	A	UB	UC	W
0734060200160A	20 x 16 x 20	48	39	137	57	50	70	10	150	125
0734060250200A	25 x 20 x 25	54	48	150	58	57	74	5	100	166
0734060320250A	32 x 25 x 32	64	54	173	67	58	63	5	70	256
0734060400250A	40 x 25 x 40	82	54	205	84	58	84	—	45	412
0734060400320A	40 x 32 x 40	82	64	207	82	67	97	—	40	428
0734060500250A	50 x 25 x 50	96	54	228	93	76	105	—	30	550
0734060500320A	50 x 32 x 50	96	64	230	93	67	117	—	30	590
0734060500400A	50 x 40 x 50	96	82	236	93	82	114	—	30	647
0734060630320A	63 x 32 x 63	113	64	268	113	62	118	—	20	892
0734060630400A	63 x 40 x 63	113	82	268	113	84	139	—	20	962
0734060630500A	63 x 50 x 63	113	96	275	110	93	132	—	18	1021
0734060750630A	75 x 63 x 75	132	113	353	132	109	153	—	10	1667

90° Tee with Threaded Male Offtake

07840

Te de 90° compresión rosca macho

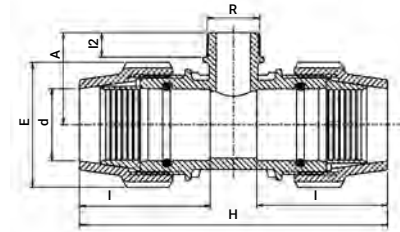

Product Code	Size d x R x d	E	H	I	I2	A	UB	UC	W
0784060200050A	20 x 1/2" x 20	48	138	56	17	46	10	180	105
0784060200070A	20 x 3/4" x 20	48	144	56	18	46	10	180	108
0784060250050A	25 x 1/2" x 25	54	146	58	17	48	5	140	134
0784060250070A	25 x 3/4" x 25	54	146	58	18	50	5	140	137
0784060320100A	32 x 1" x 32	64	170	67	20	58	5	80	218
0784060400130A	40 x 1 1/4" x 40	82	205	84	22	71	—	50	373
0784060400150A	40 x 1 1/2" x 40	82	205	84	22	71	—	50	376
0784060500130A	50 x 1 1/4" x 50	96	230	93	22	77	—	36	511
0784060500150A	50 x 1 1/2" x 50	96	230	93	22	77	—	36	523
0784060500200A	50 x 2" x 50	96	230	93	26	82	—	36	523
0784060630130A	63 x 1 1/4" x 63	113	268	113	22	79	—	20	821
0784060630150A	63 x 1 1/2" x 63	113	268	113	22	83	—	20	828
0784060630200A	63 x 2" x 63	113	272	110	26	92	—	20	877

90° Reducing Tee with Threaded Female Offtake

07140

Te de 90° reducción compresión rosca hembra

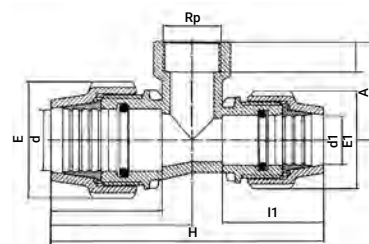

Product Code	Size d x Rp x d1	E	E1	H	L	I	I1	I2	A	UB	UC	W
0714S60200160A	20 x 3/4" x 16	48	39	132	69	52	50	19	42	10	180	86
0714S60250200A	25 x 3/4" x 20	54	48	139	70	53	52	22	42	5	140	145
0714S60320250A	32 x 1" x 25	64	54	169	91	67	58	22	58	5	80	176

90° Tee with Threaded Female Offtake

07140

Te de 90° compresión rosca hembra

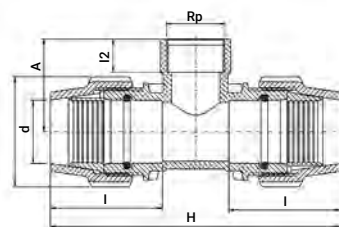

Product Code	Size d x Rp x d	E	H	I	I2	A	UB	UC	W
0714060160050A	16 x 1/2" x 16	39	122	50	17	42	10	240	66
0714060160070A	16 x 3/4" x 16	39	122	50	19	41	10	240	65
0714060200050A	20 x 1/2" x 20	48	144	56	18	42	10	180	104
0714060200070A	20 x 3/4" x 20	48	144	56	19	45	10	180	110
0714060250050A	25 x 1/2" x 25	54	151	58	18	45	5	140	131
0714060250070A	25 x 3/4" x 25	54	151	58	19	48	5	140	140
0714060250100A	25 x 1" x 25	54	158	58	21	53	5	100	140
0714060250130A	25 x 1 1/4" x 25	54	158	58	25	64	5	80	194
0714060320070A	32 x 3/4" x 32	64	177	67	19	51	5	80	210
0714060320100A	32 x 1" x 32	64	177	67	21	54	5	80	213
0714060320130A	32 x 1 1/4" x 32	64	182	67	25	65	5	60	253
0714060320150A	32 x 1 1/2" x 32	64	182	67	25	71	5	60	268
0714060400100A	40 x 1" x 40	82	203	84	21	61	—	60	357
0714060400130A	40 x 1 1/4" x 40	82	217	84	24	70	—	55	403
0714060400150A	40 x 1 1/2" x 40	82	217	84	25	70	—	50	413
0714060400200A	40 x 2" x 40	82	217	84	30	78	—	45	435
0714060500150A	50 x 1 1/2" x 50	96	244	93	25	76	—	36	575
0714060500200A	50 x 2" x 50	96	244	93	30	80	—	30	590
0714060630130A	63 x 1 1/4" x 63	113	268	113	27	95	—	20	886
0714060630150A	63 x 1 1/2" x 63	113	268	113	27	95	—	20	898
0714060630200A	63 x 2" x 63	113	272	110	30	95	—	20	903
0714060750200A	75 x 2" x 75	134	359	132	30	110	—	10	1456
0714060750250A	75 x 2 1/2" x 75	134	331	129	35	85	—	10	1502
0714060750300A	75 x 3" x 75	134	359	132	36	110	—	10	1553
0714060900300A	90 x 3" x 90	154	419	165	40	116	—	7	2354
0714061100400A	110 x 4" x 110	181	511	198	50	140	—	4	3957

90° Slip Tee with Threaded Female Offtake

0714P0

Te de 90° roscas hembra de reparación

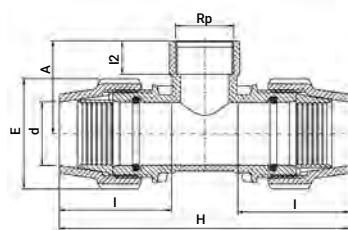

Product Code	Size d x Rp x d	E	H	I	I2	A	UB	UC	W
0714P60400100A	40 x 1" x 40	82	203	84	21	61	—	60	361
0714P60500150A	50 x 1 1/2" x 50	96	244	93	25	76	—	36	587
0714P60630130A	63 x 1 1/4" x 63	113	268	113	27	95	—	20	860

Coupling with Riser

07810

Enlace recto con derivación rosca macho

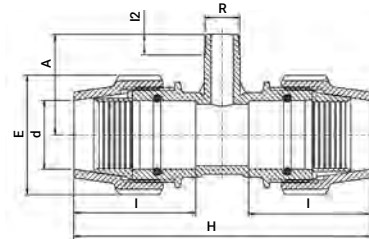

Product Code	Size d x R x d	E	I	I2	H	A	UB	UC	W
0781060400070A	40 x 3/4" x 40	82	89	18	215	85	—	50	366
0781060500070A	50 x 3/4" x 50	96	98	18	244	90	—	36	512
0781060500100A	50 x 1" x 50	96	98	20	244	90	—	36	551
0781060630070A	63 x 3/4" x 63	113	110	18	270	95	—	24	822
0781060630100A	63 x 1" x 63	113	110	20	270	95	—	24	820
0781060750070A	75 x 3/4" x 75	134	132	18	313	105	—	16	1123
0781060750100A	75 x 1" x 75	134	132	20	313	105	—	16	1240

45° Tee

07640

Te de 45°

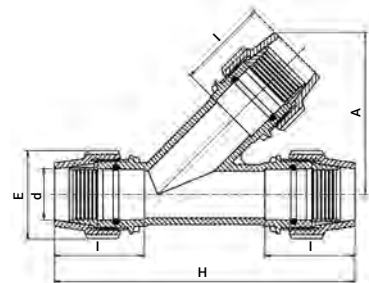

Product Code	Size d x d x d	E	H	I	A	UB	UC	W
0764060630A	63 x 63 x 63	113	374	110	207	—	10	1432
0764060750A	75 x 75 x 75	132	435	132	204	—	5	2266
0764060900A	90 x 90 x 90	152	520	165	233	—	4	3600
0764061100A	110 x 110 x 110	181	625	194	284	—	2	6000

Compression Flange Adaptor (with Metal Flange)

07220*

Adaptador compresión-brida (con brida de metal)

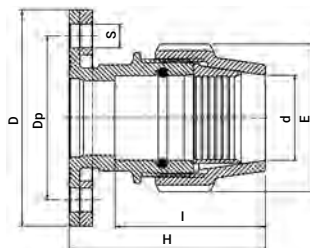

Product Code	Size d x DN (inch)	E	H	I	D	Dp	S	No. of Holes	Metal-Flange Size	UC	W
0722060400150A	40 x 40 (1 1/2")	82	119	93	150	110	18	4	40 x 40	20	1200
0722060500150A	50 x 40 (1 1/2")	96	128	93	150	110	18	4	50 x 40	20	1213
0722060500200A	50 x 50 (2")	96	128	93	165	125	18	4	50 x 50	15	1517
0722060630200A	63 x 50 (2")	113	145	110	165	125	18	4	63 / 75 x 50	15	1563
0722060750250A	75 x 65 (2 1/2")	134	164	152	185	145	18	4	75 / 90 x 65	12	2089
0722060900300A	90 x 80 (3")	154	195	183	200	160	18	8	90 / 110 x 80	10	2533
0722060900400A	90 x 100 (4")	154	195	183	220	180	18	8	90 x 100	8	3161
0722061100400A	110 x 100 (4")	181	235	222	220	180	18	8	110 x 100	8	3322
0722061250500A	125 x 125 (5")	212	270	250	250	210	22	8	125 / 160 x 125	4	5550
0722061250600A	125 x 150 (6")	212	270	250	285	240	22	8	125 / 160 x 150	3	7037

* 072210 - Compression Flange Adaptor without metal flange | * 072210 - Sin brida de metal

Flange Adaptor (with Metal Flange)

072306*

Adaptador espiga-brida (con brida de metal)

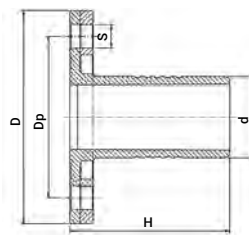

Product Code	Size d x DN (inch)	H	D	Dp	S	No. of Holes	Metal-Flange Size	UC	W
0723060500150A	50 x 40 (1 1/2")	99	150	110	18	4	50 x 40	20	1064
0723060500200A	50 x 50 (2")	99	165	125	18	4	50 x 50	20	1094
0723060630200A	63 x 50 (2")	124	165	125	18	4	63 / 75 x 50	18	1311
0723060630250A	63 x 65 (2 1/2")	124	185	145	18	4	63 x 65	15	1882
0723060750200A	75 x 50 (2")	142	165	125	18	4	63 / 75 x 50	15	1402
0723060750250A	75 x 65 (2 1/2")	142	185	145	18	4	75 / 90 x 65	15	1568
0723060750300A	75 x 80 (3")	142	200	160	18	8	75 x 80	12	1981
0723060900250A	90 x 65 (2 1/2")	175	185	145	18	4	75 / 90 x 65	12	1833
0723060900300A	90 x 80 (3")	175	200	160	18	8	90 / 110 x 80	12	1858
0723060900400A	90 x 100 (4")	175	220	180	18	8	90 x 100	10	2181
0723061100300A	110 x 80 (3")	210	200	160	18	8	90 / 110 x 80	10	2020
0723061100400A	110 x 100 (4")	210	220	180	18	8	100 x 100	8	2275
0723061100500A	110 x 125 (5")	214	250	210	18	8	110 x 125	6	3988

* 072301 - Flange adaptor without metal flange | * 072301 - Sin brida de metal

Metal Flange

07006

Brida de metal

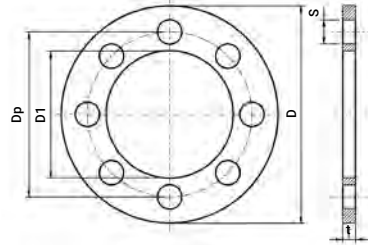

Product Code	Size d x DN (inch)	D	Dp	D1	S	t	Th* (mm)	Th* (inch)	No. of Holes	UC	W
070060050015P	50 x 40 (1 1/2")	150	110	82	18	10	M16	37472	4	20	844
070060050020P	50 x 50 (2")	165	125	82	18	10	M16	37472	4	20	1141
070060063025P	63 x 65 (2 1/2")	185	145	96	18	10	M16	37472	4	20	1420
070060075020P	63 / 75 x 50 (2")	165	125	96	18	10	M16	37472	4	20	986
070060075025P	75 / 90 x 65 (2 1/2")	185	145	112	18	10	M16	37472	4	20	1350
070060075030P	75 x 80 (3")	200	160	112	18	10	M16	37472	8	15	1430
070060090030P	90 / 110 x 80 (3")	200	160	132	18	10	M16	37472	8	15	1215
070060090040P	90 x 100 (4")	220	180	132	18	10	M16	37472	8	15	1720
070060110040P	110 x 100 (4")	220	180	151	18	10	M16	37472	8	15	1416
070060110050P	110 x 125 (5")	250	210	151	18	10	M16	37472	8	15	2850

* Nominal diameter of bolts | * Diametro nominal del tornillo

Special design for PLASSON flange adaptors

Threaded Adaptor

07250*

Adaptador compresión rosca macho

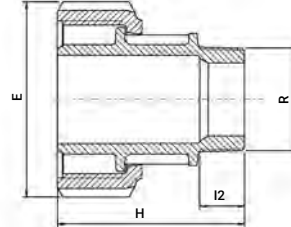

Product Code	Size d x R	E	H	I2	UB	UC	W
0725060250050A	25 x 1/2"	54	79	17	1	200	36
0725060250070A	25 x 3/4"	54	80	18	1	200	36
0725060320050A	32 x 1/2"	64	85	17	1	180	66
0725060320070A	32 x 3/4"	64	86	18	1	180	65
0725060320100A	32 x 1"	64	87	20	1	180	68
0725060400100A	40 x 1"	82	99	20	1	130	108
0725060400130A	40 x 1 1/4"	82	100	22	1	130	112
0725060400150A	40 x 1 1/2"	82	100	22	1	130	113
0725060500100A	50 x 1"	96	102	20	1	80	147
0725060500130A	50 x 1 1/4"	96	104	24	1	80	154
0725060500150A	50 x 1 1/2"	96	104	24	1	80	156
0725060500200A	50 x 2"	96	107	27	1	80	158
0725060630100A	63 x 1"	113	108	20	1	60	228
0725060630130A	63 x 1 1/4"	113	111	22	1	60	230
0725060630150A	63 x 1 1/2"	113	111	22	1	60	230
072506063020603A	63 x 2"	113	114	26	1	60	258
0725060630250A	63 x 2 1/2"	113	116	29	1	60	250
0725060750150A	75 x 1 1/2"	134	128	22	1	30	404
0725060750200A	75 x 2"	134	132	26	1	30	402
0725060750250A	75 x 2 1/2"	134	134	29	1	30	412
0725060750300A	75 x 3"	134	137	33	1	30	430

* Threaded Adaptor Body Cat. No. 078901. Threaded Adaptor Nut - Cat. No. 078940

* Cuerpo del adaptador roscado - Cat. No. 078901. Racor para el adaptador roscado - Cat. No. 078940

Brass Threaded Adaptor

07270

Adaptador rosca de latón

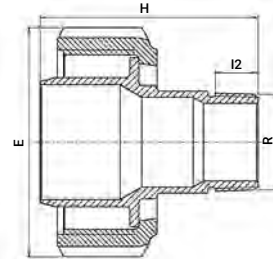

Product Code	Size d x R	I2	H	E	UB	UC	W
072706032010	32 x 1"	19	77	64	1	50	279
072706040010	40 x 1"	19	81	82	1	50	363
072706040013	40 x 1 1/4"	21	90	82	1	50	487
072706050013	50 x 1 1/4"	21	95	96	1	30	523
072706050015	50 x 1 1/2"	21	97	96	1	30	554
072706063013	63 x 1 1/4"	21	105	113	1	20	767
072706063020	63 x 2"	25	112	113	1	20	985

Brass Threaded Adaptor NPT

0727T0

Adaptador rosca de latón

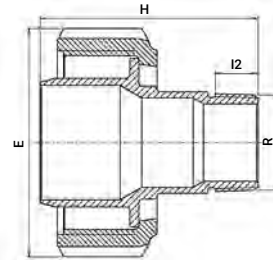

Product Code	Size d x NPT	I2	H	E	UB	UC	W
0727T0032010	32 x 1"	19	77	64	1	50	279
0727T0063020	63 x 2"	25	112	113	1	20	985

Plas4 Coupling (Universal)

070170

Plas4 Enlace (universal)

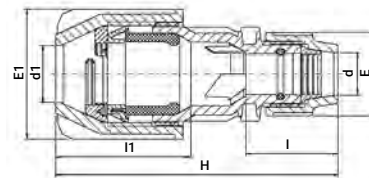

Product Code	Size d x d1	E	E1	I	I1	H	UB	UC	W
0701760200270A	20 x 20 - 27	48	71	57	85	169	1	80	206
0701760250220A	25 x 15 x 22	54	64	58	80	165	1	90	183
0701760250270A	25 x 20 x 27	54	71	58	85	170	1	80	216
0701760250350A	25 x 27 x 35	54	83	58	90	180	1	60	281
0701760320270A	32 x 20 x 27	64	71	67	85	180	1	70	240
0701760320350A	32 x 27 x 35	64	83	67	90	195	1	60	312
0701760500500A	50 x 35 - 50	96	121	93	125	270	1	20	901

Plas4 (Universal) 90° Elbow

070570

Plas4 - Codo de 90° (universal)

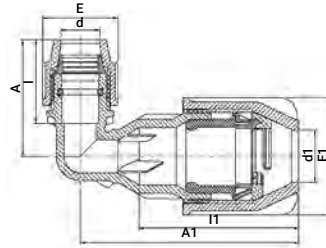

Product Code	Size d x d1	E	E1	I	I1	A	A1	UB	UC	W
0705760200270A	20 x 20 - 27	54	71	60	105	83	139	1	80	292
0705760250220A	25 x 15 - 22	54	64	58	105	81	128	1	80	198
0705760250270A	25 x 20 - 27	54	71	58	105	81	139	1	70	238
0705760250350A	25 x 27 - 35	54	83	58	112	81	153	1	55	305

Y Fitting with Threaded Male Offtake

07550

Y compresión rosca macho

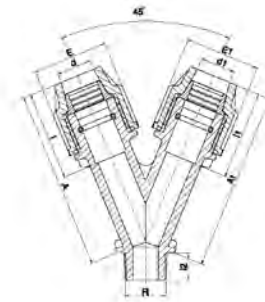

Product Code	Size d x d1 x R	E	E1	I	I1	I2	A	A1	UB	UC	W
0755060160070A	16 x 16 x 3/4"	39	39	50	50	18	100	100	10	200	75
0755060200160A	20 x 16 x 3/4"	48	39	57	50	18	108	105	10	180	103
0755060200070A	20 x 20 x 3/4"	48	48	57	57	18	114	114	10	120	130
0755060250070A	25 x 25 x 3/4"	54	54	58	58	18	125	125	5	100	154

Cross with Threaded Female Offtake

07540

Cruz compresión rosca hembra

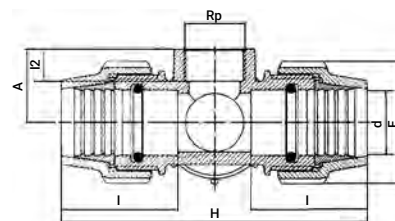

Product Code	Size d x d x d x d x Rp	E	I	I2	H	A	UB	UC	W
0754060200070A	20 x 20 x 20 x 20 x 3/4"	48	57	21	149	35	5	80	204

Plug Adaptor

071209

Tapón ciego

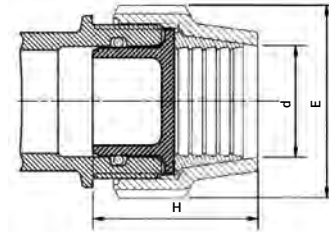

Product Code	Size d	E	H	UB	UC	W
0712090200A	20	48	47	10	1800	5
0712090250A	25	54	51	10	1500	8
0712090320A	32	64	56	10	1000	15
0712090400A	40	82	66	10	720	24
0712090500A	50	96	80	10	400	41
0712090630A	63	113	96	10	200	76

Pipe Liner for PE SDR 11 Pipe

07950

Refuerzo de tubos

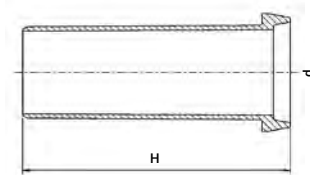

Product Code	Size d*	H	UB	UC	W
079500020	20 x 1.9	63	10	2520	5
079500025	25 x 2.3	63	10	1680	10
079500032	32 x 3.0	79	10	920	13
079500040	40 x 3.7	97	10	480	25
079500050	50 x 4.6	106	10	240	45
079500063	63 x 5.8	125	5	110	72

* O.D. of pipe x wall thickness of pipe | * Diametro externo del tubo x espesor del tubo

Adaptor for Copper and Imperial UPVC

07896*

Adaptador para cobre y PVCU

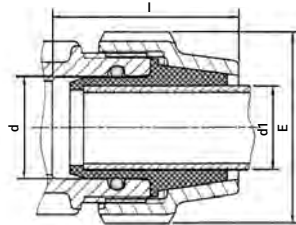

Product Code	Size d x d1	E	I	UB	UC	W
07896015P	20 x 15	48	66	25	1500	15
07896022P	25 x 22	54	64	20	1200	15
07896028P	32 x 28	64	74	20	700	27
07896035P	40 x 35	82	92	10	240	54
07896042P	50 x 42	96	105	10	160	111

* No Pull-Out Resistance | * Sin resistencia a la tracción

Reducing Set

07930

Juego reductor

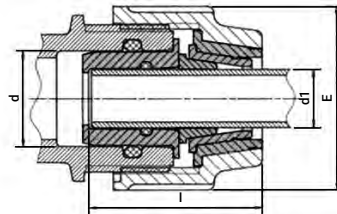

Product Code	Size d x d1	E	I	UB	UC	W
0793000250200A	25 x 20	54	56	—	300	22
0793000320200A	32 x 20	64	62	—	300	38
0793000320250A	32 x 25	64	60	—	250	35
0793000400200A	40 x 20	82	73	—	180	62
0793000400250A	40 x 25	82	69	—	180	81
0793000400320A	40 x 32	82	77	—	200	62
0793000500250A	50 x 25	96	85	—	120	114
0793000500320A	50 x 32	96	87	—	120	112
0793000500400A	50 x 40	96	85	—	120	97
0793000630250A	63 x 25	113	103	—	80	217
0793000630320A	63 x 32	113	102	—	80	214
0793000630400A	63 x 40	113	103	—	80	201
0793000630500A	63 x 50	113	105	—	80	187
0793001100630A	110 x 63	181	131	—	24	703

* Reducer made of polypropylene | * Reductor de pp

Modular Adaptor

07940

Adaptador modulado

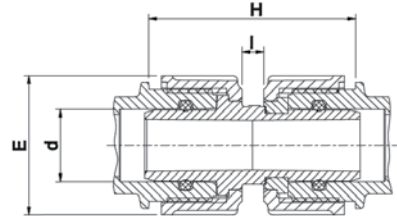

Product Code	Size d	E	H	I	UB	UC	W
0794060200A	20	48	80	10	10	300	50
0794060250A	25	54	80	10	10	250	61
0794060320A	32	64	93	10	5	180	104
0794060400A	40	82	102	10	5	100	173
0794060500A	50	93	107	10	—	70	257
0794060630A	63	113	119	10	—	45	422

Copper Pipe Adaptor

0701C6

Adaptador para tubo de cobre

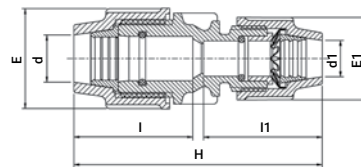

Product Code	Size d (PE) x d1 (Cu)	E	E1	H	I	I1	UB	UC	W
0701C6020015	20 x 15	48	39	115	56	54	—	200	103
0701C6025015	25 x 15	54	39	124	55	54	—	180	86
0701C6025022	25 x 22	54	54	136	60	71	—	150	132
0701C0032028	32 x 28	64	64	150	70	77	—	100	199

Grip Ring for UPVC and PP pipe

07970

Casquillo de apriete para tubos de UPVC y PP



Product Code	Size d	UB	UC	W
07970020	20	–	10000	1
07970025	25	–	10000	2
07970032	32	–	10000	3
07970040	40	–	1000	6
07970050	50	–	1000	10
07970063	63	–	1000	17

Conversion Set for Copper Pipe (Europe + UK dimensions)

074380

Juego adaptador para tubos de cobre

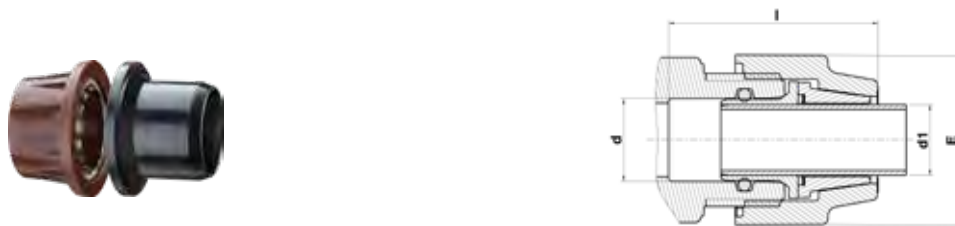

Product Code	Size d x d1	E	I	UB	UC	W
07438015	20 x 15	48	67	10	360	20
07438016	25 x 15	54	69	10	360	29
07438022	25 x 22	54	67	10	360	25
07438028	32 x 28	64	77	10	300	27
07438035	35 x 40	82	92	10	300	38
07438042	42 x 50	96	105	10	250	64
07438054	54 x 63	113	121	1	150	102

Conversion set for copper pipe (CTS dimensions)

Dimensiones CTS

Product Code	Size d x d1	E	I	UB	UC	W
07439204	20 x 1/2" (O.D. 15.8mm)	48	67	10	600	20
07438022	25 x 3/4" (O.D. 22.2mm)	54	69	10	500	33

Conversion set for Copper pipe (Australian AS1432 dimensions)

Dimensiones Australianas (AS 1432)

Product Code	Size d x d1	E	I	UB	UC	W
07439205	20 x 15 (1/2") (O.D. 12.7mm)	48	67	1	300	42
07439257	25 x 20 (3/4") (O.D. 19.5mm)	54	69	1	250	51
07439251	25 x 25 (1") (O.D. 25.4mm)	54	69	1	250	34

Coupling for PVC Pipe

0701QQ

Enlace recto para tubo de PVC

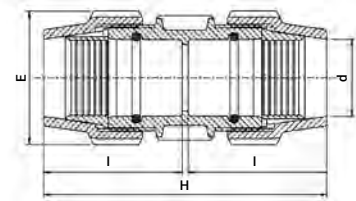

Product Code	Size d x d	E	H	I	UB	UC	W
0701QQ090	90 x 90	154	335	165	—	10	1898
0701QQ110	110 x 110	181	393	194	—	5	3129
0701QQ125	125 x 125	212	460	225	—	3	5347

Conversion Set for Lead Pipe

077802

Juego adaptador para tubos de plomo

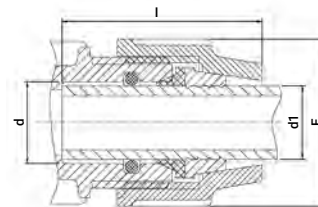

Product Code	Size d x d1	E	I	UB	UC	W
077802025003	25 x 3/8" 5 LB	54	67	5	1000	15
077802025005	25 x 1/2" 7 LB	54	64	5	1500	8
077802032005	32 x 1/2" 9 LB	64	77	5	500	24
077802032007	32 x 3/4" 9 LB	64	76	5	1000	13
077802040007	40 x 3/4" 11 LB	82	95	5	400	42
077802050010	50 x 1" 16 LB	96	104	5	250	68

Converter Rubber Adaptor for steel and galvanized pipe 078908*

Conversor de goma para tubos de acero galvanizado

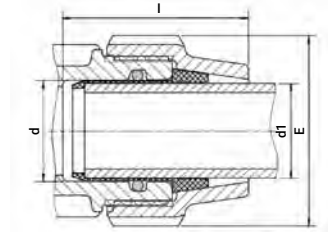

Product Code	Size d x d1	E	I	UB	UC	W
078908010	40 x 1"	82	89	5	200	60
078908013	50 x 1 1/4"	96	98	5	150	89
078908015	50 x 1 1/2"	96	90	5	150	35
078908020	63 x 2"	113	108	5	120	71

* Without pullout resistance | * Extraccion sin resistencia

Conversion Set Adaptor for steel and galvanized pipe 078907

Juego de conversion para tubos de acero galvanizado

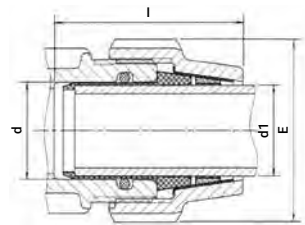

Product Code	Size d x d1	E	I	UB	UC	W
078907010	40 x 1"	82	96	5	200	117
078907013	50 x 1 1/4"	96	105	5	150	150
078907015	50 x 1 1/2"	96	115	5	150	125
078907020	63 x 2"	113	117	5	100	226

Pipe Conversion Chart

Metric PE / Metric U-PVC / Metric PP / Galvanised Steel / Lead Pipe / Imperial U-PVC/Copper

PE métrico / PP y PVCU métrico / Acero galvanizado / Plomo / U-PVC imperial / Cobre...

The basic fitting is a dedicated product for joining metric PE pipe. It will securely join the pipe without any additional components. The fittings can be easily converted for use with other materials simply by adding a conversion set. PLASSON offers a full range of conversion sets to provide exceptional adaptability.

El accesorio básico es un producto dedicado a conectar tuberías de PE sin componentes adicionales, con la máxima seguridad. Los accesorios se pueden ser convertidos facilmente a cualquier tipo de tubería usando un juego de conversión. PLASSON ofrece una gama que permite una adaptabilidad excepcional.

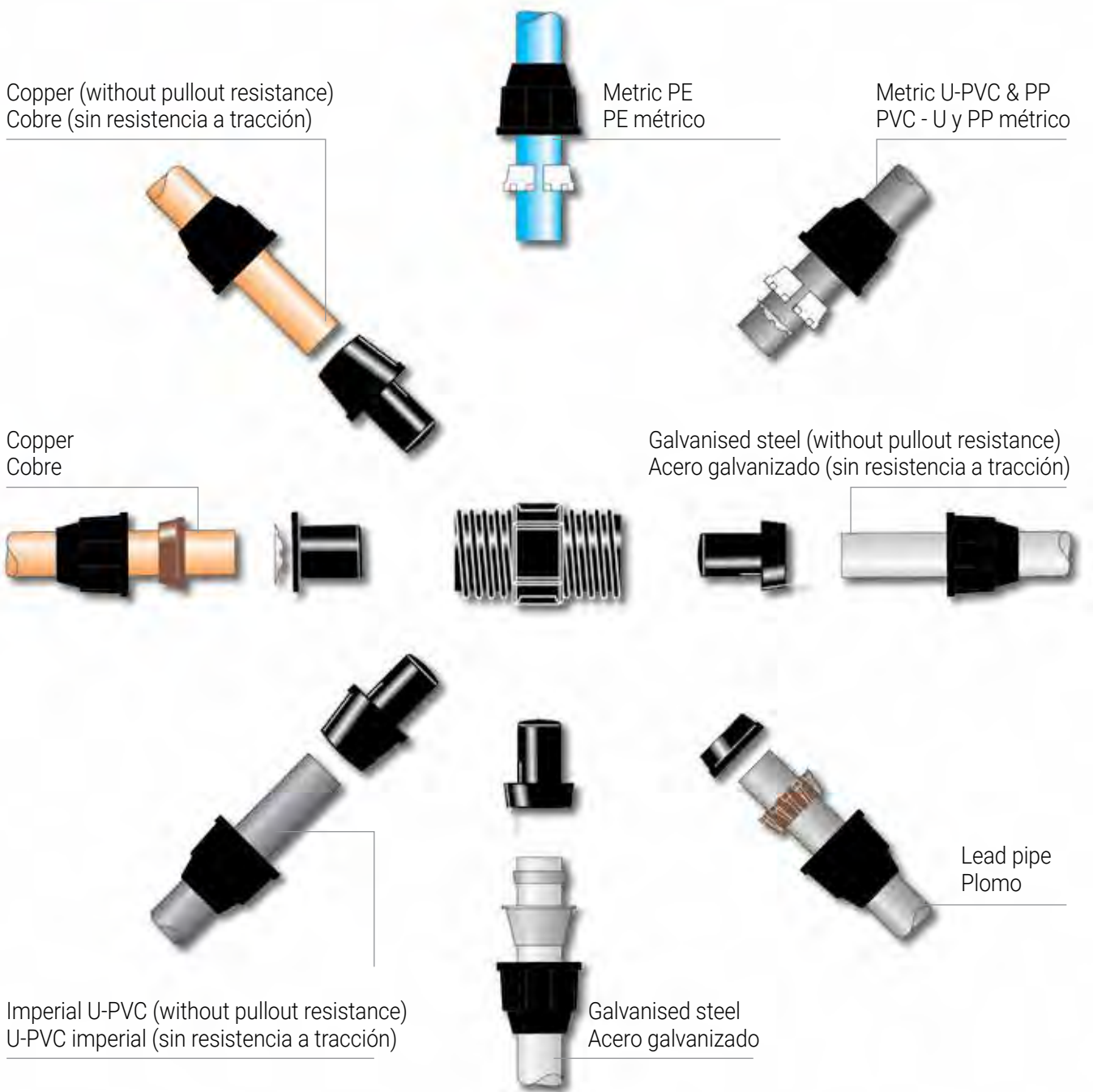

Nut

07004

Racor

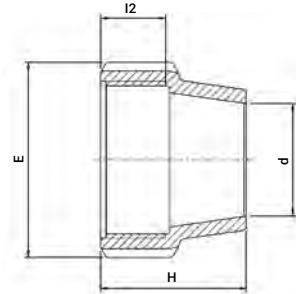

Product Code	Size d	E	H	I2	UB	UC	W
070046016P	16	39	40	23	10	1000	12
070046020P	20	48	45	26	10	700	22
070046025P	25	54	46	26	10	500	26
070046032P	32	64	51	30	5	300	41
070046040P	40	82	63	34	—	200	70
070046050P	50	96	71	34	—	125	104
070046063P	63	113	89	43	—	100	171
070046075P	75	132	110	56	—	64	279
070046090P	90	152	135	73	—	36	435
070046110P	110	181	170	97	—	16	752
070046125P	125	212	185	107	—	10	1135

O - Ring NBR

07002

Junta tórica (NBR)

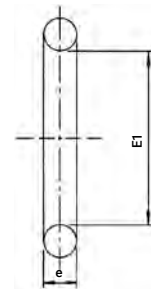

Product Code	Size d	E1	e	UB	UC	W
070020016	16	15	3	—	30000	1
070020020	20	19	3	—	32000	1
070020025	25	24	4	—	12000	1
070020032	32	31	5	—	10000	2
070020040*	40	39	6	—	4000	5
070020050*	50	49	6	—	2500	8
070020063*	63	62	7	—	2000	10
070020075	75	74	8	—	1600	16
070020090	90	89	8	—	1500	17
070020110	110	108	9	—	900	27
070020125	125	122	10	—	700	50

* Only for slip repair coupling and tee

O - Ring EPDM (Blue Mark)

07002D0

Junta tórica EPDM, (marca azul)

Product Code	Size d	E1	e	UB	UC	W
07002D016	16	15	3	100	30000	1
07002D020	20	19	3	100	16000	1
07002D025	25	24	4	100	16000	1
07002D032	32	31	5	100	8000	2
07002D040*	40	39	6	20	4000	4
07002D050*	50	49	6	20	2500	7
07002D063*	63	62	7	20	2000	8
07002D075	75	74	8	10	1600	16
07002D090	90	89	8	10	1400	17
07002D110	110	108	9	10	900	27

* Only for slip repair coupling and tee

O - Ring Viton FPM (White Mark)

07002V0

Junta tórica FPM, (marca blanca)

Product Code	Size d	E1	e	UB	UC	W
03050905	16	15	3	100	30000	2
07002V020	20	19	3	100	32000	2
07002V025	25	24	4	100	16000	2
07002V032	32	31	5	100	8000	4
07002V040*	40	39	6	20	4000	7
07002V050*	50	49	7	20	2500	12
07002V063*	63	62	7	20	2000	15
07002V075	75	74	8	10	1600	23
07002V090	90	89	8	10	1400	28
07002V110	110	108	9	10	900	43

* Only for slip repair coupling and tee

Seal - NBR

070029

Sello de NBR

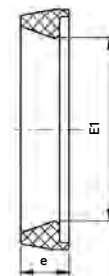

Product Code	Size d	E1	e	UB	UC	W
070029040	40	38	8	50	2600	4
070029050	50	49	9	50	1600	8
070029063	63	62	9	50	1500	9

Seal EPDM (Blue Mark)

07002D9

Sello EPDM, (marca azul)

Product Code	Size d	E1	e	UB	UC	W
07002D940	40	38	8	20	4000	4
07002D950	50	49	9	20	2500	7
07002D963	63	62	9	20	2000	9

Seal Viton FPM (White Mark)

07002V9

Sello de Viton FPM, (marca blanca)

Product Code	Size d	E1	e	UB	UC	W
07002V940	40	38	8	20	4000	7
07002V950	50	49	9	20	2500	12
07002V963	63	62	9	20	2000	14

Split Ring - Polyacetal

07003

Casquillo de apriete (acetal)

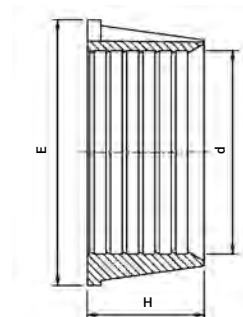

Product Code	Size d	E	H	UB	UC	W
070030016P	16	23	12	100	12000	1
070030020P	20	31	13	100	6500	3
070030025P	25	36	13	100	4500	4
070030032P	32	44	19	50	2000	7
070030040P	40	55	24	50	1200	12
070030050P	50	67	30	20	500	24
070030063P	63	83	37	10	300	46
070030075P	75	96	37	10	200	48
070030090P	90	115	56	5	115	111
070030110P	110	135	56	5	70	151
070030125P	125	161	72	—	35	291

Split Ring - CPVC

07003V

Casquilla de apriete (CPVC)

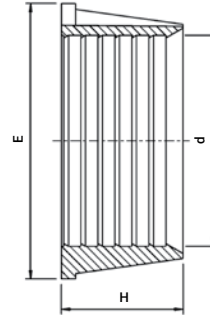

Product Code	Size d	E	H	UB	UC	W
07003V016P	16	23	12	100	12000	3
07003V020P	20	31	13	100	6500	4
07003V025P	25	36	13	100	4500	5
07003V032P	32	44	19	50	1500	11
07003V040P	40	55	24	—	1200	19
07003V050P	50	67	30	—	500	32
07003V063P	63	83	37	—	300	53
07003V075P	75	96	37	—	200	71
07003V090P	90	115	56	—	100	126
07003V110P	110	135	56	—	70	150

Split Ring for PVC Pipe

07003Q

Garra para tubo de PVC

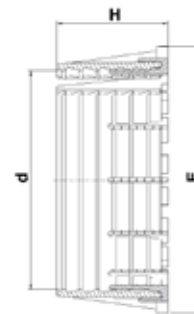

Product Code	Size d	UB	UC	W
07003Q0075P	75	1	85	—
07003Q0030P	90	1	100	112
07003Q0110P	110	1	60	148
07003Q0125P	125	1	35	260

Insert

07005

Inserto de PP

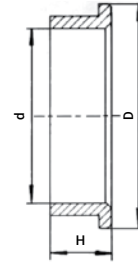

Product Code	Size d	D	H	UB	UC	W
070050016P	16	17	12	100	8700	1
070050020P	20	29	10	100	5000	1
070050025P	25	36	11	100	4000	3
070050032P	32	45	11	100	4000	6
070050075P	75	94	17	—	300	31
070050090P	90	116	25	—	160	56
070050110P	110	138	30	—	100	81
070050125P	125 Upper	164	48	—	80	153
070051125P	125 Lower	142	18	—	160	204

Chamfer Tool for PE Pipes

18960

Herramienta para biselar



Product Code	Size	UB	UC	W
189600063020P	20 - 63	—	64	202

Chamfer Tool for PE Pipes

07960

Herramienta para biselar



Product Code	Size	UB	UC	W
079600063020	20 - 63	1	180	86

PLASSON Wrench

07990

Llave PLASSON



Product Code	Size	UB	UC	W
07990001	16 - 40	–	250	65
07990005	40 - 75	–	75	296
07990000	63 - 125	–	40	840

Coupling

070106

Racor

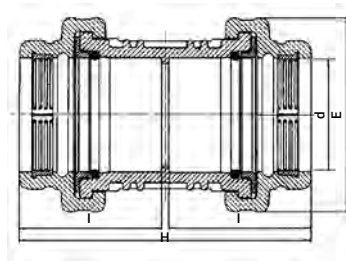

Product Code	Size d x d	E	I	H	UB	UC	W
0701061600A	160 x 160	280	204	418	–	2	888

Repair Coupling

076106

Enlace recto de reparación

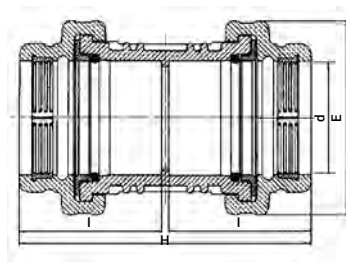

Product Code	Size d x d	E	I	H	UB	UC	W
0761061600A	160 x 160	280	204	418	–	2	9170

90° Tee

070406

Te de 90°

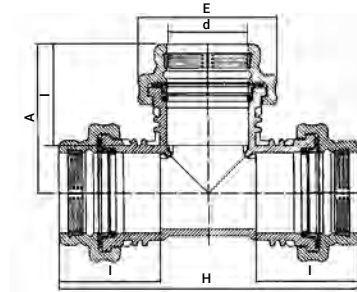

Product Code	Size d x d x d	E	I	H	A	UB	UC	W
0704061600A	160 x 160 x 160	280	204	601	301	—	1	14738

90° Elbow

070506

Codo de 90°

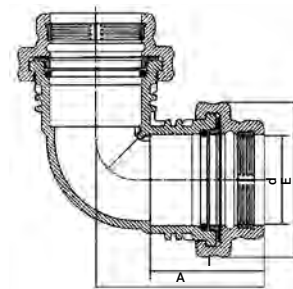

Product Code	Size d x d	E	I	A	UB	UC	W
0705061600A	160 x 160	280	204	301	—	2	10008

Compression Flange Adaptor (with Metal Flange)

072206

Adaptador compresión-brida (con brida de metal)

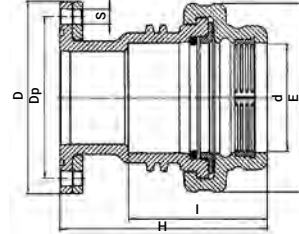

Product Code	Size d x DN (inch)	E	H	I	D	Dp	S	No. of Holes	Metal-Flange Size	UC	W
0722061600500A	160 x 125 (5")	280	304	204	250	210	18	8	125 / 160 x 125	3	7700
0722061600600A	160 x 150 (6")	280	304	204	285	240	22	8	125 / 160 x 150	3	9151

Flange Adaptor (with Metal Flange)

072306

Adaptador brida (con brida de metal)

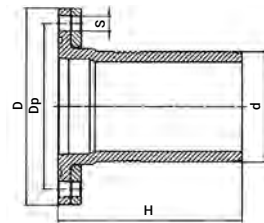

Product Code	Size d x DN (inch)	H	D	Dp	S	No. of Holes	Metal-Flange Size	UC	W
0723061600500A	160 x 125 (5")	265	250	210	18	8	125 / 160 x 125	6	4345
0723061600600A	160 x 150 (6")	265	285	240	22	8	125 / 160 x 150	5	5650

Shouldered Adaptor

073206

Adaptador minero

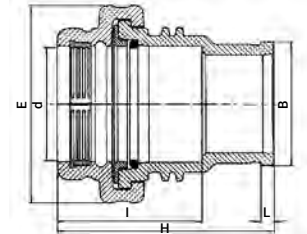

Product Code	Size d x DN (inch)	E	H	I	L	B	UB	UC	W
0732061600600A	160 x 150 (6")	280	304	204	18	175	—	4	5170

Half Metal Flange

070060160

Brida de metal

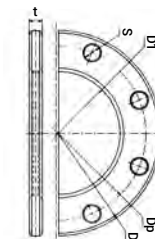

Product Code	Size d x DN (inch)	D	Dp	D1	S	t	Th* (mm)	Th* (inch)	No. of Holes	W
070060160050P	125 / 160 x 125 (5")	250	210	170	18	12	M16	5/8	8	1100
070060160060P	125 / 160 x 150 (6")	250	240	170	22	12	M20	3/4	8	1800

* Nominal diameter of bolts | * Diametro nominal del tornillo

Saddle Single Outlet with Reinforcing Ring Options

16076

Collarin simple con anillo de refuerzo

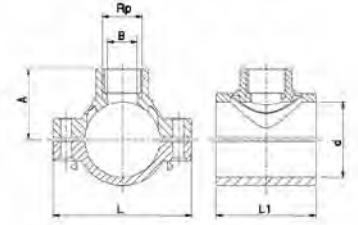

Product Code	Size d x Rp	B	L	H	A	No. of Bolts	UB	UC	W
160760020005	20 x 1/2"	10	70	45	33	2	1	400	63
160760025005	25 x 1/2"	15	75	50	36	2	1	300	70
160760025007	25 x 3/4"	15	75	50	37	2	1	300	73
160760032005	32 x 1/2"	16	92	60	40	2	1	150	133
160760032007	32 x 3/4"	19	92	60	41	2	1	150	135
160760032010	32 x 1"	20	92	60	42	2	1	150	142
160760040005	40 x 1/2"	16	92	60	45	2	1	150	141
160760040007	40 x 3/4"	19	92	60	46	2	1	150	143
160760040010	40 x 1"	25	92	60	49	2	1	150	151
160760050005	50 x 1/2"	16	106	73	51	2	1	100	179
160760050007	50 x 3/4"	21	106	73	52	2	1	100	180
160760050010	50 x 1"	25	106	73	54	2	1	100	187
160760050013	50 x 1 1/4"	25	106	73	58	2	1	100	212
160760063005	63 x 1/2"	16	116	84	58	4	1	70	278
160760063007	63 x 3/4"	20	116	84	59	4	1	70	279
160760063010	63 x 1"	25	116	84	61	4	1	70	286
160760063013	63 x 1 1/4"	32	116	84	66	4	1	70	308
160760063015	63 x 1 1/2"	39	116	84	67	4	1	60	322
160760075005	75 x 1/2"	16	122	98	64	4	1	60	369
160760075007	75 x 3/4"	20	122	98	65	4	1	55	369
160760075010	75 x 1"	25	122	98	67	4	1	55	376
160760075013	75 x 1 1/4"	32	122	98	72	4	1	55	398
160760075015	75 x 1 1/2"	40	122	98	73	4	1	45	411
160760075020	75 x 2"	40	122	98	78	4	1	40	433
160760090005	90 x 1/2"	16	141	105	72	4	1	40	453
160760090007	90 x 3/4"	20	141	105	73	4	1	40	454
160760090010	90 x 1"	25	141	105	75	4	1	40	460
160760090013	90 x 1 1/4"	32	141	105	80	4	1	40	483
160760090015	90 x 1 1/2"	40	141	105	81	4	1	40	467
160760090020	90 x 2"	50	141	105	86	4	1	40	511
160760110005	110 x 1/2"	16	165	116	83	4	1	45	561
160760110007	110 x 3/4"	20	165	116	84	4	1	45	562
160760110010	110 x 1"	25	165	116	87	4	1	36	567
160760110013	110 x 1 1/4"	32	165	116	91	4	1	36	588
160760110015	110 x 1 1/2"	40	165	116	92	4	1	36	600
160760110020	110 x 2"	50	165	116	97	4	1	30	615
160760125007	125 x 3/4"	20	184	124	91	6	1	30	762
160760125010	125 x 1"	25	184	124	94	6	1	30	755
160760125013	125 x 1 1/4"	32	184	124	98	6	1	30	778
160760125015	125 x 1 1/2"	40	184	124	99	6	1	30	781
160760125020	125 x 2"	50	184	124	104	6	1	25	796
160760140010	140 x 1"	25	201	136	101	6	1	24	893
160760140013	140 x 1 1/4"	32	201	136	106	6	1	24	912
160760140015	140 x 1 1/2"	40	201	136	107	6	1	24	922
160760140020	140 x 2"	50	201	136	112	6	1	20	938
160760160010	160 x 1"	25	223	145	112	6	1	20	1039
160760160013	160 x 1 1/4"	32	223	145	117	6	1	20	1061
160760160015	160 x 1 1/2"	40	223	145	118	6	1	20	1071
160760160020	160 x 2"	50	223	145	123	6	1	20	1080
160760180010	180 x 1"	25	245	154	122	6	1	16	1314
160760180013	180 x 1 1/4"	32	245	154	127	6	1	16	1319
160760180015	180 x 1 1/2"	40	245	154	128	6	1	16	1349
160760180020	180 x 2"	50	245	154	133	6	1	16	1334

* With coated steel bolts, Stainless steel bolts – optional

Saddle Double Outlet with Reinforcing Ring Options

16176

Collarin doble con anillo de refuerzo

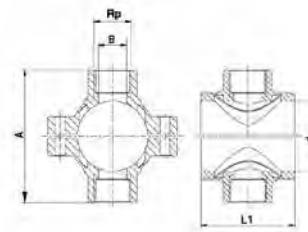

Product Code	Size d x Rp	B	L	L1	A	No. of Bolts	UB	UC	W
161760020005	20 x 1/2"	10	70	45	66	2	1	300	73
161760025005	25 x 1/2"	15	75	50	71	2	1	250	81
161760025007	25 x 3/4"	15	75	50	73	2	1	250	86
161760032005	32 x 1/2"	16	92	60	80	2	1	140	144
161760032007	32 x 3/4"	19	92	60	82	2	1	140	148
161760032010	32 x 1"	20	92	60	84	2	1	140	163
161760040005	40 x 1/2"	16	92	60	89	2	1	120	153
161760040007	40 x 3/4"	19	92	60	91	2	1	120	157
161760040010	40 x 1"	25	92	60	98	2	1	120	174
161760050005	50 x 1/2"	16	106	73	102	2	1	80	193
161760050007	50 x 3/4"	21	106	73	104	2	1	80	196
161760050010	50 x 1"	25	106	73	109	2	1	80	210
161760050013	50 x 1 1/4"	25	106	73	117	2	1	80	260
161760063005	63 x 1/2"	16	116	84	116	4	1	80	293
161760063007	63 x 3/4"	20	116	84	118	4	1	70	296
161760063010	63 x 1"	25	116	84	123	4	1	70	310
161760063013	63 x 1 1/4"	32	116	84	132	4	1	70	354
161760063015	63 x 1 1/2"	39	116	84	133	4	1	60	382
161760075005	75 x 1/2"	16	122	98	128	4	1	60	382
161760075007	75 x 3/4"	20	122	98	130	4	1	60	382
161760075010	75 x 1"	25	122	98	135	4	1	50	397
161760075013	75 x 1 1/4"	32	122	98	144	4	1	50	438
161760075015	75 x 1 1/2"	40	122	98	145	4	1	50	465
161760075020	75 x 2"	40	122	98	155	4	1	40	513
161760090005	90 x 1/2"	16	141	105	143	4	1	45	467
161760090007	90 x 3/4"	20	141	105	146	4	1	45	468
161760090010	90 x 1"	25	141	105	151	4	1	45	482
161760090013	90 x 1 1/4"	32	141	105	160	4	1	40	526
161760090015	90 x 1 1/2"	40	141	105	162	4	1	40	546
161760090020	90 x 2"	50	141	105	172	4	1	36	585
161760110005	110 x 1/2"	16	165	116	166	4	1	40	575
161760110007	110 x 3/4"	20	165	116	168	4	1	40	577
161760110010	110 x 1"	25	165	116	173	4	1	36	586
161760110013	110 x 1 1/4"	32	165	116	182	4	1	30	628
161760110015	110 x 1 1/2"	40	165	116	187	4	1	30	653
161760110020	110 x 2"	50	165	116	196	4	1	24	685
161760125007	125 x 3/4"	20	184	124	182	6	1	20	814
161760125010	125 x 1"	25	184	124	187	6	1	20	814
161760125013	125 x 1 1/4"	32	184	124	196	6	1	20	814
161760125015	125 x 1 1/2"	40	184	124	198	6	1	20	834
161760125020	125 x 2"	50	184	124	208	6	1	20	761
161760140010	140 x 1"	25	201	136	202	6	1	20	948
161760140013	140 x 1 1/4"	32	201	136	212	6	1	20	947
161760140015	140 x 1 1/2"	40	201	136	213	6	1	20	967
161760140020	140 x 2"	50	201	136	223	6	1	20	1001
161760160010	160 x 1"	25	223	145	223	6	1	16	1055
161760160013	160 x 1 1/4"	32	223	145	233	6	1	16	1098
161760160015	160 x 1 1/2"	40	223	145	235	6	1	16	1119
161760160020	160 x 2"	50	223	145	245	6	1	16	1137
161760180010	180 x 1"	25	245	154	243	6	1	16	1310
161760180013	180 x 1 1/4"	32	245	154	253	6	1	16	1335
161760180015	180 x 1 1/2"	40	245	154	255	6	1	16	1247
161760180020	180 x 2"	50	245	154	265	6	1	16	1368

* With coated steel bolts, Stainless steel bolts – optional

Plated Nut & Bolt for Saddles

16005*

Tornillo y tuerca de acero niquelado para collarin



Product Code	Bolts Dimensions/mm	Saddles
16005306	6 x 30	20 - 25
16005458	8 x 45	32 - 40 - 50 - 63
16005608	8 x 60	75 - 90 - 110
16005708	8 x 70	125 - 140 - 160 - 180

* Nuts & Bolts also available in stainless steel | * Tornillos y tuercas, a disposición, en acero inoxidable

Mechanical Tapping Valve

18680

Valvula mecanica con salida rotatoria tapper

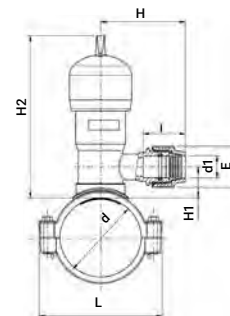

Product Code	Size d x d1	L	L1*	H	H1	H2	E	I	UB	UC	W
186800063032	63 x 32	116	55	135	240	55	64	67	—	8	2090
186800063063	63 x 63	116	60	200	240	60	113	110	—	8	2210
186800075032	75 x 32	122	60	135	244	60	64	67	—	8	1840
186800075063	75 x 63	122	65	200	244	65	113	110	—	8	2230
186800090032	90 x 32	141	60	135	244	60	64	67	—	8	2150
186800090063	90 x 63	141	65	200	244	65	113	110	—	8	2270
186800110032	110 x 32	165	60	135	244	60	64	67	—	8	2270
186800110063	110 x 63	165	65	200	244	65	113	110	—	8	2730
186800125032	125 x 32	184	60	135	244	60	64	67	—	8	2280
186800125063	125 x 63	184	65	200	244	65	113	110	—	8	2390
186800140032	140 x 32	201	60	135	244	60	64	67	—	8	2290
186800140063	140 x 63	201	65	200	244	65	113	110	—	6	2440
186800160032	160 x 32	223	60	135	244	60	64	67	—	6	2490
186800160063	160 x 63	223	65	200	244	65	113	110	—	6	2440
186800180032	180 x 32	245	60	135	244	60	64	67	—	6	2550
186800180063	180 x 63	245	65	200	244	65	113	110	—	4	2550

* L1 - Length along pipe | * L1 - longueur de la prise de branchement

* With stainless steel bolts and nuts

PLASSA)D)LE

PLASSON Mechanical Saddle



"PLASSADDLE" – PLASSON's revolutionary mechanical saddle

PLASSON is proud to introduce its newly designed mechanical saddle, featuring fast, bolt free installation as well as some of our well-established mechanical fitting features:

- Fast and Innovative tightening mechanism
- No bolts
- Non-corrosive, strong and durable plastic parts - no metal components
- Integral seals - no need for thread sealants

PLASSADDLE Threaded

16300

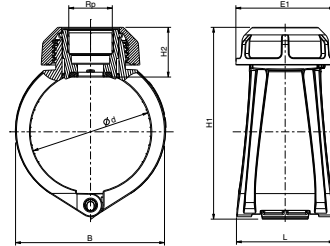

Product Code	Size d x Rp	B	L	E1	H1	H2	UB	UC	W
16300063005*	63 x 1/2"	91	89	102	136	49			
16300063007	63 x 3/4"	91	89	102	136	49			
16300063010	63 x 1"	91	89	102	136	49			
16300063013*	63 x 1 1/4"	91	89	102	146	58			
16300063015	63 x 1 1/2"	91	89	102	136	49			
16300090005*	90 x 1/2"	119	94	102	163	49			
16300090007	90 x 3/4"	119	94	102	163	49			
16300090010	90 x 1"	119	94	102	163	49			
16300090013*	90 x 1 1/4"	119	94	102	173	58			
16300090015	90 x 1 1/2"	119	94	102	163	49			
16300110005*	110 x 1/2"	141	97	102	180	49			
16300110007	110 x 3/4"	141	97	102	180	49			
16300110010	110 x 1"	141	97	102	180	49			
16300110013*	110 x 1 1/4"	141	97	102	190	58			
16300110015*	110 x 1 1/2"	141	97	102	180	49			
16300125005*	125 x 1/2"	157	100	102	198	49			
16300125007	125 x 3/4"	157	100	102	198	49			
16300125010	125 x 1"	157	100	102	198	49			
16300125013*	125 x 1 1/4"	157	100	102	207	58			
16300125015	125 x 1 1/2"	157	100	102	198	49			
16300160005*	160 x 1/2"	197	106	102	235	49			
16300160007	160 x 3/4"	197	106	102	235	49			
16300160010	160 x 1"	197	106	102	235	49			
16300160013*	160 x 1 1/4"	197	106	102	235	58			
16300160015	160 x 1 1/2"	197	106	102	235	49			
16300180005*	180 x 1/2"	220	110	102	255	49			
16300180007	180 x 3/4"	220	110	102	255	49			
16300180010	180 x 1"	220	110	102	255	49			
16300180013*	180 x 1 1/4"	220	110	102	264	58			
16300180015	180 x 1 1/2"	220	110	102	255	49			

PLASSADDLE Threaded

16310

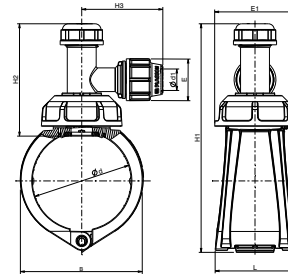

Product Code	Size d x d1	B	L	E	E1	H1	H2	H3	UC	W
1631060630250A	63 x 25	91	89	54	102	231	144	106	642	30
1631060630320A	63 x 32	91	89	64	102	231	144	111	677	30
1631060900250A	90 x 25	119	94	54	102	258	144	106		
1631060900320A	90 x 32	119	94	64	102	258	144	111	748	25
1631061100250A	110 x 25	141	97	54	102	273	144	106		
1631061100320A	110 x 32	141	97	64	102	273	144	111		
1631061220250A	122 x 25	157	100	54	102	290	144	106		
1631061220320A	122 x 32	157	100	64	102	290	144	111		
1631061250250A	125 x 25	157	100	54	102	290	144	106	820	24
1631061250320A	125 x 32	157	100	64	102	290	144	111	859	16
1631061600250A	160 x 25	198	106	54	102	325	144	106		
1631061600320A	160 x 32	198	106	64	102	325	144	111		
1631061770250A	177 x 25	220	110	54	102	350	144	106		
1631061770320A	177 x 32	220	110	64	102	350	144	111		
1631061800250A	180 x 25	220	110	54	102	350	144	106		
1631061800320A	180 x 32	220	110	64	102	350	144	111		

PLASSADDLE Tapper Male

1631R

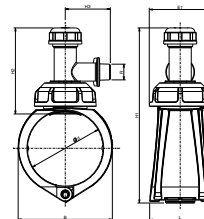

Product Code	Size d x d1	B	L	E1	H1	H2	H3	UC	W
1631R00630100A	63 x 1"	91	89	102	231	144	78		
1631R00900100A	90 x 1"	119	94	102	258	144	78		
1631R01100100A	110 x 1"	141	97	102	273	144	78		
1631R01220100A	122 x 1"	157	100	102	290	144	78		
1631R01250100A	125 x 1"	157	100	102	290	144	78		
1631R01600100A	160 x 1"	198	106	102	325	144	78		
1631R01770100A	177 x 1"	220	110	102	350	144	78		
1631R01800100A	180 x 1"	220	110	102	350	144	78		

Threaded Socket

050107*

Manguito rosca hembra x hembra

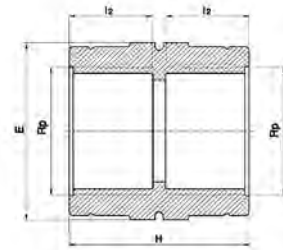

Product Code	Size Rp x Rp	H	I2	E	UB	UC	W
050107005	1/2" x 1/2"	39	17	30	10	1200	15
050107007	3/4" x 3/4"	41	19	36	10	1000	19
050107010	1" x 1"	45	21	46	10	600	31
050107013	1 1/4" x 1 1/4"	54	25	60	10	250	65
050107015	1 1/2" x 1 1/2"	54	25	65	10	250	76
050107020	2" x 2"	66	31	75	5	150	94

* With reinforcing ring - Cat. No. 050117 | * Con anillo de refuerzo - Cat. No. 050117

Threaded Socket with Reinforced Ring

050117

Manguito reductor rosca hembra-hembra con anillo de refuerzo

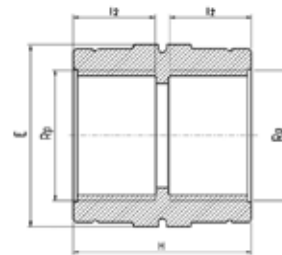

Product Code	Size Rp x Rp	H	I2	E	UB	UC	W
050117013	1 1/4" x 1 1/4"	54	25	60	10	250	89
050117015	1 1/2" x 1 1/2"	54	25	65	10	240	107
050117020	2" x 2"	65	30	75	5	150	127

Threaded Reducing Bushing

050207

Manguito reductor hembra x macho

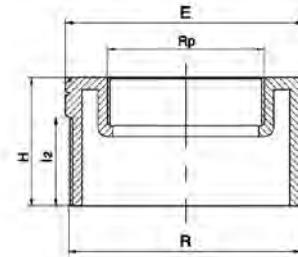

Product Code	Size Rp x Rp1	H	I2	E	UB	UC	W
050207007005	3/4" x 1/2"	30	17	27	10	2000	6
050207010005	1" x 1/2"	32	19	36	10	1000	16
050207010007	1" x 3/4"	32	19	36	10	1000	11
050207013005	1 1/4" x 1/2"	37	21	46	10	700	27
050207013007	1 1/4" x 3/4"	37	21	46	10	700	28
050207013010	1 1/4" x 1"	37	21	46	10	700	21
050207015005	1 1/2" x 1/2"	37	21	50	10	600	34
050207015007	1 1/2" x 3/4"	37	21	50	10	600	32
050207015010	1 1/2" x 1"	37	21	50	10	500	32
050207015013	1 1/2" x 1 1/4"	37	21	50	10	500	20
050207020005	2" x 1/2"	41	25	63	5	350	60
050207020007	2" x 3/4"	41	25	63	5	350	58
050207020010	2" x 1"	41	26	63	5	300	61
050207020013	2" x 1 1/4"	41	26	63	5	320	55
050207020015	2" x 1 1/2"	41	26	63	5	320	44
050207025020	2 1/2" x 2"	44	29	80	5	200	75
050207030010	3" x 1"	48	32	90	2	150	117
050207030013	3" x 1 1/4"	48	32	90	2	150	119
050207030015	3" x 1 1/2"	48	32	90	2	150	118
050207030020	3" x 2"	48	32	90	2	100	103
050207030025	3" x 2 1/2"	48	32	90	2	150	75
050207040020	4" x 2"	56	41	120	2	80	238
050207040030	4" x 3"	56	41	120	2	80	222

90° Threaded Tee

050407*

Te de 90° rosca hembra

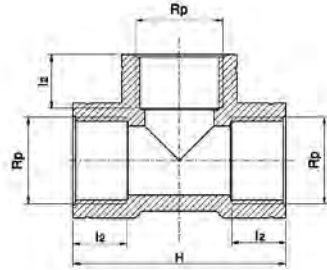

Product Code	Size Rp	H	I2	UB	UC	W
050407005	1/2"	64	18	10	700	28
050407007	3/4"	68	19	10	500	39
050407010	1"	81	21	10	260	61
050407013	1 1/4"	96	25	5	140	114
050407015	1 1/2"	108	25	5	90	157
050407020	2"	130	30	5	60	205

* With reinforcing ring - Cat. No. 050417 | * Con anillo de refuerzo - Cat. No. 050417

90° Threaded Elbow

050507*

Codo de 90° rosca hembra

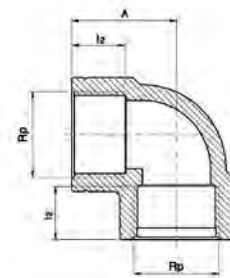

Product Code	Size Rp x Rp	A	I2	UB	UC	W
050507005	1/2" x 1/2"	32	17	10	1000	22
050507007	3/4" x 3/4"	35	18	10	700	30
050507010	1" x 1"	41	21	10	400	45
050507013	1 1/4" x 1 1/4"	48	25	10	200	87
050507015	1 1/2" x 1 1/2"	54	25	5	150	116
050507020	2" x 2"	65	30	5	80	157

* With reinforcing ring - Cat. No. 050517 | * Con anillo de refuerzo - Cat. No. 050517

90° Threaded Elbow with Reinforced Ring

050517

Codo 90° de rosca hembra con anillo de refuerzo

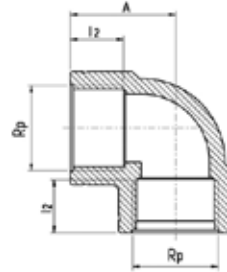

Product Code	Size Rp x Rp	A	I2	UB	UC	W
050517013	1 1/4" x 1 1/4"	48	25	10	200	111
050517015	1 1/2" x 1 1/2"	54	25	5	140	147
050517020	2" x 2"	65	30	5	80	190

90° Threaded Elbow Male x Female

051507

Codo roscado-macho x hembra

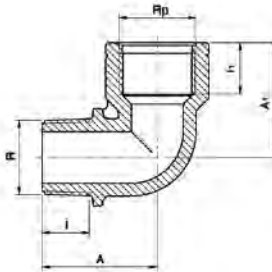

Product Code	Size R x Rp	A	A1	I	I1	UB	UC	W
051507005	1/2" x 1/2"	36	36	16	17	10	1000	17
051507007	3/4" x 3/4"	40	40	17	18	10	700	25
051507010	1" x 1"	45	47	19	21	10	400	40

Threaded Riser

051607

Espiga roscada

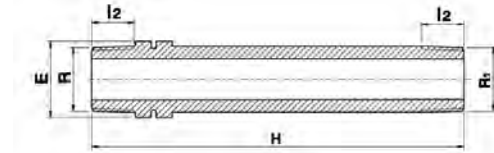

Product Code	Size R x R	H	I2	E	UB	UC	W
051607005	1/2" x 1/2"	150	17	22	10	600	30
051607007005	3/4" x 1/2"	113	18	27	10	500	26
051607007	3/4" x 3/4"	150	18	27	10	400	43
051607010	1" x 1"	150	19	36	5	250	65
051607013	1 1/4" x 1 1/4"	150	21	46	5	150	93
051607015013	1 1/2" x 1 1/4"	150	21	50	5	140	120
051607015	1 1/2" x 1 1/2"	150	21	50	5	140	120

Threaded Plug

051707

Tapón rosca macho

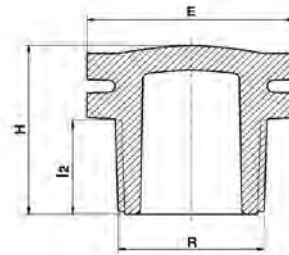

Product Code	Size R	H	I2	E	UB	UC	W
051707003	3/8"	24	13	22	10	4500	4
051707005	1/2"	29	16	27	10	2000	8
051707007	3/4"	31	17	32	10	1500	12
051707010	1"	34	19	36	10	1000	16
051707013	1 1/4"	38	21	46	10	700	26
051707015	1 1/2"	39	21	55	10	500	38
051707020	2"	45	25	65	10	300	60

Threaded Reducing Nipple

050605

Machón doble reductor

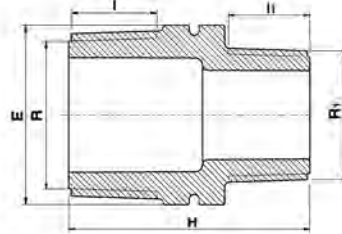

Product Code	Size R x R	A	A1	I	I1	UB	UC	W
050605007005	3/4" x 1/2"	47	17	17	16	10	1500	10
050605010005	1" x 1/2"	49	19	19	16	10	800	17
050605010007	1" x 3/4"	50	19	19	17	10	800	18
050605013005	1 1/4" x 1/2"	53	21	21	16	10	500	28
050605013007	1 1/4" x 3/4"	54	21	21	17	10	500	29
050605013010	1 1/4" x 1"	56	21	21	19	10	500	31
050605015005	1 1/2" x 1/2"	54	21	21	16	5	500	34
050605015007	1 1/2" x 3/4"	55	21	21	17	5	500	34
050605015010	1 1/2" x 1"	57	21	21	19	5	400	36
050605015013	1 1/2" x 1 1/4"	59	21	21	21	5	400	39
050605020005	2" x 1/2"	58	25	25	16	5	280	51
050605020007	2" x 3/4"	59	25	25	17	5	260	52
050605020010	2" x 1"	61	25	25	19	5	260	53
050605020013	2" x 1 1/4"	63	25	25	21	5	240	57
050605020015	2" x 1 1/2"	63	25	25	21	5	240	58

Threaded Nipple

050607

Machón doble

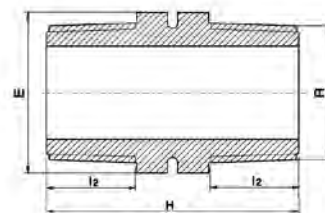

Product Code	Size R x R	H	I2	E	UB	UC	W
050607005	1/2" x 1/2"	47	17	22	10	1800	8
050607007	3/4" x 3/4"	49	18	27	10	1500	11
050607010	1" x 1"	55	20	36	10	800	23
050607013	1 1/4" x 1 1/4"	60	22	46	10	400	35
050607015	1 1/2" x 1 1/2"	61	22	50	5	300	48
050607020	2" x 2"	71	26	65	5	180	78

Threaded Cap

050707

Machón doble

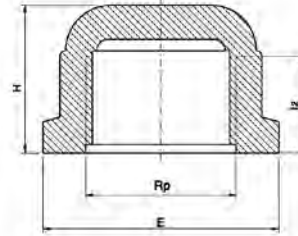

Product Code	Size Rp	E	H	I2	UB	UC	W
050707005	1/2"	37	25	15	10	1600	13
050707007	3/4"	42	26	16	10	1500	14
050707010	1"	50	32	19	10	800	27
050707013	1 1/4"	59	34	22	10	500	39
050707015	1 1/2"	65	34	21	10	450	43
050707020	2"	80	39	25	5	250	78

Threaded Reducing Socket

051107

Manguito reductor rosca hembra - hembra

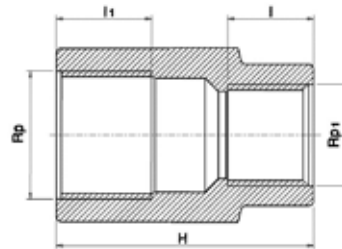

Product Code	Size Rp x Rp1	H	I	I1	E	UB	UC	W
051107007005	3/4" x 1/2"	50	20	19	36	10	800	24

Ball Valve

03703

Válvula esférica



Product Code	Size DN x Rc	E	H	I	B	A1	A2	UB	UC	W
0370300005	15 x 1/2"	53	97	17.5	36	27	54	—	72	180
0370300007	20 x 3/4"	53	97	17.5	36	27	54	—	72	175
0370300010	25 x 1"	64	116	20.5	46	33	64	—	72	313
0370300013	32 x 1 1/4"	73	118	20	55	36	70	—	48	393
0370300015**	40 x 1 1/2"	91	144	24	65	41	87	—	30	712
0370300020**	50 x 2"	106	162	29	75	53	95	—	24	918

* 037030F - with drain port | * 037030F – con sistema de purga

** Long handle

New ball valves can be found in page 216

PA Ball Valve Female x Male

NEW!

0370302

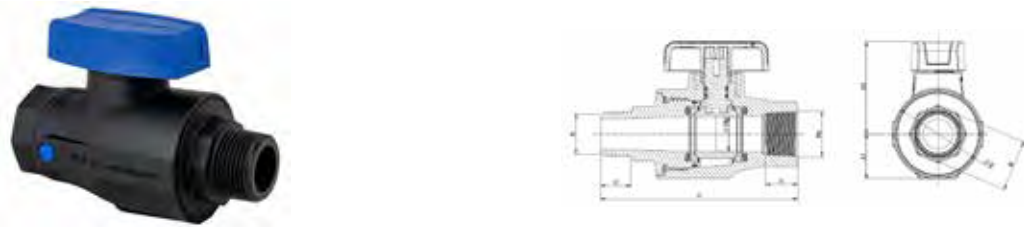

Product Code	Size Rc x R	Rp	DN	A1	A2	H	I1	I2	B	E	UC	W
03703020S00005	1/2" x 1/2"	1/8"	20	27	54	114	18	17	27	53		
03703020S00007	3/4" x 3/4"	1/8"	20	27	54	117	19	18	30	53		
03703020S00010	1" x 1"	1/8"	25	33	64	133	22	21	41	64		

* 03703020SF - with drain port | * 03703020SF – con sistema de purga

Threaded Stoptap (Seal NBR)

03405

Válvula de línea rosca hembra (juntas NBR)

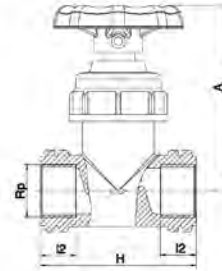

Product Code	Size Rp x Rp	H	I2	A	UB	UC	W
03405077	3/4" x 3/4"	78	18	95	5	140	115
03405110	1" x 1"	82	20	95	5	120	129

Compression Stoptap (Seal NBR)

03406

Válvula de línea compresión (juntas NBR)

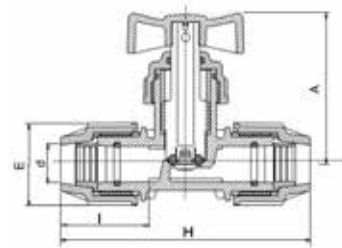

Product Code	Size d x d	E	H	I	A	UB	UC	W
03406020	20 x 20	48	147	58	101	5	100	171
03406025	25 x 25	54	157	60	91	5	80	190
03406032	32 x 32	64	163	70	95	5	60	264

Angle Seat Valve (Seal NBR) Threaded x Compression 03048/03948

Válvula de asiento angular - compresión - rosca macho - juntas NBR

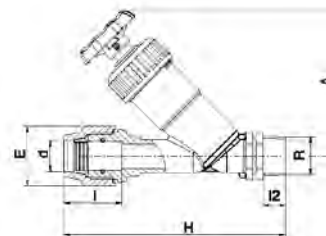

Product Code	Size d x R	E	H	I	I2	A	UB	UC	W
030482050	20 x 1/2"	48	174	57	16	113	—	100	176
030482570A	25 x 3/4"	54	187	60	18	121	—	80	238
030483210A	32 x 1"	64	212	70	20	140	—	50	360
039484080	40 x 1 1/4"	82	299	84	22	180	—	26	600
039485050	50 x 1 1/2"	96	259	93	22	207	—	17	925
039486320	63 x 2"	113	340	110	26	246	—	10	1518

Angle Seat Valve (Seal NBR) Threaded Inlet & Outlet

03047*

Válvula de asiento angular, (sello NBR) roscas macho

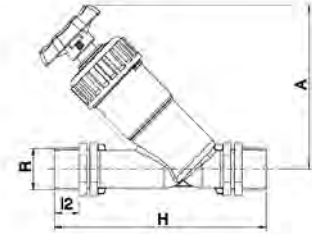

Product Code	Size R x R	H	I2	A	UB	UC	W
03047055	1/2" x 1/2"	135	16	113	5	120	142
03047077	3/4" x 3/4"	151	18	121	5	100	186
03047110	1" x 1"	170	20	140	—	70	291
03047188	1 1/4" x 1 1/4"	225	22	207	—	40	474
03047155	1 1/2" x 1 1/2"	200	22	180	—	24	733
03047220	2" x 2"	254	26	246	—	15	1191

* Available with NPT thread | * Disponible con rosca NPT

Angle Seat Valve (Seal FPM) Threaded Inlet & Outlet

03049*

Válvula de asiento angular, (sello FPM) roscas macho

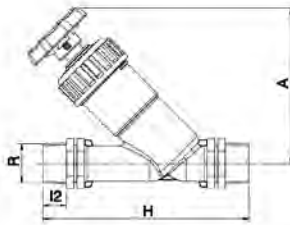

Product Code	Size R x R	H	I2	A	UB	UC	W
03049055	1/2" x 1/2"	135	16	113	5	120	136
03049077	3/4" x 3/4"	151	18	121	5	100	191
03049110	1" x 1"	170	20	140	—	70	295
03049188	1 1/4" x 1 1/4"	200	22	180	—	40	474
03049155	1 1/2" x 1 1/2"	225	22	207	—	24	733
03049220	2" x 2"	254	26	246	—	15	1207

* Available with NPT thread | * Disponible con rosca NPT

Angle Seat Valve (Seal NBR) Compression Inlet & Outlet

03046

Válvula de asiento angular, (sello NBR) compresión

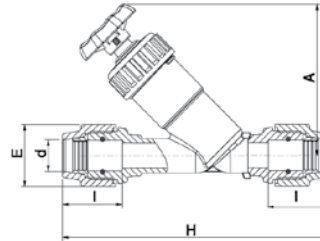

Product Code	Size d x d	E	H	I	A	UB	UC	W
03046323	32 x 32	64	254	70	140	—	40	438

Check Valve (Seal EPDM) Threaded Inlet & Outlet

03067*

Válvula antirretorno, (sello EPDM) roscas macho

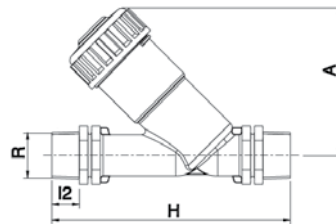

Product Code	Size R x R	H	I2	A	UB	UC	W
03067077	3/4" x 3/4"	151	18	96	5	140	141
03067110	1" x 1"	170	20	106	5	100	210
03067188	1 1/4" x 1 1/4"	200	22	134	—	55	382
03067155	1 1/2" x 1 1/2"	225	22	155	—	35	586
03067220	2" x 2"	254	26	182	—	20	975

* Available with NPT thread | * Disponible con rosca NPT

Fix Ratio Pressure Reducing Valve

03801

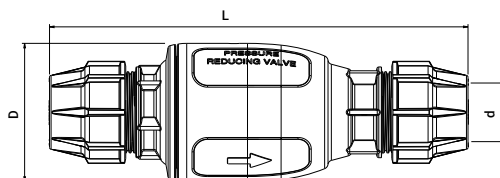

Product Code	pressure reducing ratio	Size d	D	L	UB	UC	W
03801200630A	2:1	63	150	450	—	6	3040
03801300630A	3:1	63	150	450	—	6	2780
03801201100A	2:1	110	260	770	—	1	17700

Universal Pressure Regulator UPR 550

0220

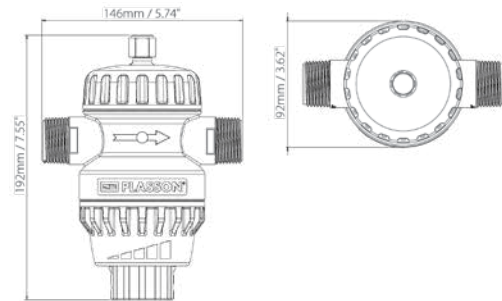

Product Code	Inlet/Outlet	Inlet Pressure	Outlet Pressure	UB	UC	W
02206500	1" BSPT	0.5-16 bar	0.5-4.0 bar	—	30	700
02205950	1" NPT	0.5-16 bar	0.5-4.0 bar	—	30	700

Quick Coupling Valve (Seal NBR)

03039

Válvula de acople rápido (juntas NBR)

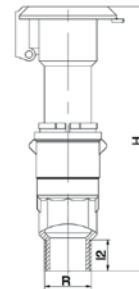

Product Code	Size R	H	I2	UB	UC	W
03039037	3/4"	152	17	5	130	146
03039030	1"	154	18	5	130	148

Key for Quick Coupling Valve 3039

03139

Conexión de acople rápido

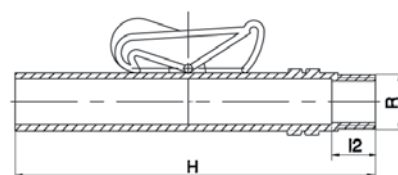

Product Code	Size R	H	I2	UB	UC	W
03139020	3/4"	173	18	5	250	66

Check Valve Insert

03226/03227

Válvula de antirretorno

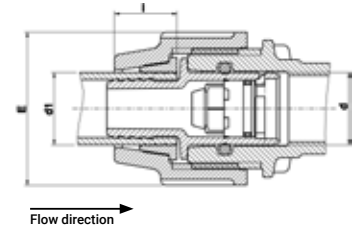
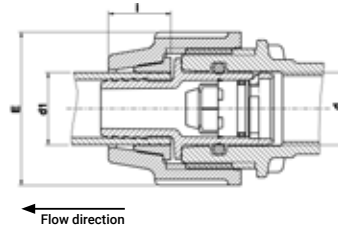

Product Code	Size d x d1	E	I	UB	UC	W
03226025	25 x 25	63	22	–	800	15

BSPT Record for Water Meter

3589

Tubo y tuerca BSPT

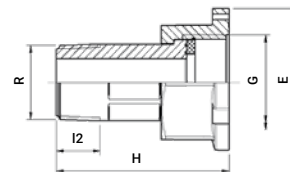

Product Code	Size G x R	E	H	I2	UB	UC	W
0358906005	3/4" x 1/2"	40	56	16	2	150	37
0358906007	1" x 3/4"	48	61	16	2	150	53

Water Meter Seat

03510T

Soporte para control de flujo de agua

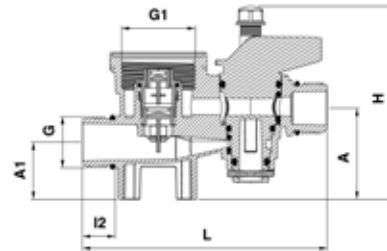

Product Code	Size G x G1 x G	L	I2	A	A1	H	UC	W
03510TT010010	1"x1½"x1"	160	21	59	37	130	60	270

Water Meter Manifold

03510

Soporte para control de flujo de agua

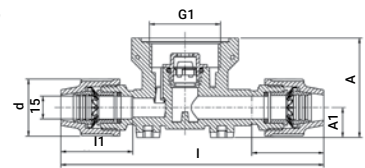
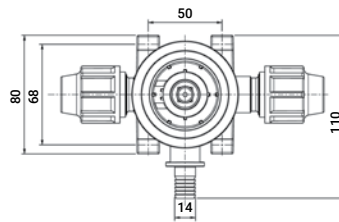

Product Code	Size d x G1 x d	I	I1	A	A1	UB	UC	W
03510000	15 x 1 1/2" x 15	178	49	67	20	—	100	100

PP Ball Valve - Compression X Compression

036010

PP Válvula de esfera

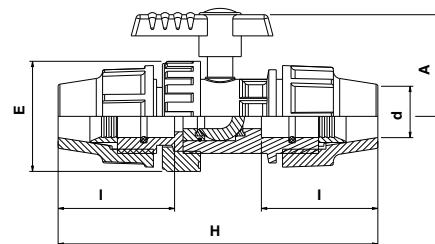

Product Code	Size d	E	H	I	A	UB	UC	W
036010020	20	52	151	55	48	—	—	150
036010025	25	60	160	55	60	—	—	200
036010032	32	78	186	62	70	—	—	350

PP Ball Valve - Compression X Male Threaded

036020

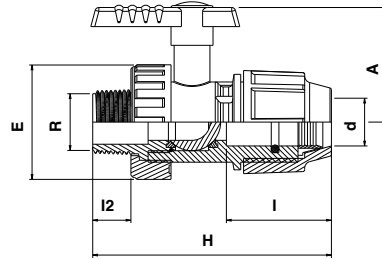

Product Code	Size d x R	E	H	I	I2	A	UB	UC	W
036020020005	20 x 1/2"	52	113	55	17	48	—	—	120
036020025007	25 x 3/4"	60	123	55	18	60	—	—	160
036020032010	25 x 1"	60	125	62	20	60	—	—	167
036020025010	32 x 1"	78	144	62	20	70	—	—	280

PP Ball Valve - Compression X Female Threaded

036030

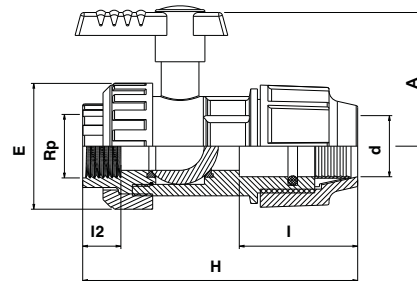

Product Code	Size d x Rp	E	H	I	I2	A	UB	UC	W
036030020005	20 x 1/2"	52	113	55	17	48	—	—	120
036030025007	25 x 3/4"	60	123	55	18	60	—	—	160
036030032010	32 x 1"	78	144	62	20	70	—	—	280
036030032013	32 x 1 1/4"	78	144	62	23	70	—	—	280

Quarter Turn Valve Male Threaded x Compression

03010

Rosca Macho/Compresión

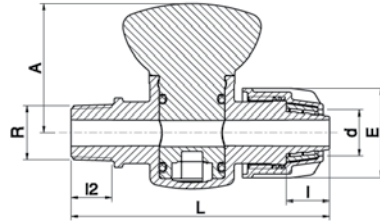

Product Code	Size d x R	H	A	E	I	I1	UB	UC	W
03010516	16 x 1/2"	98	49	34	17	15	10	450	68
03010716	16 x 3/4"	99	49	34	17	17	10	400	72

Quarter Turn Valve Male Threaded x Female Threaded

03012

Rosca Macho-/Rosca Hembra

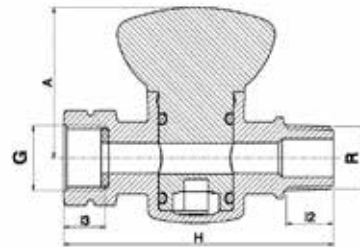

Product Code	Size Rp x R	H	A	I1	I2	UB	UC	W
03012055	1/2" x 1/2"	89	49	15	14	10	450	46
03012077	3/4" x 3/4"	97	49	17	18	10	400	73

Quarter Turn Valve Compression x Compression

03017

Compresión

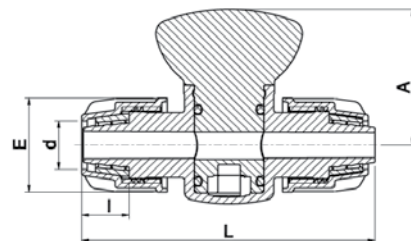

Product Code	Size d x d	L	A	E	I	UB	UC	W
03017016	16 x 16	105	49	34	17	10	350	70

Technical Specifications and Installation Instructions

Technical Specifications

Materials

Compression Fittings

Body: Polypropylene, high-grade copolymer.
 Nut: Polypropylene, high-grade copolymer.
 Split Ring: Acetal POM (CPVC also available).
 Liner: Acetal (POM).
 Seal: Nitrile rubber NBR (EPDM, FPM also available).
 Reinforcing ring: Stainless steel on all female offtakes from 1¼" up to 4".
 Bolts (160mm fittings): Plated steel.
 Nuts (160mm fittings): Stainless steel.

Valves

Body: Polypropylene, high-grade copolymer.
 O-Ring: See inside.
 Spring: (items 03067, 03039), Stainless steel.

Saddles

Body: Polypropylene, high-grade copolymer.
 Bolts and Nuts: Plated steel.
 (Stainless steel bolts and nuts also available)
 Reinforcing Rings: Stainless steel.
 Seal: Nitrile rubber (NBR).

Tappers + Body: Polypropylene, high-grade copolymer.
 Split Rings: Acetal (POM, CPVC also available).
 Bolts and Nuts: Stainless Steel.
 Seal: EPDM.

Threaded Fittings

Body: Polypropylene, high-grade copolymer.
 Reinforcing Ring: Stainless Steel.

Operating Temperatures

The fittings and valves are not to be used with hot water, although they withstand the same temperature as the polyethylene pipe itself. The fittings and valves will withstand sub-zero temperatures.

Chemical Resistance

PLASSON Fittings are supplied, as standard, with polyacetal split rings and NBR O-rings which are suitable for water. For aggressive chemical applications CPVC split rings and EPDM or FPM O-rings can be supplied to produce a better chemical resistance.

Operating Pressures and Quality Certificates

PLASSON Fittings are tested and approved according to ISO 17885 (replaced ISO 14236), water and AS/NZ 4129. For detailed pressure classification see page 76.

Threads

All threads conform to ISO-7/1 (BSPT), BS 21 - 1973, DIN 2999, NEN 3258, AS 1722 Part 1 - 1975.

All internal (female) threads smaller than 3" are parallel (Rp). All other threads (male and female) are tapered (R).

Flanges

Flange dimensions in accordance with: ISO 7005-1 (TABLE 11), BS 4504: 1989 (TABLE 11), DIN 2501 (PN 16 TABLE), AS/NZS 4331. Metal backing rings to be used with all flanges.

Legend	
UB	Units par bag
UC	Units per carton
W	Weight in grams

Note

Before installation ensure that the end of the pipe to be inserted into the fitting is free of scratches and other imperfections and that both the pipe and the fitting itself are clean of sand, mud, stones etc.

Do not over tighten nut when closing. Never use wrenches or spanners with handle lengths longer than 46 cm - excessive torque during tightening can spread nut cone and result in pull outs.

If fittings are reused, ensure split ring is sharp and bites into pipe to avoid pull outs. Alternatively replace split ring.

Pull out resistance of Series 7 fittings combined with the UPVC/PP grip ring has been approved by pressure testing UPVC/PP pipe assemblies at 25 bar operating pressure for at least 1 hour.

Note: We strongly recommend the use of PTFE tape in threaded connections.

Especificaciones Técnicas

Materiales

Accesorios de compresión

Cuerpo: Polipropileno, block copolímero de alta calidad.
 Racor: Polipropileno, block copolímero de alta calidad.
 Casquillo de apriete: Acetal (POM).
 Disponibles también en PVC-C.
 Refuerzo interno de tubos: Acetal (POM).
 Junta tórica: Nitrilo (NBR).
 disponibles también en EPDM y FPM
 Anillo de refuerzo: Acero inoxidable en todas las
 tomas roscadas hembra de 1¼" a 4".
 Tornillos (Series 17): Acero niquelado.
 Tuercas: Acero inoxidable.

Válvulas

Cuerpo: Polipropileno, block copolímero de alta calidad.
 Junta tórica: Ver catálogo.
 Resorte: (03067, 03039), Acero inoxidable.

Collarines

Cuerpo: Polipropileno, block copolímero de alta calidad.
 Tornillos y tuercas: Acero niquelado.
 (También se dispone de tornillos y tuercas de acero
 inoxidable)
 Anillo de refuerzo: Acero inoxidable.
 Juntas: NBR.

Tapper y Collarín de compresión

Cuerpo: Polipropileno, block copolímero de alta calidad.
 Casquillo de apriete: Acetal (POM).
 disponibles también en PVC -C
 Racor: Polipropileno, block copolímero de alta calidad.
 Tornillos y tuercas: Acero inoxidable.
 Juntas: EPDM.

Accesorios roscados

Cuerpo: Polipropileno, block copolímero de alta calidad.
 Anillo de refuerzo: Acero inoxidable.

Temperaturas de Trabajo

Los accesorios y las válvulas no son recomendados para
 usar con agua caliente, aunque soportan las mismas
 temperaturas que las propias tuberías de polietileno.
 Sin embargo pueden resistir temperaturas inferiores a los
 cero grados centígrados.

Resistencia a las Sustancias Químicas

Los accesorios PLASSON están provistos, como estándar,
 con Casquillos de Apriete de resina acetálica y Juntas tóricas
 de NBR, recomendados para usar con agua potable. Para las
 aplicaciones de productos químicos agresivos se ofrecen
 Casquillos de Apriete de CPVC y Juntas tóricas de EPDM
 o FPM, que resisten mejor a las sustancias químicas.

Presiones de Funcionamiento y Certificados de Calidad

Todos los accesorios de PLASSON se someten a pruebas de
 aprobación, de conformidad con las normativas ISO 17885
 – Agua (Reemplaza a la ISO 14236) y AS/NZ 4129. Para
 ver una clasificación detallada de las presiones, consulte la
 página 79.

Roscas

Todas las roscas responden a las normas ISO-7/1 (BSPT),
 BS 21 - 1973, DIN 2999, NEN 3258, AS 1722 Part 1 - 1975.

Solo las roscas hembra menores a 3" no son cónicas (RP).
 Todas las otras roscas macho y hembra son cónicas (R).

Bridas

Las dimensiones de las bridas responden a las normas
 ISO 7005-1 (TABLE 11),
 BS 4504: 1989 (TABLE 11),
 DIN 2501 (PN 16 TABLE), AS/NZS 4331.
 Con todas las bridas debe ser utilizado como refuerzo una
 brida de metal.

Legend

UB	Unidades por bolsa
UC	Unidades por carton
W	Peso en gramos

Nota

Antes de la instalación asegure que:
 El extremo del tubo introducido no tenga imperfecciones o
 rayaduras Tanto el tubo como el accesorio no tenga sobre
 los mismos arena, barro o piedras, etc. No cierre el racor con
 extremada fuerza, nunca use llaves con manijas mas largas
 de 46 cm. Un excesivo momento de torsion durante el cierre
 puede dañar el cono del racor y como resultado del mismo
 no permitir su propio funcionamiento Si los accesorios son
 usados nuevamente despues de su desarmado, constate que
 los dientes del casquillo de apriete permanecen afilados y se
 hincan en el tubo impidiendo el escape del tubo. Si no es asi,
 cambie el casquillo de apriete.

La resistencia a tracción de accesorios de Serie 7 que
 combinan el uso de casquillo de apriete para tubos de UPVC
 / PP ha sido aprobada por medio de pruebas de presión para
 tubos UPVC / PP con una presión de operación de 25 bar
 durante al menos 1 hora.

Nota: Recomendamos utilizar cinta de PTFE para sellar todas
 las conecciones roscadas.

Technical Specifications

Pressure Rating of PLASSON Mechanical Fittings and Valves

Product Code	Body Type	Pressure Rating	Stainless Steel Reinforcement Ring	From Pipe Diameter	To Pipe Diameter	From Thread	To Thread	From Outlet Size	To Outlet Size
line 7/87 compression fittings									
Starts with 07 and 87	All Fitting Types	16.0							
Exceptions:									
Starts with 07	All 160 mm Fittings	10.0							
Starts with 07 and 87	All Fittings with 3 inch Female Thread	10.0							
Starts with 07 and 87	All Fittings with 4 inch Female Thread	6.0							
0701070/ 0705070	Plass 4 (Universal)	10.0		50	50			35	50
0704P	90° Slip Tee	12.5		40	63				
07120	Plug Adaptor	12.5		20	63				
07220	Compression Flange Adaptor	12.5		125	125				
07250	Threaded Adaptor	12.5		75	75	1 1/2	3		
07640	45° Tee	8.0		63	110				
87930	Reducing Set 110X63	10.0							
Valves									
03046/03047/03048/03049	Angle Seat Valve	8.0							
03405	Threaded Stoptap	10.0				3/4	1		
03407	Compression Stoptap	16.0		20	32				
03039	Quick Coupling Valve	10.0				3/4	1		
03067	Check Valve	8.0							
03703	PA ball valve	16.0							
0360	PP ball valve	10.0							
line 5 threaded fittings									
Starts with 05	All fittings	16.0							
Exceptions									
0501/0504/0505	socket /elbow /Tee without reinforcement ring	10.0	NO			1 1/4	2		
050207/ 050707	Threaded Reducing Bushing/Threaded Cap	10.0				1 1/4	2		
Saddles									
160760	Saddle Single Outlet	12.5	YES	20	63	1/2	1 1/2		
160760	Saddle Single Outlet	12.5	YES	75	180	1/2	3/4		
160760	Saddle Single Outlet	10.0	YES	75	180	1	2		
160761	Saddle Single Outlet	16.0	YES	40	180	1	1		
160860	Saddle Single Outlet	6.0	NO	20	180	1 1/4	2		
160860	Saddle Single Outlet	10.0	NO	20	180	1/2	1		
161760	Saddle Double Outlet	12.5	YES	20	63	1/2	1 1/2		
161760	Saddle Double Outlet	12.5	YES	75	180	1/2	3/4		
161760	Saddle Double Outlet	10.0	YES	75	180	1	2		
161860	Saddle Double Outlet	6.0	NO	20	180	1 1/4	2		
161860	Saddle Double Outlet	10.0	NO	20	180	1/2	1		
16279	Saddle Single Outlet	16.0	YES	63	180	1 1/2	1 1/2		
16310/16300/1631R	PLASSADDLE	16.0							
Silver line compression fittings									
starts with 14	All fittings	10.0							
Series 1 compression fittings									
starts with 10	All fittings	16.0							

Especificaciones Técnicas

Presiones Nominales (PN) de Accesorios y Válvulas Mecánicas / Compresión de PLASSON

Código de producto	Tipo	Presión Nominal	Anillo de Refuerzo de Acero Inoxidable	From Pipe Diameter	To Pipe Diameter	From Thread	To Thread	From Outlet Size	To Outlet Size
Accesorios de Compresión Serie 7 / 87									
Starts with 07 and 87	All Fitting Types	16.0							
Excepciones:									
Starts with 07	All 160 mm Fittings	10.0							
Starts with 07 and 87	All Fittings with 3 inch Female Thread	10.0							
Starts with 07 and 87	All Fittings with 4 inch Female Thread	6.0							
0701070/ 0705070	Plass 4 (Universal)	10.0		50	50			35	50
0704P	90° Slip Tee	12.5		40	63				
07120	Plug Adaptor	12.5		20	63				
07220	Compression Flange Adaptor	12.5		125	125				
07250	Threaded Adaptor	12.5		75	75	1 1/2	3		
07640	45° Tee	8.0		63	110				
87930	Reducing Set 110X63	10.0							
Válvulas									
03046/03047/03048/03049	Angle Seat Valve	8.0							
03405	Threaded Stoptap	10.0				3/4	1		
03407	Compression Stoptap	16.0		20	32				
03039	Quick Coupling Valve	10.0				3/4	1		
03067	Check Valve	8.0							
03703	PA ball valve	16.0							
0360	PP ball valve	10.0							
Accesorios Roscados Línea 5									
Starts with 05	All fittings	16.0							
Excepciones									
0501/0504/0505	socket /elbow /Tee without reinforcement ring	10.0	NO			1 1/4	2		
050207/ 050707	Threaded Reducing Bushing/Threaded Cap	10.0				1 1/4	2		
Collarines/ Arranques/ Tomas simples									
160760	Saddle Single Outlet	12.5	YES	20	63	1/2	1 1/2		
160760	Saddle Single Outlet	12.5	YES	75	180	1/2	3/4		
160760	Saddle Single Outlet	10.0	YES	75	180	1	2		
160761	Saddle Single Outlet	16.0	YES	40	180	1	1		
160860	Saddle Single Outlet	6.0	NO	20	180	1 1/4	2		
160860	Saddle Single Outlet	10.0	NO	20	180	1/2	1		
161760	Saddle Double Outlet	12.5	YES	20	63	1/2	1 1/2		
161760	Saddle Double Outlet	12.5	YES	75	180	1/2	3/4		
161760	Saddle Double Outlet	10.0	YES	75	180	1	2		
161860	Saddle Double Outlet	6.0	NO	20	180	1 1/4	2		
161860	Saddle Double Outlet	10.0	NO	20	180	1/2	1		
16279	Saddle Single Outlet	16.0	YES	63	180	1 1/2	1 1/2		
16540	All Tappers - for PVC & PE Pipes	16.0							
Línea Silver – Accesorios de Compresión									
starts with 14	All fittings	10.0							
Serie 1 – Accesorios de Compresión									
starts with 10	All fittings	16.0							

Installation Instructions for Compression Fittings

ASSEMBLY AS SIMPLE AS ABC...

For Fittings 16mm - 63mm / Para accesorios de 16mm - 63mm

Cut the pipe square, remove burrs • Undo the nut to the last thread. Leave the nut on the fitting while inserting the pipe.

Corte el tubo al tamaño requerido y realice el biselado al final del tubo • Retire el racor hasta su última rosca dejándolo en el accesorio durante el próximo paso.



Twist the pipe into the fitting* through the split ring and rubber seal to the pipe stop • Tighten the nut firmly. Use a PLASSON wrench (or similar tool) for final tightening of sizes 40 and above.

Introduzca el tubo con un movimiento circular dentro del accesorio pasando el casquillo de apriete y el sello hasta llegar al tope interno del accesorio • Gire firmemente el racor en dirección del cuerpo del accesorio, utilizando la llave PLASSON (o similar) en los tamaños 40mm y mayores.

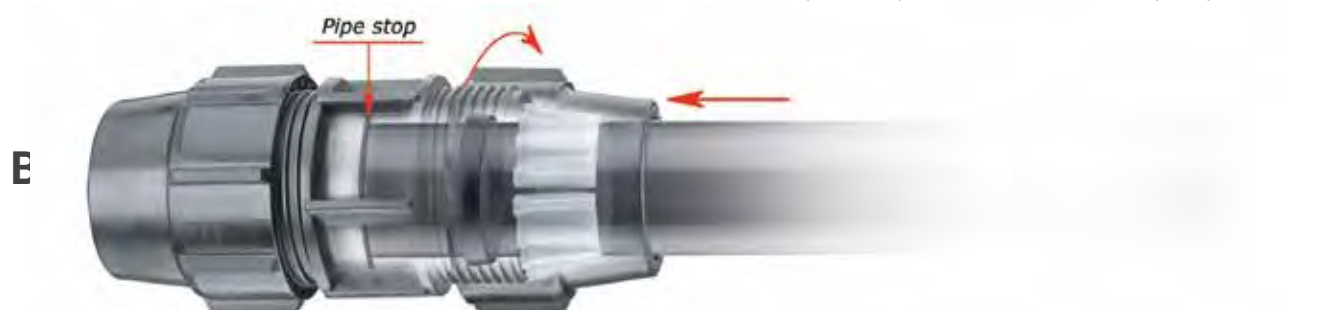

The nut should be closed tightly, however there is no need for the nut to actually meet the body shoulder.

Cierre el racor firmemente, aunque no es necesario cerrarlo hasta el tope.



* Lubrication and chamfering of the pipe end will ease insertion of the pipe (use silicone lubricant).

* A fin de facilitar la introducción es conveniente lubricar y biselar el tubo (con un lubricante que conforma las normas de aprobación de calidad del agua).

Installation Instructions for Compression Fittings

Assembly Instructions For Fittings Sizes 75mm - 125mm

1 Cut the pipe, square. Remove the nut and split ring. Reposition nut, bush and o-ring on pipe 2 diameters back. Lubricate pipe and o-ring.



2 Push the pipe fully into the fitting body until stopped by the internal stop. Push the o-ring and plastic bush forward against the fitting. They will not enter the body of the fitting.



3 Tighten nut to push the bush and o-ring right into the fitting until the bush is flush with fitting mouth.



4 Fully unscrew nut and pull back along pipe.



5 Open split ring and place on pipe with lugs touching bush. Reuse split rings only twice, blunt rings will not bite into pipe.



6 Firmly tighten with PLASSON C spanner. Overtightening can cause blow outs.



Do not use a wrench with handle lengths longer than standard PLASSON C spanners. For 63mm: max. handle length should be 22cms. For 75–125mm: max. handle length should be 46cms.

Instrucciones de instalación para Accesorios de Compresión

Instrucciones de instalación para accesorios de diámetros 75mm - 125mm

- 1** Corte el tubo, perpendicularmente. Retire el racor, el casquillo de apriete, el inserto de PP y la junta tórica. Coloque el racor, el inserto de PP y junta tórica en la tubería a una distancia de aproximadamente el doble del diámetro del tubo. Lubricar tubería y junta tórica.

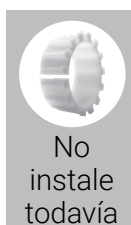

- 2** Empuje el tubo introduciéndolo completamente en el cuerpo del accesorio hasta llegar al tope interno del accesorio. Empuje la junta tórica y el inserto de PP hacia delante contra el accesorio. Manualmente, estos elementos no entrarán en el cuerpo.

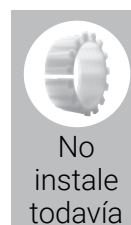

- 3** Apriete el racord para empujar el inserto de PP y la junta tórica para conseguir que éstos entren en el interior del accesorio hasta que lleguen al tope.

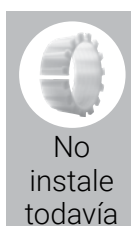

- 4** Desenrosque completamente el racor y retirarlo hacia atrás a lo largo de la tubería.

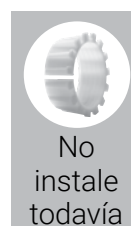

- 5** Abra el casquillo de apriete y colóquelo en la tubería con la parte más ancha tocando el inserto de PP. Reutilice el casquillo de apriete un máximo de dos veces.



- 6** Apriete firmemente con la llave PLASSON. El apriete excesivo puede causar el gripado de la rosca.



Recomendamos utilizar la Llave PLASSON. No use llaves de apriete con longitudes mayores a las recomendadas. Para 63 mm: la longitud máxima debe ser de 22 cm. Para 75-125 mm: la longitud máxima tiene que ser de 46 cm.

Installation Instructions for Pipe Adaptors Conversion Sets

Universal Pipe Adaptors: Copper, Galvanised and Imperial U-PVC (Without Pullout Resistance)

Juegos de conversión de tubería: galvanizada, de cobre o de UPVC medidas imperiales (sin resistencia a la tracción)



Prepare pipe by ensuring that the end is free from grease and roughen the outer surface with wire wool or similar. Cut pipe end square. Remove nut from end of fitting and discard white split ring.



Push adaptor into fitting to the stop. Push and twist the pipe until it meets the internal stop.



Screw nut tightly towards the body of the fitting. Final tightening with a wrench is essential. The installation should be firmly anchored against end loading.

Se prepara el tubo asegurándose que el final del tubo no tenga grasa, y se lija el exterior con lana de alambre. Se hace un corte perpendicular al final del tubo. Se lleva el racor al final del accesorio y se quita el casquillo de apriete blanco.

Se empuja el adaptador en el tubo hasta el tope se empuja y se enrosca el tubo hasta que llegue al tope interior del accesorio.

Se aprieta firmemente el racor hacia el interior del accesorio. Es imprescindible que se apriete con una llave. Después, anclar firmemente la instalación.

Installation Instructions for Pipe Adaptors Conversion Sets

Adaptor Set for Copper (With Pullout Resistance) Juego de adaptadores para cobre (con resistencia a traccion)



Cut pipe square. Remove burrs. Ensure pipe is free of scratches, dents and other imperfections. Remove nut from fitting and discard white split ring. Make a mark on the pipe to the depth of the rubber insert. Assemble nut, brown ring and stainless steel ring onto pipe in that order. Ensure the brown ring tapers towards the nut and the stainless steel ring towards the fitting body.

Push insert into fitting body fully up to the flange.

Push pipe end into body of fitting. Ensure to insert at least to the mark you have made. Push both the rings up to the insert flange and engage nut. Use a PLASSON wrench for final tightening.

Corte el tubo a escuadra, limpie los restos del corte. Asegure que el tubo no este rayado, dentado, con virutas o con otras imperfecciones. Se lleva el racor hasta el final del accesorio y se quita el casquillo de apriete blanco. Se hace una marca en la superficie del tubo que es la profundidad del adaptador de goma. Se colocan el racor, el anillo marrón y el anillo de acero en el tubo, en este orden. Se comprueba que el anillo marrón se remata hacia la tuerca y el anillo de acero hacia el interior del accesorio.

Introducir el adaptador en el interior del accesorio hasta el final

Introducir el tubo en el interior del accesorio. Comprobar que se introduce por lo menos hasta la marca hecha previamente. Se empujan ambos anillos hasta el adaptador de goma y se cierra firmemente el racor. Para apretar firmemente se debe utilizar la llave PLASSON.

Installation Instructions for Pipe Adaptors Conversion Sets

Lead Pipe Adaptor Adaptadores para tuberías de plomo



Remove nut from fitting and discard white split ring. Mount nut on pipe followed by brown split ring and seal ring.



Push both components onto the pipe until the seal ring is 20mm from the end of pipe and touching the split ring.



Enter pipe into fitting body and tighten firmly with a wrench. (It is important that the pipe is not pushed fully to the stop in the fitting).

Note for lead pipe adaptors: This product seals on the outside diameter of the pipe and it is therefore important that the lead pipe is in good condition on the external part of the pipe where the seal is made. Variation in the lead piping sometimes results in oversized pipes. In these circumstances it may be preferable to use the white split ring provided with the fitting.

Se lleva el racor al final del accesorio y se quita el casquillo de apriete blanco. Se monta el racor al tubo seguido por el casquillo marrón y el anillo de goma.

Se empujan los dos componentes hasta que el anillo de goma esté a 20mm del final del tubo, y tocando el casquillo de apriete marrón.

Se introduce el tubo en el interior del accesorio y se aprieta firmemente con una llave (es importante que no se empuje el racor completamente hasta el final del accesorio).

Nota: El sellado con este producto se realiza con el diámetro exterior del tubo, y por lo tanto es importante que el exterior de la tubería de plomo esté en buen estado. Las variaciones en la tubería de plomo resultan a veces demasiado grandes. En estas circunstancias es preferible usar el casquillo de apriete que está previsto con el accesorio.

Installation Instructions for Plass4 and Copper Pipe Adaptor (Universal Adaptor)



Installation Instructions for PLASS4 (Universal) Fittings Instrucciones para la instalacion de accesorios plass4

Cut the pipe square and remove all burrs and sharp edges.

Select correct fitting according to the external diameter of the pipe.

Slide the PLASS4 fitting (universal side) onto the pipe, until it reaches the internal fins and a slight resistance is felt.

Do not force the pipe end past the fins.

Holding the PLASS4 body with a wrench, tighten the PLASS4 universal nut firmly with a wrench (size 35-50 tighten nut very firmly to approx. 90 NM)

Assemble the metric PE joint as per the standard fitting instructions.

Note: If reusing the fitting, ensure the metal teeth are located in the grip ring and pipe end does not pass the location fins in the body.

Corte el tubo a escuadra y elimine todas las virutas y cantos vivos.

Elija el accesorio apropiado de acuerdo con el diámetro del tubo.

Introduzca el accesorio PLASS4 (del lado Universal) en el tubo hasta que llegue al tope s sienta una ligera resistencia.

No fuerce el tubo y no pase las aletas.

Agarrando el cuerpo del PLASS4 con una llave apropiada, cierre firmamente el raccor con una llave (en las medidas 35-50 su raccor puede ser cerrado con un momento de 90 Nm). Arme la union de PE como en las instrucciones de los accesorios normales.

IMPORTANTE: no fuerce el tubo y pase el punto de resistencia. Puede danar el el accesorio.

Comience apretar la tuerca al cuerpo. el cierre final hagalo con una llave PLASSON o similar. Ensamble la junta metrica como las instrucciones de un accesorio estandard.

Installation Instructions for Plass4 and Copper Pipe Adaptor (Universal Adaptor)



Installation Instructions for Copper Pipe Adaptor Instrucciones para la instalacion de adaptor tubo de cobre

Cut the copper pipe square and remove all burrs and sharp edges.
Twist the copper pipe into the fitting* through the rubber o-ring to the pipe stop.
Tighten the nut firmly. Use a wrench for final tightening. The nut should be closed tightly, however there is no need for the nut to actually meet the body shoulder.
Assemble the metric PE joint as per the standard fitting instructions.
* Lubrication of the pipe end will ease the insertion (use silicone lubricant).
Note: If reused, the metal grip ring must be replaced with a new one.

Corte el tubo a escuadra y elimine todas las virutas y cantos vivos.
Introduzca girando* el tubo de cobre junto con el o-ring hasta el tope.
Apriete la tuerca firmemente. use una llave para el apriete final. La tuerca debe estar apretada herméticamente. Sin embargo no es necesario que llegue hasta el borde del cuerpo.
Ensamble la junta metrica pe como un accesorio estandard.
* Para facilitar la introduccion utilice un lubricante a base de silicona.

NOTA: Si quiere reusar el accesorio debe reemplazar el agarre de metal por uno nuevo.



The logo consists of a red square containing a white stylized 'P' symbol, followed by the word 'PLASSON' in white, uppercase, sans-serif font.

PLASSON

ELECTROFUSION FITTINGS



Introduction Introducción

Electrofusion System	98	Sistema ElectroFusión	99
Table of Contents	100-104	Indice	100-104
Fittings	105-151	Accesorios	105-151
Wastewater Line	152-157	Aguas residuales	152-157
Technical Specifications	158	Especificaciones técnicas	159

PLASSON, a worldwide leader in fittings for polyethylene pipes for over 50 years, now offers a complete line of electrofusion products including: PLASSON electrofusion fittings, tools and control boxes.

PLASSON electrofusion products combine to offer a reliable smart-system solution featuring fully computerized control and monitoring.

PLASSON's customers benefit from the Company's quality products, expertise and worldwide first-rate service in water, gas distribution, Waste-Water Systems, Geothermal applications and industrial applications.

PLASSON, líder mundial en accesorios para tuberías de polietileno desde hace más de 50 años, presenta ahora una línea completa de productos de electrofusión, entre ellos: conectores, herramientas y soldadoras automáticas de electroFusión. La combinación de productos electrofusion de PLASSON ofrece una solución inteligente y confiable que integra el control y la monitorización completamente computarizados.

Los clientes de PLASSON se benefician de los productos de calidad, la pericia y el excelente servicio mundial de la compañía en instalaciones de distribución de agua y gas, y aplicaciones industriales.

Subsidiary Companies Subsidiarias

Australia

PLASSON Australia (PTY) Ltd.
E-mail: info@plasson.com.au
www.plasson.com.au

Brasil

PLASSON Do Brasil
E-mail: plasson@plasson.com.br
www.plasson.com.br

France

PLASSON France S.A.
E-mail: commercial@plassonfrance.fr
www.plasson.fr

Germany

PLASSON GmbH
E-mail: info@plasson.de
www.plasson.de

Italy

PLASSON Italia
E-mail: info@plasson.it
www.plasson.it

Poland

PLASSON Polska Sp.z o.o.
E-mail: bs@plasson.pl
www.plasson.pl

South Africa

PLASSON SA Pty Ltd, t/a PPA
E-mail: support@ppa.co.za
www.ppa.co.za

Spain

PLASSON Spain S.L.
E-mail: plasson@plasson.es
www.plasson.es

United Kingdom

PLASSON UK Ltd.
E-mail: miron@plasson.co.uk
www.plasson.co.uk

USA

PLASSON USA
E-mail: sales@plassonusa.com
www.plassonusa.com

Romania

PLASSON Romania (BSR)
E-mail: contact@bsr.ro
www.plasson.ro

PLASSON Electrofusion System

The Smart-System Solution You Can Depend On

PLASSON Electrofusion Fittings

PLASSON fittings are specifically designed for reliable, high performance pipe joining and long system life. This automated system has been proven to be most economical due to the low potential for operator error.

Tools and Control Box

PLASSON offers quality tools and control boxes allowing for easy installation. PLASSON control boxes provide computerized electrofusion with minimal potential for operator error. The PLASSON control boxes are the economical solution for reliable electrofusion.

The Smart Fuse System - PLASSON Electrofusion

All PLASSON products combine to form the latest state-of-the-art high performance pipe joining solution. PLASSON electrofusion fittings are part of a complete electrofusion Smart Fuse System. The entire electrofusion process is executed and fully monitored by the computerized control box. Everything is computer-controlled ensuring safe, dependable connections.

PLASSON electrofusion fittings can be used with PLASSON's computerized Smart Fuse System control box or with standard barcode systems. Each PLASSON electrofusion fitting comes complete with a barcode.

Advantages

Stronger pipe joining - PLASSON electrofusion quality fittings have long penetration depths and fusion zones which ensure high quality joints.

Most Economical - Economic benefits are a result of overall integrated system quality and innovation including the computerized Smart Fuse System which reduces the potential for operator error.

PLASSON Electrofusion Smart Fuse System Features

- **Superior Fitting Design**
increases joint integrity
- **Automatic Controller**
decreases potential operator error
- **Computerized Data Retrieval**
ensures quality control by Joint Data retrieval of measurements and records
- **Compatibility**
between PLASSON electrofusion and other electrofusion systems through the computerized barcode system
- **Easy Installation**
using PLASSON's simple, practical tools
- **High Standards**
are ensured by the latest product testing methods

High Performance - Proven high performance in gas and water distribution and industrial applications.

Superior Service - PLASSON provides unmatched service based on over 40 years in the field.

Sistema Electrofusion de PLASSON

La solución inteligente de confianza

Accesorios Electrofusion de PLASSON

Los accesorios ("fittings") de PLASSON para tuberías han sido especialmente diseñados para asegurar conexiones fiables, de alto rendimiento y prolongada vida útil. Se ha comprobado que este sistema automatizado es el más económico, gracias a la escasa probabilidad de errores por parte del operador.

Herramientas y soldadora automática de ElectroFusión

PLASSON ofrece herramientas de alta calidad y soldadoras automáticas que se instalan fácilmente. Las soldadoras, que proporcionan un proceso computarizado con mínima probabilidad de error humano, son la solución más económica para una electrofusión de máxima confianza.

Electrofusion de PLASSON - El sistema inteligente

Los productos de PLASSON se combinan para ofrecer la solución más avanzada y rendidora en la conexión de tuberías. Los accesorios electrofusion de PLASSON forman parte de un sistema completo e inteligente. La soldadora automática de ElectroFusión está a cargo de la ejecución y la monitorización del proceso. El sistema controlado por computadora asegura conexiones seguras y confiables.

Ventajas

Uniones más resistentes - Los accesorios de alta calidad electrofusion de PLASSON tienen grandes profundidades de penetración y zonas de fusión que aseguran juntas muy resistentes.

La solución más económica - El beneficio económico es el resultado de la calidad y la innovación del sistema computarizado totalmente integrado, que reduce la probabilidad de error humano.

Características del sistema inteligente Electrofusion de PLASSON

- **Excelente diseño**
asegura la integridad de la conexión
- **Control automático**
reduce la probabilidad de error humano
- **Recuperación de datos**
calidad asegurada mediante la recuperación de datos de mediciones y registros
- **Compatibilidad**
con el sistema electrofusion de PLASSON y otros sistemas de códigos de barras
- **Instalación sencilla**
mediante las herramientas prácticas y simples de PLASSON
- **Estándar elevado**
asegurado por los métodos de prueba de productos de última generación

Alta performance - Elevado rendimiento comprobado en instalaciones de distribución de gas y agua, y aplicaciones industriales.

Excelente servicio - PLASSON le brinda un servicio inigualado, con su pericia y experiencia de más de 40 años en el terreno.

Fittings

490104/490103

Page 105 | Coupler
Enlace Recto



4901L4

Page 106 | Long Coupler
Enlace Largo



450104

Page 106 | Coupler (PN 25)
Enlace Recto (PN 25)



460104/460103

Page 108 | LightFit Coupler (PN 10)
Enlace LightFit (PN 10)



4601S3

Page 109 | Super LightFit (PN 6.4)



491104

Page 109 | Reducing Coupler
Enlace Reductor



491107

Page 110 | Spigot Reducer
Reductor Espiga



49009

Page 111 | Flex Restraint



494204

Page 112 | Monolithic End Cap
Tapón Monolítico



491204

Page 112 | End Cap
Tapón



491207

Page 113 | Spigot End Plug
Tapón Espiga



490404

Page 115 | Tee 90°
Enlace T 90°



492404

Page 115 | Two Outlets Reducing Tee
Enlace te Reductor con Salida Doble



491404

Page 116 | Reducing Tee
Enlace T Reductor



499404

Page 117 | Flanged Tee
Enlace T Bridado



490504

Page 117 | Elbow 90°
Codo 90°



490604

Page 118 | Elbow 45°
Codo 45°



490804

Page 118 | Elbow 22.5°
Codo 22.5°



46060

Page 119 | LightFit Elbow 45°
Codo LightFit 45°



46330

Page 119 | LightFit Elbow 30°
Codo LightFit 30°



46370

Page 119 | LightFit Elbow 15°
Codo LightFit 15°



490904

Page 120 | Elbow 180°
Codo 180°



491904

Page 120 | Y Reducer
Y Reductor



491504

Page 121 | Duckfoot Elbow 90°
Codo 90° Empotrable



4915Q4

Page 121 | Duckfoot Elbow 90° with Outlet
Codo 90° Empotrable con
Toma de Servicio



4947C4

Page 122 | Adjustable Elbow
Codo Ajustable



4947D4

Page 122 | Adjustable Elbow One Sided
Codo Ajustable Enlace/
Espiga



496804

Page 123 | Balloon Saddle
Collarín Globo



498304

Page 123 | Monolithic Weld End Cap for
Ballon Saddle
Tapón Monolítico Soldable
para Collarín Globo



4958T4

Page 124 | Saddle Female Rp
Threaded Outlet



495204

Page 124 | Repair Saddle
Toma de Reparación



493804

Page 125 | Transition Saddle
Collarín de Transición



493803

Page 128 | Sensor Adaptor with Brass
Thread



4938S3

Page 128 | Sensor Adaptor with a
Stainless Steel thread



495804

Page 129 | Branch Saddle
Collarín de Derivación



495804

Page 130 | Branch Saddle
Collarín de Derivación



4958X4

Page 130

Branch Saddle



495803

Page 132-133

XL&XXL Branch Saddle
XL&XXL Collarín de Derivación



4758W

Page 133

LightFit Branch Saddle
Collarín de Derivación LightFit



495904

Page 134

Flange Branch Saddle
Collarín bridado



4959X4

Page 135

Flanged Branch Saddles
DN100
Collarín Bridado DN 100



495204

Page 135

Repair Saddle
Collarín de reparación



496304

Page 136-137

Tapping Saddle
Toma de Servicio



4963P4

Page 138

Tapping Saddle Parallel Outlet
Toma de Servicio Salida Parallel
Outlet



491304

Page 139

High Volume Tapping Tee
(HVTT)



498304

Page 139

Welding Cap for Tapping Saddle
Tapón Soldable para toma de
Servicio



436207

Page 140

PE Ball Valve
Válvula de Bola PE



436Q7

Page 140

PE Ball Valve with
Two Purges
PE Ball Válvula de
Bola con purga



495404/4954S4

Page 141

Tapping Valve
Toma de Servicio con
Válvula



492104

Page 142

Male Transition Coupler
Enlace de Transición Macho



493104

Page 142

Female Transition Coupler
Enlace de Transición
Hembra



492504

Page 143

Male Transition Elbow 90°
Codo de Transición de 90°
Macho



493504

Page 144

Female Transition Elbow 90°
Codo de Transición de 90°
Hembra



492604

Page 144

Male Transition Elbow 45°
Codo de Transición de 45°
Macho



493604

Page 145

Female Transition Elbow 45°
Codo de Transición de 45°
Hembra



494104

Page 145

Female Free Nut
Transition Coupler
Enlace de Transición,
Tuerca Libre, Hembra



494504

Page 146

Female Free Nut
Transition Elbow 90°
Codo de Transición de 90°
Tuerca Libre, Hembra



494604

Page 146

Female Free Nut Transition
Elbow 45°
Codo de Transición de 45°
Tuerca Libre, Hembra



494404

Page 147

Female Union Free Nut
Transition Tee
Enlace T, PE/Latón, Tuerca
Libre, Hembra



497104

Page 147

PE Male Transition Coupler
Enlace de Transición PE
Macho



497504

Page 148

PE Male Transition Elbow 90°
Codo de Transición PE de 90°
Macho



497604

Page 148

PE Male Transition Elbow 45°
Codo de Transición PE de 45°
Macho



497704

Page 149

PE Cast Iron Flange
Transition Coupler
Enlace de Transición
Bridado - PE Hierro Fundido



495704

Page 149

PE Cast Iron Spigot
Transition Coupler
Enlace de Transición Espiga
- PE Hierro Fundido



490209

Page 150

Full Face Flange
Brida de Cara Plana



490207

Page 150

Stub Flange
Adaptador de Brida



09903

Page 151

Flange Backing Ring
Brida Revestida



Wastewater Line

475804

Page 153

Wastewater Adjustable
Saddle
Ramal para Aguas
Residuales



4758A4

Page 153

Wastewater Saddle 45° -
Inlet 110
Ramal 45° de Salida para
Aguas Residuales



4758V4

Page 154

Wastewater Saddle PVC/PP
Adaptor Inlet
Collarin Lightfit de transición para
Aguas Residuales de PE A PP/PVC



4758S4

Page 154

Wastewater Saddle Spigot
Inlet
Titulo



4747D4

Page 155

Wastewater Adjustable
Elbow One Sided
Codo Ajustable para Aguas
Residuales Enlace/Espiga



37020/477207

Page 155

Wastewater Manhole
Adaptor
Adaptador para Pozo de
Aguas Residuales



4701V4

Page 156

Wastewater PE to PVC
Adaptor
Adaptador Para PE A PVC



4747V4

Page 156

Wastewater Adjustable
Elbow PE to PVC
Codo Ajustable de
Transición de PE a PVC



470604

Page 157

Wastewater Elbow 45°
Codo 45° Para Aguas
Residuales



473304

Page 157

Wastewater Elbow 30°
Codo 30° Para Aguas
Residuales



473704

Page 157

Wastewater Elbow 15°
Codo 15° Para Aguas
Residuales



Coupler

490104

Enlace Recto



20mm up to 75mm

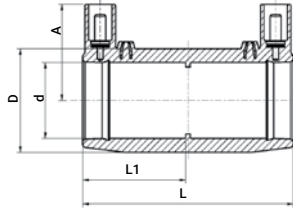

90mm up to 355mm

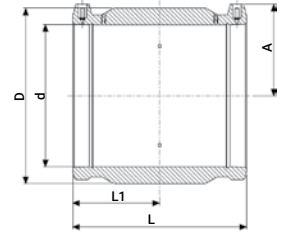

Product Code	Size d	L	L1	D	A	UC	W
490104016	16	71	34	35	39	480	58
490104020	20	76	37	31	34	440	50
490104025	25	82	40	36	37	360	40
490104032	32	88	42	44	42	256	64
490104040	40	97	47	56	46	200	97
490104050	50	101	49	67	51	125	160
490104063	63	118	58	82	56	72	230
490104075	75	126	61	98	64	60	340
490104090	90	148	73	112	71	38	475
490104110	110	163	80	135	81	23	718
490104125	125	173	85	157	87	18	1075
490104140	140	183	90	174	97	12	1295
490104160N	160	195	93	194	105	6	1555
490104180N	180	212	105	218	116	5	2112
490104200N	200	223	109	242	126	4	2785
490104225N	225	240	119	272	138	4	3900
490104250	250	251	123	301	156	2	4461
490104280	280	275	134	342	170	1	6440
490104315	315	282	139	387	184	1	8845
490104355	355	277	137	431	203	1	10200
490103400	400	293	145	485	231	1	13800

490103

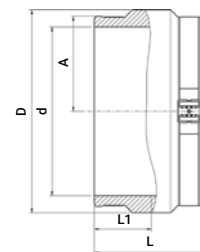

Product Code	Size d	L	L1	D	A	UC*	W
490103450	450	306	153	539	257	1	16000
490103500	500	340	170	603	283	1	20200
490103560	560	376	188	674	317	1	28000
490103630N	630	418	209	759	356	1	41100
490103710	710	472	236	853	400	1	62000
490103800	800	500	250	955	450	1	87000
490103900	900	500	250	1070	503	1	100100
4901031000	1000	570	285	1194	563	1	

* Due to product size, cannot be packed in standard carton | * Cantidad óptima para embalaje en dos pallets apilados

Long Coupler

4901L4

Enlace Largo

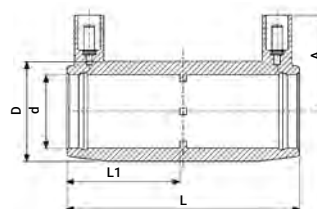

Product Code	Size d	L	L1	D	A	UC	W
4901L4032	32	104	50	44	43	272	83
4901L4040	40	121	59	56	46	128	135
4901L4050	50	139	68	68	51	96	215
4901L4063	63	166	81	82	57	48	318

Coupler (PN 25)

450104

Enlace Recto (PN 25)

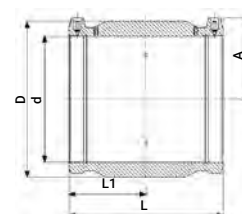
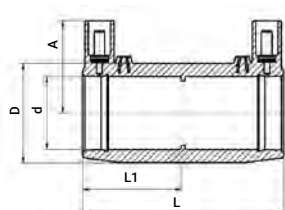

Product Code	Size d	L	L1	D	A	UC	W
450104050	50	100	49	68	52	125	147
450104063	63	118	57	82	58	72	230
450104075	75	126	62	97	65	60	339
450104090	90	148	73	117	69	38	571
450104110	110	163	80	140	79	23	835
450104125	125	173	85	157	87	18	1075
450104140	140	105	175	181	89	12	1320
450104160	160	198	97	198	105	6	1780
450104180	180	212	104	224	114	4	2449
450104200	200	223	110	249	126	4	3295
450104225	225	240	118	280	140	4	4366
450104250	250	256	127	310	155	2	5507
450104280	280	274	135	341	166	1	6369
450104315	315	284	140	381	184	1	8884
450103355	355	280	138	430	204	1	10438



PLASSON Excess Flow Valve

The Excess Flow Valve (EFV), also called Gas Stop, is a special safety valve intended to be used in the house connection line of natural or other gas systems. It is typically installed at the outlet of the tapping saddle at the branch off point or on the house connection line, but can be installed at other locations and applications as well.

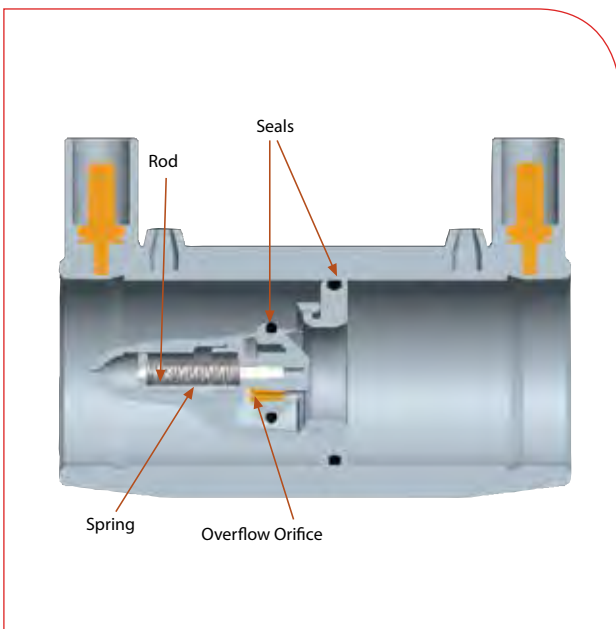
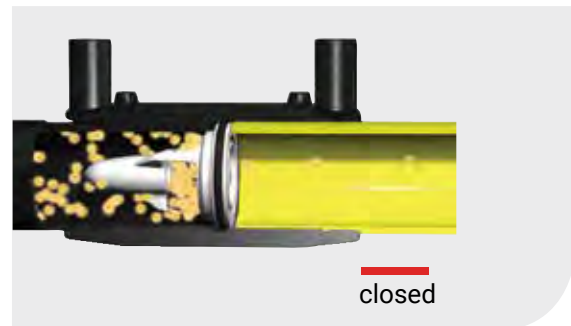

Design Features:

- Fully mechanical
- Unique design results in very low head loss at operation flow
- Easy installation

Components and Materials:

- Plastic Parts – PolyAcetal (POM-thermoplastic polymer)
- Rod – Stainless Steel or Brass (depending on model)
- Overflow Orifice - Brass
- Spring – Stainless Steel
- Seals – NBR

Application

- In PE Gas Conducting Systems

LightFit Coupler (PN10)

460104

Enlace LightFit (PN10)

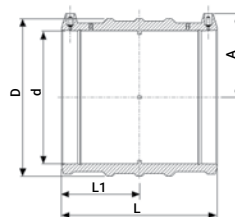

Product Code	Size d	L	L1	D	A	UC	W
460104040	40	90	43	56	47	200	96
460104050	50	100	49	68	52	132	147
460104063	63	118	57	77	57	112	158
460104075	75	126	61	90	63	60	216
460104090	90	148	72	108	69	44	360
460104110	110	163	80	131	79	25	540
460104125	125	173	85	149	87	20	760
460104140	140	182	89	167	94	12	970
460104160	160	198	97	193	104	6	1320
460104180	180	212	104	215	114	5	1650
460104200	200	232	114	235	127	4	2110
460104225	225	240	118	264	141	4	2825
460104250	250	256	126	293	155	2	3728
460104280	280	275	135	332	166	1	4850
460104315	315	284	140	374	184	1	6950
460104355	355	280	138	421	204	1	7980
460104400	400	296	146	474	227	1	12000

460103*

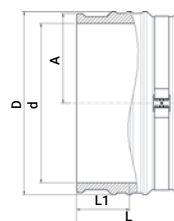

Product Code	Size d	L	L1	D	A	UC*	W
460103450N	450 **	310	155	518	255	1	11700
460103500	500**	340	170	576	283	1	16000
460103560N	560	376	188	625	309	1	21510
460103630N	630	400	200	706	347	1	27000
460103710N	710	440	220	797	390	1	43100
460103800N	800	470	235	897	440	1	57300
460103900	900	500	250	1010	500	1	70000
4601031000	1000	600	300	1128	555	1	-
4601031200	1200	600	300	1355	667	1	-

* Due to product size, cannot be packed in standard carton | * Cantidad óptima para embalaje en dos pallets apilados

** Without Straps | ** Sin correas

Super LightFit (PN 6.4)

4601S3

Super LightFit (PN 6.4)

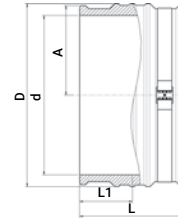

Product Code	Size d	L	L1	D	A	UC*	W
4601S3500	500	300	150	550	272	1	11800
4601S3560	560	310	155	620	310	1	15300
4601S3630	630	320	160	693	346	1	18200
4601S3710	710	380	190	775	388	1	25800
4601S3800	800	400	200	876	438	1	34700
4601S3900	900	420	210	983	485	1	40500
4601S31000	1000	440	220	1085	534	1	48000

* Due to product size, cannot be packed in standard carton | * Cantidad óptima para embalaje en dos pallets apilados.

Reducing Coupler

491104

Enlace Reductor

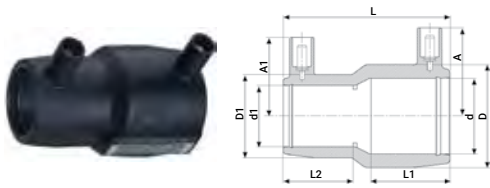

20x16mm up to 110x90mm

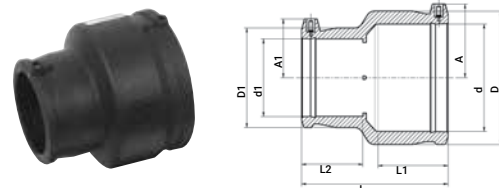

125x90mm up to 180x125mm

Product Code	Size dxd1	L	A	A1	L1	L2	D	D1	UC	W
491104020016	20 x 16	71	39	39	35	35	36	36	480	54
491104025016	25 x 16	71	38	38	35	35	36	36	480	49
491104025020	25 x 20	71	39	39	35	35	36	36	480	46
491104032016	32 x 16	80	42	34	39	35	44	32	360	58
491104032020	32 x 20	81	43	37	40	35	45	32	360	59
491104032025	32 x 25	81	43	39	40	35	45	36	360	56
491104040020	40 x 20	90	44	38	44	40	56	36	360	58
491104040025	40 x 25	90	47	38	44	40	56	37	200	86
491104040032	40 x 32	90	47	43	44	40	56	44	160	92
491104050025	50 x 25	100	52	41	49	41	68	37	160	118
491104050032	50 x 32	100	52	45	49	40	68	45	128	123
491104050040	50 x 40	100	52	48	49	44	68	56	128	135
491104063032	63 x 32	119	59	45	57	40	82	45	96	180
491104063040	63 x 40	119	59	49	57	44	82	56	96	192
491104063050	63 x 50	119	59	54	57	49	82	68	80	224
491104075063	75 x 63	126	66	59	66	57	98	82	65	314
491104090050	90 x 50	143	78	53	71	49	116	69	54	430
491104090063	90 x 63	143	78	61	71	57	116	82	44	460
491104090075	90 x 75	143	78	67	71	61	116	98	41	480
491104110063	110 x 63	161	84	61	78	57	139	82	32	639
491104110075	110 x 75	159	83	66	80	62	140	98	-	-
491104110090	110 x 90	161	84	74	78	72	139	116	23	740
491104125090	125 x 90	171	88	70	85	72	158	116	18	1019
491104125110	125 x 110	171	88	80	85	78	158	141	18	1025
491104160090	160 x 90	193	105	69	94	72	199	116	12	1440
491104160110	160 x 110	193	105	80	94	81	199	141	12	1520
491104160125	160 x 125	195	105	89	94	85	199	158	6	1570
491104180125	180 x 125	212	116	87	103	85	222	158	6	2060

Spigot Reducer

491107

Reductor Espiga

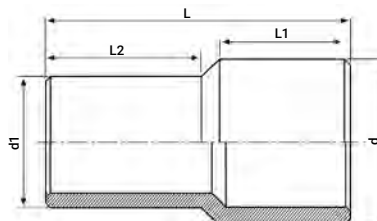

Product Code	Size dxd1	L	L1	L2	UC	W
491107032025	32 x 25	104	50	48	240	30
491107040032	40 x 32	123	59	56	240	90
491107050032	50 x 32	129	59	56	160	100
491107050040	50 x 40	131	59	60	264	80
491107063032	63 x 32	131	59	58	144	110
491107063040	63 x 40	132	59	58	144	120
491107063050	63 x 50	132	60	60	128	125
491107075040	75 x 40	145	71	60	96	167
491107075050	75 x 50	145	71	59	96	180
491107075063	75 x 63	151	71	65	72	210
491107090050	90 x 50	156	81	59	56	280
491107090063	90 x 63	160	80	65	48	300
491107090075	90 x 75	166	80	71	40	320
491107110063	110 x 63	167	83	66	36	450
491107110075	110 x 75	169	83	72	36	460
491107110090	110 x 90	178	83	80	28	510
491107125090	125 x 90	186	90	81	24	655
491107125110	125 x 110	188	90	84	18	730
491107140090	140 x 90	208	95	80	16	850
491107140110	140 x 110	195	95	83	16	850
491107140125	140 x 125	199	95	89	12	950
491107160110	160 x 110	219	101	84	10	1,360
491107160125	160 x 125	206	101	88	16	1170
491107160140	160 x 140	211	101	94	10	1270
491107180125	180 x 125	221	107	89	10	1500
491107180140	180 x 140	224	107	95	10	1600
491107180160	180 x 160	225	107	100	8	1750
491107200140	200 x 140	229	114	93	8	2200
491107200160	200 x 160	233	115	100	6	2,420
491107200180	200 x 180	241	116	106	5	2350
491107225160	225 x 160	295	132	123	—	3,100
491107225180	225 x 180	285	130	118	—	3,190
491107225200	225 x 200	272	126	120	—	3,700
491107250160	250 x 160	308	149	100	—	4,100
491107250180	250 x 180	316	151	105	—	4,000
491107250200	250 x 200	324	151	116	—	4,200
491107250225	250 x 225	330	155	122	—	4,700
491107280200	280 x 200	345	140	116	—	11,700
491107280225	280 x 225	335	142	122	—	6,090
491107280250	280 x 250	340	139	135	—	6,500
491107315225	315 x 225	365	150	125	—	8,000
491107315250	315 x 250	365	147	134	—	8,000
491107315280	315 x 280	365	150	145	—	9,000
491107355250	355 x 250	390	164	136	—	11,800
491107355280	355 x 280	390	164	139	—	13,150
491107355315	355 x 315	390	164	150	—	13,000
491107400280	400 x 280	415	179	139	—	17,400
491107400315	400 x 315	415	179	150	—	17,200
491107400355	400 x 355	420	179	164	—	17,800

Maximum Pressure: PN 16 (cold water) | Presión Máxima: PN 16 (agua fria)

Additional dimensions and pressure rated spigots are available upon request

Los tamaños y presiones no enunciados en la tabla están disponibles a pedido

Flex Restraint

49009

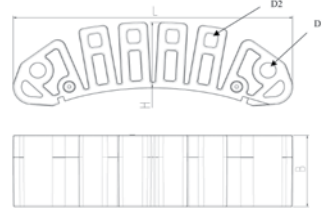

Product Code	Size	L	H	B	D1	D2	UC	W
49009998	160-1600	237	60	65	13.5	11	48	470

* See dedicated tools on page 183 | * Ver herramientas necesarias en pag.183

Flex Restraint

49009

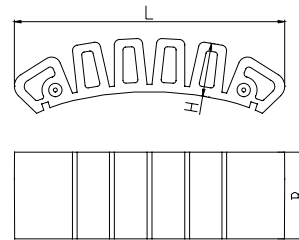

Product Code	Size	L	H	B	UC	W
49009999	160-1600	202	40	65	60	300

* See dedicated tools on page 183 | * Ver herramientas necesarias en pag. 183

Monolithic End Cap

494204

Tapón Monolítico

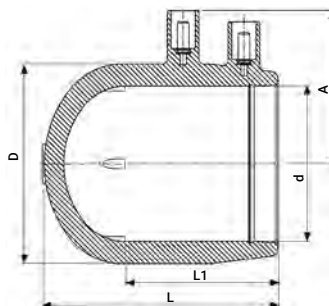

Product Code	Size d	L	L1	D	A	UC	W
494204032	32	63	44	44	46	432	50
494204040	40	70	48	55	51	256	75
494204050	50	82	55	68	56	192	122
494204063	63	95	62	81	62	96	182

End Cap

491204

Tapón

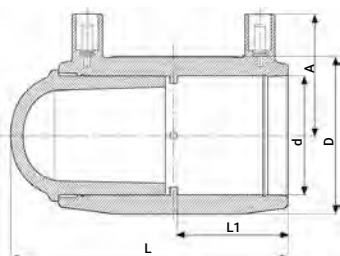

20mm up to 75mm

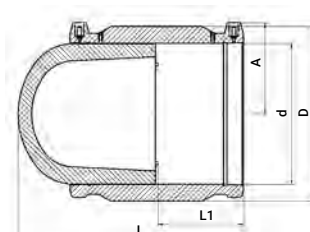

90mm up to 315mm

Product Code	Size d	L	L1	D	A	UC	W
491204020	20	84	37	31	34	400	55
491204025	25	92	40	36	37	400	50
491204032	32	103	42	44	42	300	76
491204040	40	114	47	56	46	160	130
491204050	50	121	49	67	51	120	204
491204063	63	142	57	82	57	72	327
491204075	75	156	61	98	64	48	499
491204090	90	183	73	117	70	30	820
491204110	110	206	78	140	81	20	1259
491204125	125	222	85	157	87	15	1702
491204140	140	237	90	174	97	10	2346
491204160	160	261	93	194	105	6	2990
491204180	180	283	105	218	116	5	4159
491204200	200	289	109	242	126	4	5260
491204225	225	318	119	272	138	2	7260
491204250	250	344	123	311	156	1	8381
491204280	280	396	134	340	170	1	11740
491204315	315	405	139	387	184	2*	16045

* Due to product size, cannot be packed in standard carton | * Cantidad óptima para embalaje en dos pallets apilados

Spigot End Plug

491207

Tapón Espiga

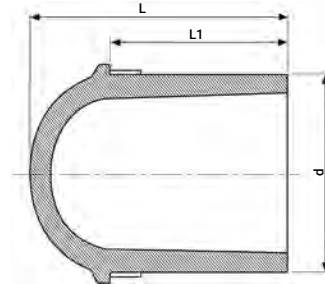

Product Code	Size d	L	L1	UC	W
491207020	20	43	35	2000	8
491207025	25	46	36	1600	10
491207032	32	52	39	960	17
491207040	40	59	43	560	29
491207050	50	68	48	352	52
491207063	63	81	57	192	95
491207075	75	90	60	132	149
491207090	90	105	70	72	250
491207110	110	121	78	57	430
491207125	125	131	82	36	596
491207140	140	142	87	25	797
491207160	160	157	94	18	1149
491207180	180	172	101	14	1600
491207200	200	178	112	10	2089
491207225	225	196	120	6	2800
491207250	250	216	130	4	3920
491207280	280	257	162	3	5300
491207315	315	262	167	2	7200



PE-RT: Polyethylene of Raised Temperature Resistance



PE-RT is a grade of high density polyethylene which has improved Long Term Hydrostatic Strength (LTHS) at elevated temperatures, making it suitable for use in various hot water applications:

- Hot and cold water installations within buildings for central heating systems and potable water for human consumption
- District heating
- Hot wastewater discharge
- Industrial process lines
- Geothermal systems
- Underground conveyance of electrical cables

PE-RT Properties

The long term creep behavior at high temperature has been improved by adjusting the molecular structure to create stronger intermolecular ties.

The improved second generation of PE-RT, "PE-RT Type II", enables production of large pipes and fittings, which gain more and more fields of application where traditional steel pipes can be replaced. PE-RT shares the advantages of PE100 which made it the leading material for plastic pressure pipes:

- Flexibility
- Excellent resistance to impact
- Good weldability that enables making cost effective connections by butt welding or electrofusion

PE-RT Electrofusion Fittings Design And Testing:

The fittings are to be used under specified design pressures and temperatures appropriate to the class of application.

The products are tested and rated for the following pressure classes, according to EN ISO 22391 standard.

Field of Application	Pressure Rating for PLASSON SDR9 Fittings	Application Class, ISO 22391	Temperature/Time at normal temperature	Temperature/Time at maximal temperature	Temperature/Time at peak temperature	Hydrostatic strength tests scheme for PLASSON fittings
Hot Water Supply, 60°C	PN 6	1	60°C/49 years	80°C/1 year	95°C/100 hours	6.4 bar/95°C/ 1100 hours 8.5 bar/80°C/ 1100 hours 19.3 bar/20°C/ 110 hours
Hot Water Supply, 70°C	PN 6	2	70°C/49 years	80°C/1 year	95°C/100 hours	
Underfloor Heating and Low Temperature Radiators	PN 6	4	20°C/2.5 years+ 40°C/20 years+ 60°C/25 years	70°C/2.5 years	100°C/100 hours	
High Temperature Radiators	PN 4	5	20°C/14 years+ 60°C/25 years+ 80°C/10 years	90°C/1 year	100°C/100 hours	

Available products consist of the full range of standard PE100 electrofusion fittings up to diameter 400mm. Above sizes will be provided upon demand.

Tee 90°

490404

Enlace T 90°

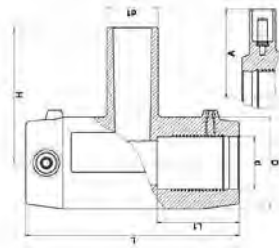

20mm up to 75mm

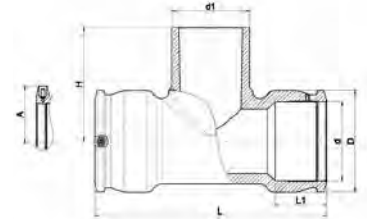

90mm up to 250mm

Product Code	Size dxd1xd	L	L1	D	H	A	UC	W
490404020	20 x 20 x 20	96	37	33	60	39	260	61
490404025	25 x 25 x 25	103	39	44	66	43	168	110
490404032	32 x 32 x 32	104	39	44	74	43	144	97
490404040	40 x 40 x 40	120	43	56	90	47	96	165
490404050	50 x 50 x 50	139	48	68	102	52	56	257
490404063	63 x 63 x 63	167	58	82	119	58	32	417
490404075	75 x 75 x 75	196	63	96	129	62	26	639
490404090	90 x 90 x 90	294	71	113	137	71	15	1090
490404110	110 x 110 x 110	326	71	143	160	81	8	1955
490404125	125 x 125 x 125	382	86	165	177	88	4	2950
490404160	160 x 160 x 160	396	97	209	222	105	3	4758
490404180	180 x 180 x 180	422	106	245	250	116	1	7200
490404200	200 x 200 x 200	451	114	261	265	125	1	8650
490404225	225 x 225 x 225	494	122	293	290	140	1	11860
490404250	250 x 250 x 250	538	129	326	315	152	1	16250

Two Outlets Reducing Tee

492404

Enlace te Reductor con Salida Doble

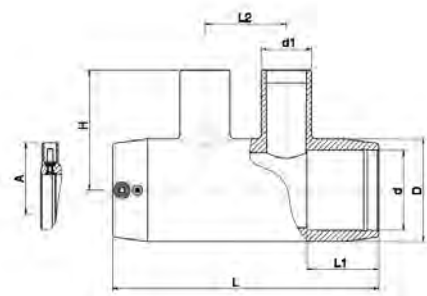

Product Code	Size dxd1 - d1xd	L	L1	L2	D	H	A	UC	W
492404040025	40 x 25 - 25 x 40	176	46	57	56	72	46	96	229
492404040032	40 x 25 - 25 x 40	176	46	57	56	76	46	75	233
492404050025	50 x 25 - 25 x 50	195	49	65	68	79	51	56	342
492404050032	50 x 32 - 32 x 50	195	49	65	68	83	51	58	336
492404050040	50 x 32 - 32 x 50	195	49	65	68	89	51	52	352
492404063025	63 x 32 - 32 x 63	213	58	65	82	86	57	42	457
492404063032	63 x 40 - 40 x 63	213	58	65	82	90	57	40	464
492404063040	63 x 40 - 40 x 63	213	58	65	82	96	57	36	480

Reducing Tee

491404

Enlace T Reductor

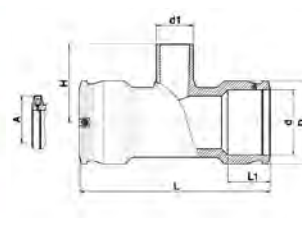
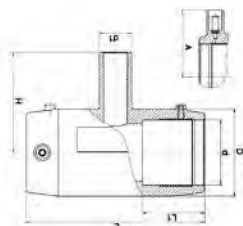

20mm up to 75mm

90mm up to 250mm

Product Code	Size dxd1xd	L	L1	D	H	A	UC	W
491404025020	25 x 20 x 25	104	39	44	66	43	168	108
491404025032	25 x 32 x 25*	104	39	44	74	43	168	116
491404032020	32 x 20 x 32	104	39	44	66	43	144	89
491404032025	32 x 25 x 32	104	39	44	66	43	144	91
491404040020	40 x 20 x 40	120	43	56	72	47	96	151
491404040025	40 x 25 x 40	120	43	56	72	47	96	150
491404040032	40 x 32 x 40	120	43	56	75	47	96	152
491404050020	50 x 20 x 50	139	48	68	78	52	64	224
491404050025	50 x 25 x 50	139	48	68	78	52	64	225
491404050032	50 x 32 x 50	139	48	68	86	52	64	228
491404050040	50 x 40 x 50	139	48	68	90	52	64	237
491404063020	63 x 20 x 63	167	49	82	85	58	40	348
491404063032	63 x 32 x 63	167	58	82	93	58	32	353
491404063040	63 x 40 x 63	167	58	82	104	58	32	365
491404063050	63 x 50 x 63	167	58	82	109	58	32	381
491404075063	75 x 63 x 75	196	63	96	122	62	26	607
491404090063	90 x 63 x 90	294	68	113	124	71	15	1050
491404090075	90 x 75 x 90	293	71	36	14	71	112	137
491404110063	110 x 63 x 110	326	71	143	134	81	9	1715
491404110075	110 x 75 x 110	328	72	143	142	81	9	1730
491404110090	110 x 90 x 110	326	71	143	147	81	8	1815
491404125090	125 x 90 x 125	382	86	165	161	88	5	2805
491404125110	125 x 110 x 125	382	86	165	173	88	5	2859
491404160090	160 x 90 x 160	396	97	209	192	105	3	4185
491404160110	160 x 110 x 160	440	86	208	193	106	3	4470
491404160125	160 x 125 x 160	440	86	208	198	106	3	4470
491404180090	180 x 90 x 180	422	106	245	200	116	2	6090
491404180110	180 x 110 x 180	422	106	245	219	116	2	6270
491404180125	180 x 125 x 180	422	106	245	225	116	2	6410
491404180140	180 x 140 x 180	422	106	245	237	116	1	6610
491404180160	180 x 160 x 180	422	106	245	250	116	1	6950
491404200090	200 x 90 x 200	451	114	261	205	125	2	7140
491404200110	200 x 110 x 200	451	114	261	210	125	2	7235
491404225090	225 x 90 x 225	494	122	293	220	140	1	9900
491404225110	225 x 110 x 225	494	122	293	225	140	1	10000
491404250090	250 x 90 x 250	538	129	326	235	152	1	13350
491404250110	250 x 110 x 250	538	129	326	240	152	1	13400

* This size enlarges | * Esta media agranda

Flanged Tee

499404

Enlace T Bridado

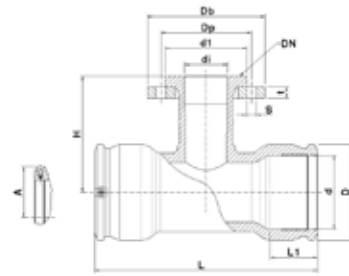

Product Code	Size d x DN x d	L	L1	D	H	A	t	s	d1	DP	UC	W
499404090080	90 x 80 x 90	294	71	113	165	71	20	8 x 18	138	160	8	2835
499404110080	110 x 80 x 110	326	71	143	181	81	20	8 x 18	138	160	6	3560
499404110100	110 x 100 x 110	326	71	143	181	81	22	8 x 18	158	180	6	4240
499404125080	125 x 80 x 125	382	86	165	190	88	20	8 x 18	138	160	4	4550
499404125100	125 x 100 x 125	382	86	165	190	88	22	8 x 18	158	180	3	5180
499404160080	160 x 80 x 160	440	86	208	210	106	20	8 x 18	138	160	3	6245
499404160100	160 x 100 x 160	440	86	208	210	106	22	8 x 18	158	180	3	6785
499404180080	180 x 80 x 180	422	106	245	225	116	20	8 x 18	138	160	2	7745
499404180100	180 x 100 x 180	422	106	245	225	116	22	8 x 18	158	180	1	8550
499404200080	200 x 80 x 200	451	114	261	240	125	20	8 x 18	138	160	1	8530
499404200100	200 x 100 x 200	451	114	261	245	125	22	8 x 18	158	180	1	9230
499404225080	225 x 80 x 225	494	122	293	255	140	20	8 x 18	138	160	1	11240
499404225100	225 x 100 x 225	494	122	293	260	140	22	8 x 18	158	180	1	11900
499404250080	250 x 80 x 250	538	129	326	270	152	20	8 x 18	138	160	1	14750
499404250100	250 x 100 x 250	538	129	326	275	152	22	8 x 18	158	180	1	15400

Elbow 90°

490504

Codo 90°

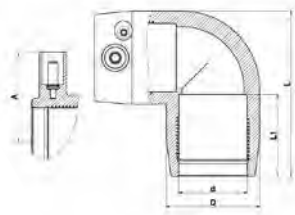

20mm up to 75mm

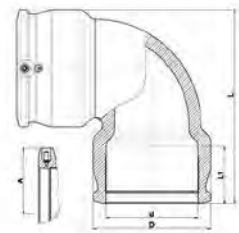

90mm up to 250mm

Product Code	Size d	L	L1	D	A	UC	W
490504020	20	66	35	36	38	320	65
490504025	25	66	37	36	38	320	52
490504032	32	83	40	44	43	192	85
490504040	40	92	44	55	47	120	138
490504050	50	108	48	68	52	72	211
490504063	63	131	57	81	59	40	320
490504075	75	158	69	97	62	33	527
490504090	90	213	78	113	69	19	875
490504110	110	243	79	143	79	9	1519
490504125	125	271	100	165	89	7	2424
490504140	140	309	93	183	94	4	3024
490504160	160	323	87	209	106	3	3990
490504180	180	412	105	244	115	2	7590
490504200	200	449	112	262	124	1	8670
490504225	225	498	121	295	140	1	12200
490504250	250	550	130	327	152	1	13500

Elbow 45°

490604

Codo 45°

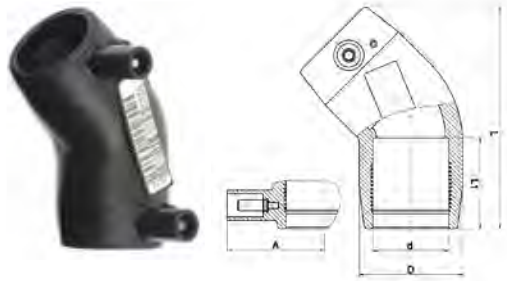

32mm up to 75mm



90mm up to 250mm

Product Code	Size d	L	L1	D	A	UC	W
490604032	32	95	39	45	43	240	75
490604040	40	108	42	55	46	160	117
490604050	50	125	49	68	51	96	181
490604063	63	148	57	81	59	60	264
490604075	75	180	71	96	62	40	426
490604090	90	243	75	112	69	22	759
490604110	110	271	81	143	78	12	1269
490604125	125	304	86	165	88	8	2030
490604140	140	342	92	182	95	5	2471
490604160	160	350	95	209	105	4	3350
490604180	180	434	105	244	114	2	6150
490604200	200	472	112	261	125	1	7050
490604225	225	520	120	294	140	1	9800
490604250	250	571	129	326	151	1	13400

Elbow 22.5°

490804

Codo 22.5°

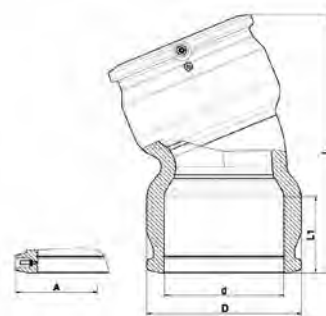

Product Code	Size d	L	L1	D	A	UC	W
490804090	90	214	72	113	71	26	665
490804110	110	232	71	143	81	14	1087
490804125	125	274	86	165	88	8	1850
490804160	160	302	86	209	106	5	2930
490804180	180	391	105	244	115	2	5360

LightFit Elbow 45°

46060

Codo LightFit 45°

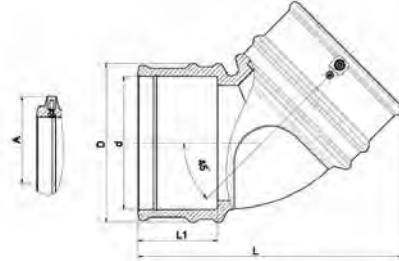

Product Code	Size d	L	L1	D	A	UC	W
460604160	160	323	98	193	106	4	1976

LightFit Elbow 30°

46330

Codo LightFit 30°

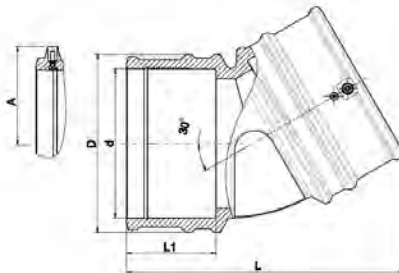

Product Code	Size d	L	L1	D	A	UC	W
463304160	160	300	98	193	106	4	1798

LightFit Elbow 15°

46370

Codo LightFit 15°

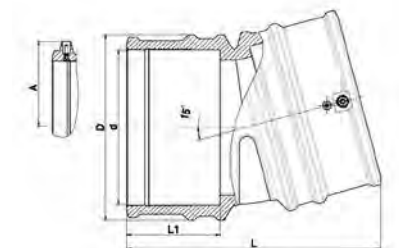

Product Code	Size d	L	L1	D	A	UC	W
463704160	160	265	98	193	106	6	1728

Elbow 180°

490904

Codo 180°

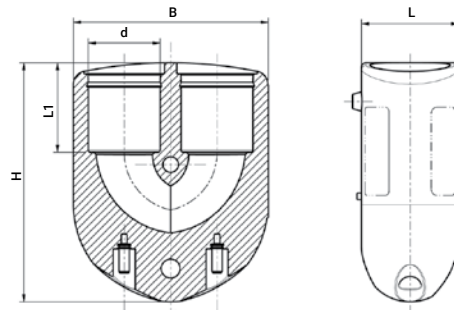

Product Code	Size d	L	L1	H	B	UC	W
490904025	25	38	38	99	72	216	169
490904032	32	44	41	108	88	144	216
490904040	40	53	48	123	106	80	323

Y Reducer

491904

Y Reductor

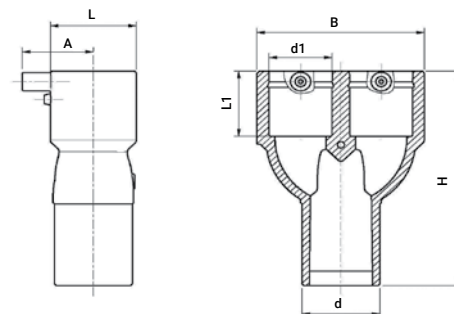

Product Code	Size d x d1 x d1	L	L1	B	A	H	UC	W
491904032025	32 x 25 x 25	36	40	70	38	119	200	97
491904040032	40 x 32 x 32	45	43	87	42	133	120	151
491904050040	50 x 40 x 40	56	46	108	46	151	80	242

Duckfoot Elbow 90°

491504

Codo 90° Empotrable

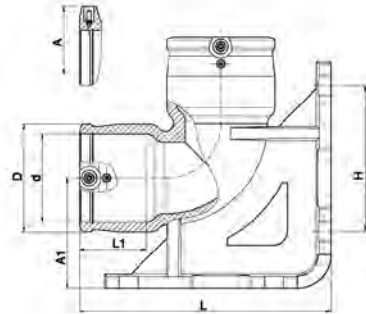

Product Code	Size d	L	L1	D	A	A1	H	UC	W
491504090	90	261	69	112	71	115	146	5	2260

Duckfoot Elbow 90° With Outlet

4915Q4

Codo 90° Emportable con toma de servicio

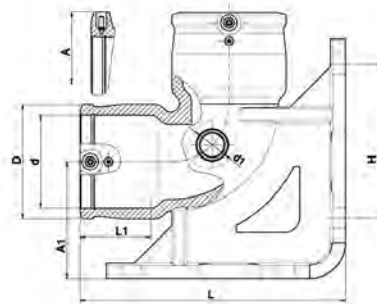

Product Code	Size d x d1	L	L1	D	A	A1	H	UC	W
4915Q4090032	90 x 32	261	69	112	71	115	146	5	2265

Adjustable Elbow

4947C4

Codo Ajustable

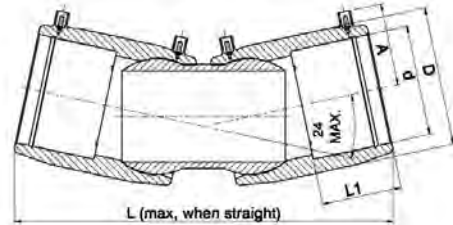

Product Code	Size d	L	L1	D	A	UC	W
4947C4090	90	341	72	116	77	12	1450
4947C4110	110	362	80	140	83	8	2030
4947C4125	125	382	85	157	95	8	2630
4947C4160	160	453	97	215	106	3	4510
4947C4180	180	511	104	224	128	2	7490
4947C4200	200	512	104	250	125	2	9733
4947C4225	225	600	105	282	141	1	13230
4947C4250	250	644	123	312	156	1	16775

Adjustable Elbow One Sided

4947D4

Codo Ajustable Enlace/Espiga

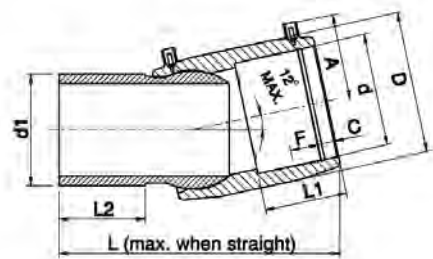

Product Code	Size d x d1	L	L1	L2	D	A	UC	W
4947D4090	90 x 90	258	72	82	116	77	20	940
4947D4110	110 x 110	276	85	85	140	83	12	1290
4947D4125	125 x 125	292	90	90	157	95	12	1740
4947D4160	160 x 160	341	97	100	215	106	4	3150
4947D4180	180 x 180	365	138	138	223	128	3	4210
4947D4200	200 x 200	370	104	116	250	125	2	6172
4947D4225	225 x 225	426	105	124	282	141	2	8340
4947D4250	250 x 250	455	123	134	312	156	1	10800

Balloon Saddle

496804

Collarín Globo

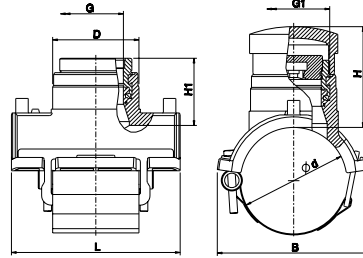

Product Code	Size d x G	G1	B	H	H1	D	L	UC	W
496804090025	90 x 2"	2 1/2"	142	105	70	90	176	10	1961
496804110025	110 x 2"	2 1/2"	160	105	70	90	176	10	1973
496804125025	125 x 2"	2 1/2"	169	105	70	90	176	10	1981
496804140025	140 x 2"	2 1/2"	174	105	70	90	176	10	2000
496804160025	160 x 2"	2 1/2"	176	105	70	90	176	10	1984
496804180025	180 x 2"	2 1/2"	182	105	70	90	176	10	1997
496804200025	200 x 2"	2 1/2"	202	105	70	90	176	10	1991
496804225025	225 x 2"	2 1/2"	227	105	70	90	176	10	2003
496804250025	250 x 2"	2 1/2"	252	105	70	90	176	10	2010

Monolithic Weld End Cap for Balloon Saddle

498304

Tapón Monolítico Soldable para collarín globo

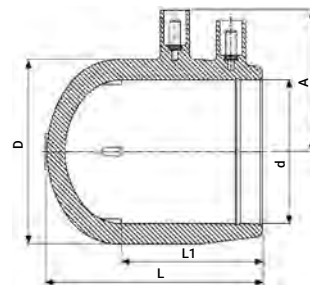

Product Code	Size d	L	L1	D	A	UC	W
498304090	90	123	77	117	77	55	479

Saddle Female Rp Threaded Outlet

4958T4

Collarín BSPP Rosca Hembra

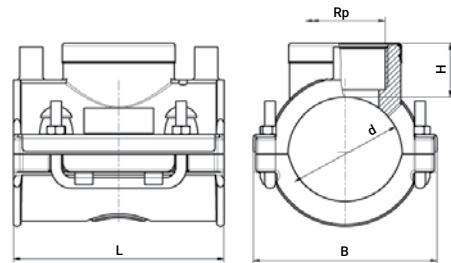

Product Code	Size d x Rp	B	H	L	UC	W
4958T4063007	63 x 3/4"	100	30	118	60	385
4958T4063010	63 x 1"	100	30	118	60	390
4958T4063013	63 x 1 1/4"	100	30	118	60	400
4958T4063015	63 x 1 1/2"	100	30	118	60	400
4958T4090010	90 x 1"	126	30	118	36	520
4958T4090013	90 x 1 1/4"	126	30	118	36	530
4958T4090015	90 x 1 1/2"	126	30	118	36	540

Repair Saddle

495204

Toma de Reparación

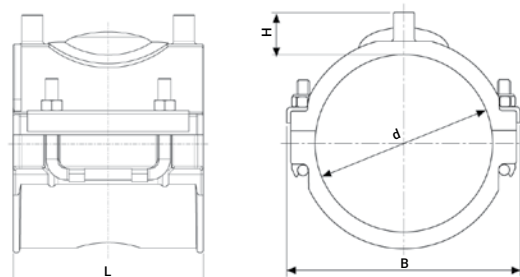

Product Code	Size d	B	H	L	Max Damage Length	UC	W
495204063	63	100	29	118	38	72	378
495204075	75	117	29	118	38	48	410
495204090	90	126	29	118	38	40	504
495204110	110	148	29	118	38	32	555
495204125	125	162	29	118	38	24	620
495204140	140	180	29	118	38	24	660
495204160	160	199	29	118	38	24	718
495204180	180	219	29	118	38	16	759

Transition Saddle

493804

Collarín de Transición



63mm up to 180mm
Outlets 1 1/4" and 1 1/2"



90mm up to 250mm
Outlet 2"

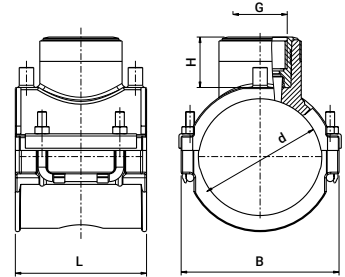

Product Code	Size d x G	B	H	L	UC	W
493804063013	63 x 1 1/4"	100	53	118	48	612
493804075013	75 x 1 1/4"	117	53	118	40	656
493804090015	90 x 1 1/2"	121	53	118	16	930
493804090020	90 x 2"	142	76	176	14	1436
493804110015	110 x 1 1/2"	142	53	118	12	1006
493804110020	110 x 2"	158	76	176	12	1500
493804125015	125 x 1 1/2"	158	53	118	12	1049
493804125020	125 x 2"	166	76	176	12	1510
493804140015	140 x 1 1/2"	175	53	118	10	1072
493804140020	140 x 2"	174	76	176	10	1520
493804160015	160 x 1 1/2"	196	53	118	8	1163
493804160020	160 x 2"	176	76	176	10	1540
493804180015	180 x 1 1/2"	216	53	118	6	1200
493804180020	180 x 2"	182	76	176	10	1500
493804200020	200 x 2"	202	76	176	10	1575
493804225020	225 x 2"	227	76	176	10	1570
493804250020	250 x 2"	252	76	176	10	1546

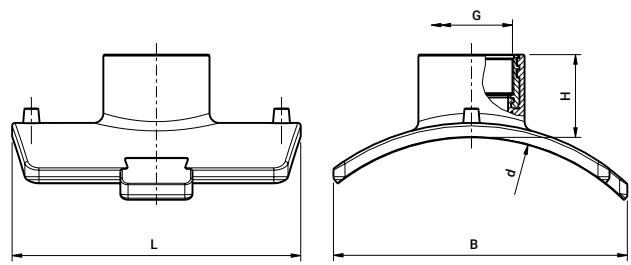

Product Code	Size d x G	B	H	L	UC	W
493804400020*	250-400 x 2"	305	77	306	8	1975
493804710020*	450-800 x 2"	315	77	306	8	1960

* See dedicated tools on page 188 | * Ver herramientas necesarias en pag. 188

PLASSON Electrofusion Saddles

For Large Diameter PE Pipes

PLASSON

ALTERNATIVE



495804 | 5958B



4758W



495904



495803



495204



493804



TRANSPORTING

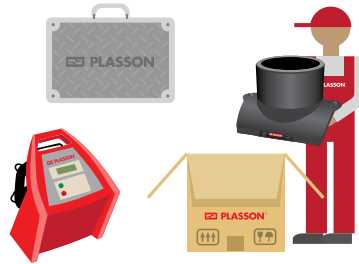

APPLICATION

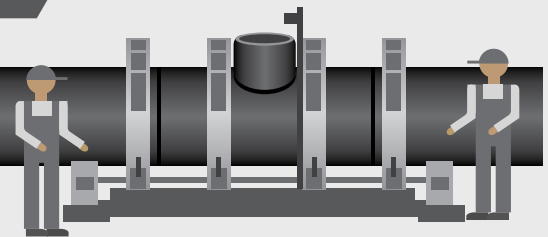
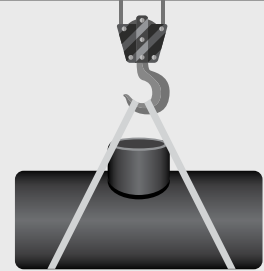

PLASSON SADDLE 450-800X160



STORAGE

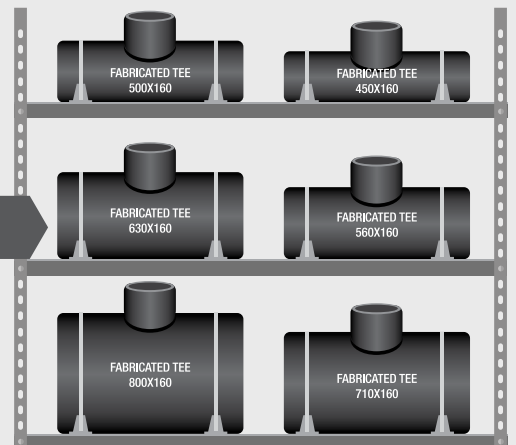
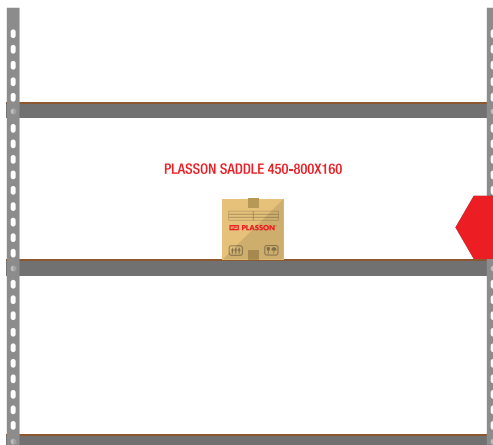



PE has become well established in pipeline applications since its introduction in the 1950s.

The numerous benefits of PE material include its flexibility, corrosion resistance and the option of fully welded systems, all leading to PE systems being used in a wide field of applications and increasingly larger diameters. Plasson, in keeping with latest market trends, continues to develop innovative fittings and installation tools, providing the end users all that is required in order to perform their task in the most convenient and professional way.

Plasson electrofusion fittings are designed for optimal performance using FEA (Final Element Analysis) software. The combination of engineering experience gained over 25 years, and use of leading PE 100 materials in the market provide for an estimated service life of over 100 years.



PLASSON Sensor Adaptor

Plasson Sensor Adaptor provides a dedicated solution for connecting the sensor to the piping system, eliminating the need to apply leak-prone improvised connections. Plasson's Sensor adaptors enable quick and easy integration of various sensors onto a wide range of PE pipe diameters. Pressure rated Water PN16, Gas PE100 SDR11. Threaded brass/Stainless Steel Outlets according to ISO 7-1 (Female Rp thread), available in dimensions 1/2", 3/4" and 1".



Universal

- Two Saddles cover extensive range of pipe diameters:
- 110 (4" IPS) – 400mm (16" IPS)
- 450 (18" IPS) – 1200mm (48" IPS)

Fast and simple installation

The Sensor Adaptor is designed to deal with the challenges of connecting to large PE pipes, such as ovality and deformation resulting from aging, handling and storage by obtaining full contact along the welding zone.

Using one of the two unique yet simple clamping device options (Strap or Bolt) ensures the correct welding of the Sensor Adaptor.

- Correct tightening force indicator on strap mechanism

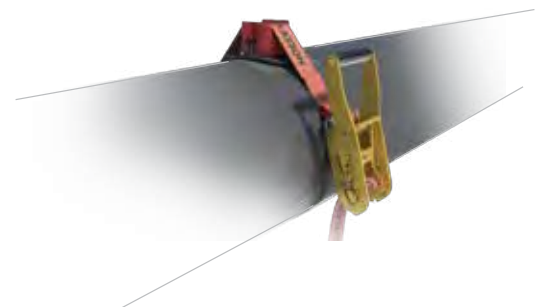

Specifications

The fittings are tested and approved to meet the following standard requirements:

- ISO 4427, Part 3 (Water), ISO 4437, Part 3 (Gas)
- EN 12201, Part 3 (Water), EN 1555, Part 3 (Gas)
- AS/NZS 4129: 2008
- DVGW GW 335-B2

Sensor Adaptor with Brass Thread

493803*

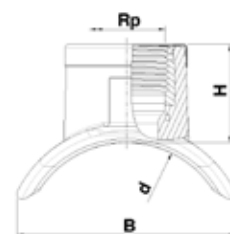
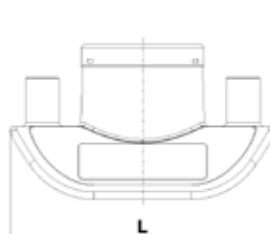

Product Code	Size d x Rp**	B	H	L	UC	W
493803400005	110-400 x 1/2"	85	35	103	140	120
493803400007	110-400 x 3/4"	85	38	103	140	120
493803400010	110-400 x 1"	85	38	103	140	120
493803900005	450-1200 x 1/2"	85	35	103	140	120
493803900007	450-1200 x 3/4"	85	38	103	140	120
493803900010	450-1200 x 1"	85	38	103	140	120

* See dedicated tools on page 183 | * Ver herramientas necesarias en pag. 183

Sensor Adaptor with a Stainless Steel thread

4938S3*

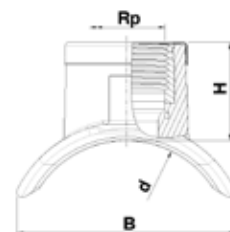
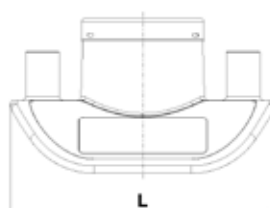

Product Code	Size d x Rp	H	B	L	UC	W
4938S3400005	110-400 x 1/2"	35	85	103	140	109.3
4938S3400007	110-400 x 3/4"	38	85	103	140	120
4938S3400010	110-400 x 1"	38	85	103	140	148.3
4938S3900005	450-1200 x 1/2"	35	85	103	140	109.3
4938S3900007	450-1200 x 3/4"	38	85	103	140	120
4938S3900010	450-1200 x 1"	38	85	103	140	148.3

* See dedicated tools on page 183 | * Ver herramientas necesarias en pag. 183

** NPT thread available upon request

Branch Saddle

495804

Collarín de Derivación



63mm up to 180mm
Outlets 32mm to 63mm



200mm up to 315mm
and all sizes with Outlet 90mm

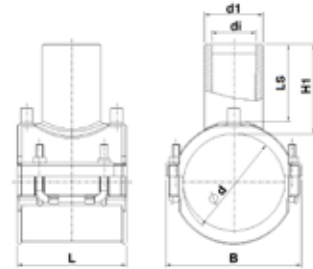

Product Code	Size d x d1	B	H1	LS	L	di	UC	W
495804063032	63 x 32	100	59	49	118	23	56	394
495804063040	63 x 40	100	78	66	118	29.5	40	400
495804063050	63 x 50	100	93	82	118	37.5	40	430
495804063063	63 x 63	100	94	85	118	45	40	462
495804075032	75 x 32	117	59	49	118	23	48	431
495804075040	75 x 40	117	78	66	118	29.5	36	451
495804075050	75 x 50	117	93	82	118	37.5	32	465
495804075063	75 x 63	117	94	85	118	45	32	522
495804090032	90 x 32	126	59	49	118	23	32	519
495804090040	90 x 40	126	78	68	118	29.5	32	529
495804090050	90 x 50	126	93	82	118	37.5	32	550
495804090063	90 x 63	126	94	85	118	45	24	608
495804090090	90 x 90	139	105	90	176	66	15	934
495804110032	110 x 32	148	59	49	118	23	24	585
495804110040	110 x 40	148	78	68	118	29.5	24	598
495804110050	110 x 50	148	93	82	118	37.5	20	629
495804110063	110 x 63	148	94	85	118	45	20	658
495804110090	110 x 90	162	105	90	176	68	18	949
495804125032	125 x 32	162	59	49	118	23	24	634
495804125040	125 x 40	162	78	68	118	29.5	20	644
495804125050	125 x 50	162	93	82	118	37.5	20	670
495804125063	125 x 63	162	94	85	118	45	16	703
495804125090	125 x 90	169	105	90	176	68	18	953
495804140032	140 x 32	180	59	49	118	23	24	661
495804140040	140 x 40	180	78	68	118	29.5	16	677
495804140050	140 x 50	180	93	82	118	37.5	16	705
495804140063	140 x 63	180	94	85	118	45	16	740
495804140090	140 x 90	174	105	90	176	68	16	965
495804160032	160 x 32	200	59	49	118	23	16	744
495804160040	160 x 40	200	78	68	118	29.5	16	757
495804160050	160 x 50	200	93	82	118	37.5	16	778
495804160063	160 x 63	200	94	85	118	45	16	804
495804160090	160 x 90	176	105	90	176	68	16	961
495804180032	180 x 32	219	59	49	118	23	16	800
495804180040	180 x 40	219	78	68	118	29.5	12	800
495804180050	180 x 50	219	93	82	118	37.5	12	828
495804180063	180 x 63	219	94	85	118	45	12	886
495804180090	180 x 90	182	105	90	176	68	15	962
495804200063	200 x 63	202	102	85	176	47	15	862
495804200090	200 x 90	202	105	90	176	68	15	900
495804225063	225 x 63	227	102	85	176	47	15	882
495804225090	225 x 90	227	105	90	176	68	15	983
495804250063	250 x 63	252	102	85	176	47	15	970
495804250090	250 x 90	252	105	90	176	68	15	1070

Branch Saddle*

495804

Collarín de Derivación*

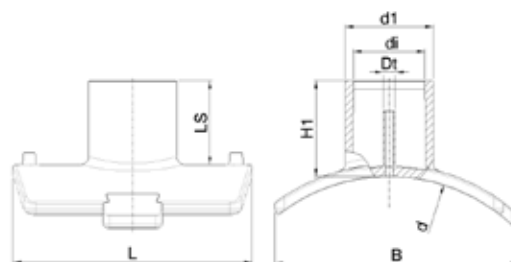

Product Code	Size d x d1	B	H1	LS	L	di	Dt	UC	W
495804400090T	280 - 400 x 90	305	115	102	300	73	16	7	1510
495804400110T	280 - 400 x 110	305	117	104	300	89	16	7	1650
495804400125T	280 - 400 x 125	305	110	119	300	101	16	6	1760
495804400160T	280 - 400 x 160	305	132	119	300	130	16	6	2167
495804710090T	450 - 800 x 90	315	117	105	300	73	16	7	1598
495804710110T	450 - 800 x 110	315	117	105	300	89	16	7	1601
495804710125T	450 - 800 x 125	315	117	109	300	101	16	7	1739
495804710160T	450 - 800 x 160	315	130	115	300	130	16	6	2017

* See dedicated tools on page 188 | * Ver herramientas necesarias en pag. 188

Branch Saddle

4958X4

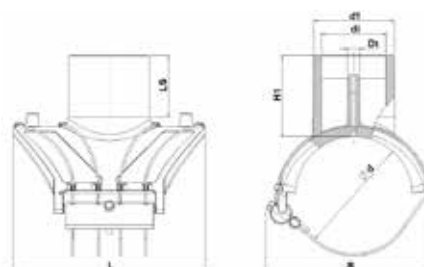

Product Code	Size d x d1	B	H1	LS	L	di	Dt	UC	W
4958X4125090T	125 x 90	180	106	81	242	73	16		—
4958X4125110T	125 x 110	180	109	84	242	89	16		—
4958X4140090T	140 x 90	189	106	81	242	73	16		—
4958X4140110T	140 x 110	189	109	84	242	89	16		—
4958X4160090T	160 x 90	222	107	81	263	73	16	6	—
4958X4160110T	160 x 110	222	110	84	263	89	16	6	—
4958X4180090T	180 x 90	229	107	81	263	73	16	6	—
4958X4180110T	180 x 110	229	110	84	263	89	16	6	—
4958X4200090T	200 x 90	277	109	81	295	73	16	6	—
4958X4200110T	200 x 110	277	111	84	295	89	16	6	—
4958X4225090T	225 x 90	277	109	81	295	73	16	6	—
4958X4225110T	225 x 110	277	112	85	295	89	16	6	—
4958X4250090T	250 x 90	280	109	81	295	73	16	6	—
4958X4250110T	250 x 110	280	111	84	295	89	16	6	—

PLASSON New Branch Saddle



PLASSON has developed a new range of innovative designed branch saddles equipped with an integrated clamping mechanism for a quick, easy and accessory free installation process.

The new branch saddles exceed the performance requirements of the toughest national and international standards in the market.

Our new saddles offer an innovative design, simplifying the installation process by eliminating the need for dedicated clamping tools.

Single bolt

- No clamping tools.
- By tightening the bolt, the cables clamp the saddle to the pipe, ensuring a uniform high quality weld.

Full bore

- Minimal head loss.
- SDR 11 outlet suitable for electrofusion or butt weld connections.

Weld integrity test

- Special test port is incorporated into the saddle, enabling pressure testing of the weld prior to cutting into the pipe mains.

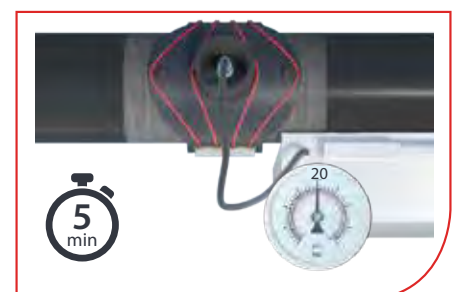

XL&XXL Branch Saddle*

NEW!

495803

XL&XXL Collarín de Derivación*

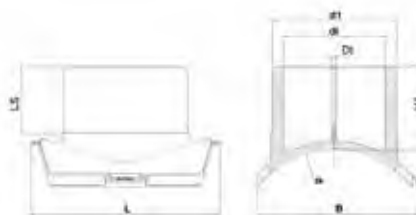

Product Code	d x d1	B	L	di	LS	H1	Dt	UC	W
495803355250T	315-355 x 250	390	420	204	140	200	16	1	7420
495803400180T	400 x 180	393	470	147	135	169	16	1	4800
495803400200T	400 x 200	377	470	163	142	180	16	1	5950
495803400225T	400 x 225	380	470	184	150	189	16	1	6560
495803400250T	400 x 250	400	470	204	160	215	16	1	7900
495803450180T	450 x 180	393	470	147	135	169	16	1	5000
495803450200TN	400-450 x 200	373	420	164	142	182	16	1	5300
495803450225TN	400-450 x 225	373	420	184	142	182	16	1	6050
495803450250T	450 x 250	405	470	204	160	195	16	1	7900
495803450280T	450 x 280	450	530	230	169	225	16	1	10900
495803450315T	450 x 315	450	530	257	180	220	16	1	13000
495803500180T	500 x 180	411	470	147	135	169	16	1	—
495803500200T	500 x 200	398	470	163	142	180	16	1	5870
495803500225T	500 x 225	400	470	184	150	189	16	1	6200
495803500280T	500 x 280	465	530	230	169	225	16	1	10800
495803500315T	500 x 315	480	540	257	180	227	16	1	13500
495803500355T	500 x 355	500	610	252	194	252	16	1	17670
495803560180T	560 x 180	416	470	147	135	169	16	1	—
495803560200T	560 x 200	400	470	163	142	180	16	1	5600
495803560225T	560 x 225	400	470	184	150	189	16	1	6500
495803560280T	560 x 280	477	530	230	169	225	16	1	—
495803560315T	560 x 315	472	540	257	180	227	16	1	12800
495803560355T	560 x 355	512	610	252	194	252	16	1	17200
495803560400T	560 x 400	505	620	327	209	258	16	1	20100
495803630180T	630 x 180	420	470	147	135	169	16	1	—
495803630200TN	500 - 630 x 200	425	420	164	160	185	16	1	5300
495803630225TN	500 - 630 x 225	425	420	184	203	225	16	1	5900
495803630250T	500 - 630 x 250	400	420	205	203	225	16	1	6670
495803630280T	630 x 280	489	530	230	169	225	16	1	10900
495803630315T	630 x 315	481	540	257	180	227	16	1	12700
495803630355T	630 x 355	522	610	252	194	252	16	1	—
495803630400T	630 x 400	520	620	327	209	258	16	1	20400
495803710180T	710 x 180	425	470	147	135	169	16	1	—
495803710200T	710 x 200	410	470	163	142	180	16	1	5780
495803710225T	710 x 225	410	470	184	150	187	16	1	6400
495803710250T	710 x 250	430	470	204	160	195	16	1	7500
495803710280T	710 x 280	498	530	230	169	225	16	1	10900
495803710315T	710 x 315	500	530	257	180	220	16	1	12600
495803710355T	710 x 355	532	610	252	194	252	16	1	—
495803710400T	710 x 400	530	610	327	209	250	16	1	19400
495803800180T	800 x 180	430	470	147	135	169	16	1	4700
495803800200T	800 x 200	410	470	163	142	180	16	1	5790
495803800225T	800 x 225	415	470	184	150	189	16	1	6200
495803800250T	800 x 250	430	470	204	160	197	16	1	7500
495803800280T	800 x 280	505	530	230	169	225	16	1	—
495803800315T	800 x 315	510	530	257	180	220	16	1	12200
495803800355T	800 x 355	543	610	252	194	252	16	1	—
495803800400T	800 x 400	540	610	327	209	250	16	1	20000

* See dedicated tools on page 184 | * Ver herramientas necesarias en pag. 184

XL&XXL Branch Saddle**

NEW!

495803

XL&XXL Collarín de Derivación**

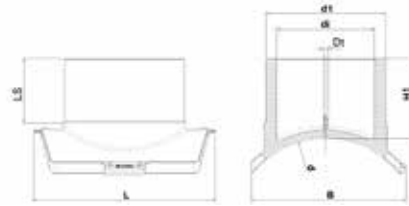

Product Code	d x d1	B	L	di	LS	H1	Dt	UC	W
495803900110T	900 x 110	320	300		105	123	16	6	1900
495803900125T	900 x 125	320	300	101	110	130	16	6	2100
495803900160T	900 x 160	295	300	130	113	131	16	6	2390
495803900180T	900 x 180	435	470	147	135	169	16	1	4600
495803900200T	900 x 200	415	470	163	142	180	16	1	5300
495803900225T	900 x 225	415	470	184	150	189	16	1	—
495803900250T	900 x 250	440	470	204	160	197	16	1	7200
495803900280T	900 x 280	511	530	230	169	225	16	1	10900
495803900315T	900 x 315	510	530	257	180	220	16	1	12100
495803900355T	900 x 355	554	610	252	194	252	16	1	—
495803900400T	900 x 400	550	610	327	209	250	16	1	20000
4958031000110T	1000 x 110*	320	300	89	105	123	16	6	2000
4958031000125T	1000 x 125*	320	300	101	110	128	16	6	2200
4958031000160T	1000 x 160*	320	300	130	120	138	16	6	3000
4958031000180T	1000 x 180*	443	470	147	166	184	16	1	4600
4958031000200T	1000 x 200*	443	470	163	176	198	16	1	5800
4958031000225T	1000 x 225*	443	470	184	181	203	16	1	6200
4958031000250T	1000 x 250*	443	470	204	190	213	16	1	7360
4958031000280T	1000 x 280*	516	530	230	169	225	16	1	—
4958031000315T	1000 x 315*	516	530	257	211	236	16	1	12,320
4958031000355T	1000 x 355*	563	610	252	194	252	16	1	16,830
4958031000400T	1000 x 400*	563	610	327	240	267	16	1	20,000
4958031200110T	1200 x 110*	320	300	89	105	123	16	6	2000
4958031200125T	1200 x 125*	320	300	101	110	128	16	6	2200
4958031200160T	1200 x 160*	320	300	130	120	138	16	6	2500
4958031200180T	1200 x 180*	447	470	147	166	184	16	1	4700
4958031200200T	1200 x 200*	447	470	163	176	198	16	1	5740
4958031200225T	1200 x 225*	447	470	184	181	203	16	1	6350
4958031200250T	1200 x 250*	447	470	204	190	213	16	1	7370
4958031200280T	1200 x 280*	527	530	230	169	225	16	1	—
4958031200315T	1200 x 315*	526	530	257	211	236	16	1	12000
4958031200355T	1200 x 355*	575	610	252	194	252	16	1	—
4958031200400T	1200 x 400*	574	610	327	240	267	16	1	20,000

* Water rating pressure PN10 ** See dedicated tools on page 184 | ** Ver herramientas necesarias en pag.184

LightFit Branch Saddle

4758W

Collarín de Derivación LightFit

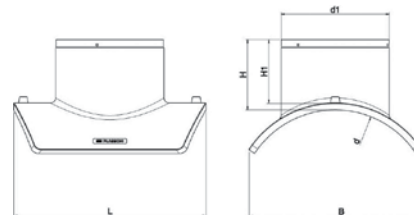

Product Code	d x d1	B	L	H	H1	UC	W
4758W4450225	315 - 450 x 225	359	400	145	130	1	3700
4758W4630225	450 - 630 x 225	389	400	145	130	1	3740
4758W4800225	630 - 800 x 225	407	400	145	130	1	3835

Flange Branch Saddle*

495904

Collarín bridado

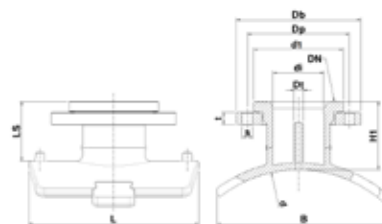

Product Code	d x DN	Flange Type	B	L	H1	dt	DO	Dp	di	d1	t	s	No. Holes	UC	W
495904400080T	280 - 400 x 80	ISO/DIN PN 10/16	305	300	115	16	200	160	73	138	20	18	8	5	2930
495904400100T	280 - 400 x 100	ISO/DIN PN 10/16	309	300	121	16	220	180	101	158	22	18	8	4	3525
495904400150T	280 - 400 x 150	ISO/DIN PN 10/16	305	300	132	16	285	240	131	212	24	18	8	4	6330
495903400250T	400 x 250	ISO/DIN PN 16	400	420	206	16	410	355	204	320	33	26	12	1	16300
495903450200TN	400-450 x 200	ISO/DIN PN 16	373	420	275	16		295	163		28	22	12	1	
495903450250T	450 x 250	ISO/DIN PN 16	405	470	275	16	410	355	204	320	33	26	12	1	—
495903450300T	450 x 300	ISO/DIN PN 16	450	530	275	16	467	410	257	370	40	26	12	1	27300
495903500300T	500 x 300	ISO/DIN PN 16	460	530	275	16	467	410	257	370	40	26	12	1	22700
495903560300T	560 x 300	ISO/DIN PN 16	475	530	275	16	467	410	257	370	40	26	12	1	22750
495903560400T	560 x 400	ISO/DIN PN 16	510	610	280	16	595	525	327	482	54	30	16	1	—
495903630200TN	500 - 630 x 200	ISO/DIN PN 16	405	420	275	16		295	163		28	22	12	1	11900
495903630250T	500 - 630 x 250	ISO/DIN PN 16	425	420	206	16	410	355	204	320	33	26	12	1	15400
495903630300T	630 x 300	ISO/DIN PN 16	490	530	275	16	467	410	257	370	40	26	12	1	27300
495903630400T	630 x 400	ISO/DIN PN 16	520	610	280	16	595	525	327	482	54	30	16	1	—
495903710200T	710 x 200	ISO/DIN PN 16	410	470	275	16	344	295	163	268	28	22	12	1	—
495903710250T	710 x 250	ISO/DIN PN 16	430	470	275	16	410	355	204	320	33	26	12	1	—
495903710300T	710 x 300	ISO/DIN PN 16	500	530	275	16	467	410	257	370	40	26	12	1	—
495903710400T	710 x 400	ISO/DIN PN 16	530	610	280	16	595	525	327	482	54	30	16	1	—
495904710080T	450 - 800 x 80	ISO/DIN PN 10/16	315	300	117	16	200	160	73	138	20	18	8	5	2960
495904710100T	450 - 800 x 100	ISO/DIN PN 10/16	315	300	123	16	220	180	101	158	22	18	8	4	3530
495904710150T	450 - 800 x 150	ISO/DIN PN 10/16	315	300	132	16	285	240	131	212	24	18	8	4	6300
495903800200T	800 x 200	ISO/DIN PN 16	410	470	275	16	344	295	163	268	28	22	12	1	12270
495903800250T	800 x 250	ISO/DIN PN 16	430	470	275	16	410	355	204	320	33	26	12	1	—
495903800300T	800 x 300	ISO/DIN PN 16	510	530	275	16	467	410	257	370	40	26	12	1	27600
495903800400T	800 x 400	ISO/DIN PN 16	540	610	280	16	595	525	327	482	54	30	16	1	45800
495903900150T	900 x 150	ISO/DIN PN 10/16	318	300	132	16	285	240	131	212	24	18	8	2	6640
495903900200T	900 x 200	ISO/DIN PN 16	415	470	275	16	344	295	163	268	28	22	12	1	—
495903900250T	900 x 250	ISO/DIN PN 16	440	470	275	16	410	355	275	320	33	26	12	1	—
495903900300T	900 x 300	ISO/DIN PN 16	530	530	275	16	467	410	257	370	40	26	12	1	—
495903900400T	900 x 400	ISO/DIN PN 16	550	610	280	16	595	525	327	482	54	30	16	1	—
4959031000100T	1000 x 100	ISO/DIN PN 10/16	320	300	110	16	220	180	101	158	22	18	8	4	—
4959031000150T	1000 x 150	ISO/DIN PN 10/16	320	300	121	16	285	240	131	212	24	18	8	—	—
4959031000200T	1000 x 200	ISO/DIN PN 16	443	470	250	16	344	295	159	268	28	22	12	—	—
4959031000250T	1000 x 250	ISO/DIN PN 16	443	470	250	16	410	355	199	320	33	26	12	—	—
4959031000300T	1000 x 300	ISO/DIN PN 16	516	530	250	16	467	410	251	370	40	26	12	—	—
4959031000400T	1000 x 400	ISO/DIN PN 16	563	610	250	16	595	525	319	482	54	30	16	—	—
4959031200100T	1200 x 100	ISO/DIN PN 10/16	320	300	110	16	220	180	101	158	22	18	8	4	—
4959031200150T	1200 x 150	ISO/DIN PN 10/16	320	300	121	16	285	240	131	212	24	18	8	—	—
4959031200200T	1200 x 200	ISO/DIN PN 16	447	470	250	16	344	295	159	268	28	22	12	—	—
4959031200250T	1200 x 250	ISO/DIN PN 16	447	470	250	16	410	355	199	320	33	26	12	—	—
4959031200300T	1200 x 300	ISO/DIN PN 16	523	530	250	16	467	410	251	370	40	26	12	—	—
4959031200400T	1200 x 400	ISO/DIN PN 16	574	610	250	16	595	525	319	482	54	30	16	—	—

* See dedicated tools on page 184 | * Ver herramientas necesarias en pag. 184

Flanged Branch Saddles DN100

4959X4

Collarín Bridado DN 100



Product Code	d x DN	L	B	H1*	LS*	Db	Dp	dh	di	Dt	t	s	No. Holes
4959X4125100T	125X100	242	180	123	110	220	180	158	87	16	22	18	8
4959X4140100T	140X100	242	186	123	110	220	180	158	87	16	22	18	8
4959X4160100T	160X100	263	219	124	110	220	180	158	87	16	22	18	8
4959X4180100T	180X100	263	229	124	110	220	180	158	87	16	22	18	8
4959X4200100T	200X100	295	277	125	110	220	180	158	87	16	22	18	8
4959X4225100T	225X100	295	272	125	110	220	180	158	87	16	22	18	8
4959X4250100T	250X100	295	280	125	110	220	180	158	87	16	22	18	8

* May be customized according to customer's requirements.

Repair Saddle

495204

Collarín de reparación

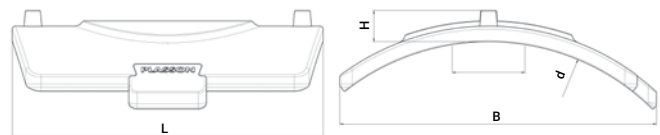

Product Code	Size d	B	H	L	Max Damage Length	UC	W
495204900	250-900	305	30	300	70	24	1500

Tapping Saddle

496304

Toma de Servicio



40mm up to 63mm 75mm up to 180mm 200mm up to 250mm

Product Code	Type*	Size d x d1	H	B	H1	H2	L	Welding Cap Type	UC	W
496304040020	mb	40 x 20	107	66	7	94	100	Type C	52	290
496304040025	mb	40 x 25	90	65	7	98	100	Type C	52	349
496304040032	mb	40 x 32	121	66	11	94	100	Type C	52	370
496304050020	mb	50 x 20	110	76	7	98	100	Type C	52	390
496304050025	mb	50 x 25	91	76	10	98	100	Type C	50	390
496304050032	mb	50 x 32	122	76	12	98	100	Type C	45	390
496304063020N	mb	63 x 20	90	100	10	90	118	Type C	40	362
496304063025N	mb	63 x 25	93	100	12	36	118	Type C	40	364
496304063032N	mb	63 x 32	99	100	12	90	118	Type C	40	369
496304063040		63 x 40	142	100	64	177	118	Type A	16	1080
496304063050		63 x 50	154	100	64	177	118	Type A	16	1099
496304063063		63 x 63	175	100	64	177	118	Type A	16	962
496304075020		75 x 20	125	117	50	177	118	Type A	16	1120
496304075032		75 x 32	132	117	56	177	118	Type A	16	1091
496304075040		75 x 40	142	117	60	177	118	Type A	16	1124
496304075050		75 x 50	123	117	64	177	118	Type A	16	1140
496304075063		75 x 63	175	117	64	177	118	Type A	16	1228
496304090020	mb	90 x 20	117	126	16	114	118	Type B	20	900
496304090025	mb	90 x 25	108	126	16	114	118	Type B	20	1120
496304090032	mb	90 x 32	126	126	16	114	118	Type B	20	778
496304090040	mb	90 x 40	134	126	21	114	118	Type B	20	1130
496304090050		90 x 50	123	126	64	177	118	Type A	14	1220
496304090063		90 x 63	175	126	64	177	118	Type A	14	1300

* Please note: mb = Mono Block | * Nota: mb = monobloque

Tapping Saddle

496304

Toma de Servicio



Product Code	Type*	Size d x d1	H	B	H1	H2	L	Welding Cap Type	UC	W
496304110020	mb	110 x 20	119	148	16	114	118	Type B	20	964
496304110025	mb	110 x 25	118	148	16	114	118	Type B	20	830
496304110032	mb	110 x 32	127	148	16	114	118	Type B	20	970
496304110040	mb	110 x 40	138	148	21	114	118	Type B	20	1000
496304110050		110 x 50	123	148	64	177	118	Type A	12	1300
496304110063		110 x 63	175	148	64	177	118	Type A	12	1383
496304125020	mb	125 x 20	116	162	16	114	118	Type B	15	1220
496304125025	mb	125 x 25	95	162	16	114	118	Type B	15	880
496304125032	mb	125 x 32	131	162	16	114	118	Type B	15	899
496304125040	mb	125 x 40	141	162	21	114	118	Type B	15	1280
496304125050		125 x 50	123	162	64	177	118	Type A	12	1345
496304125063		125 x 63	175	162	64	177	118	Type A	12	1426
496304140020		140 x 20	125	180	50	177	118	Type A	12	1340
496304140032		140 x 32	132	180	56	177	118	Type A	12	1330
496304140040		140 x 40	142	180	60	177	118	Type A	12	1360
496304140050		140 x 50	123	180	64	177	118	Type A	12	1382
496304140063		140 x 63	175	180	64	177	118	Type A	12	1468
496304160020	mb	160 x 20	118	199	21	138	118	Type A	10	1360
496304160025	mb	160 x 25	100	199	21	138	118	Type A	10	1170
496304160032	mb	160 x 32	144	199	16	138	118	Type A	10	1320
496304160040	mb	160 x 40	157	199	21	138	118	Type A	10	1216
496304160050	mb	160 x 50	175	199	24	138	118	Type A	10	1375
496304160063	mb	160 x 63	197	199	20	138	118	Type A	10	1390
496304180020		180 x 20	125	219	50	177	118	Type A	10	1550
496304180025	mb	180 x 25	110	219	18	138	118	Type A	10	1100
496304180032	mb	180 x 32	144	219	18	138	118	Type A	10	1565
496304180040	mb	180 x 40	155	219	21	138	118	Type A	10	1274
496304180050	mb	180 x 50	174	219	24	138	118	Type A	10	1595
496304180063	mb	180 x 63	197	219	20	138	118	Type A	10	1605
496304200020		200 x 20	125	202	50	177	176	Type A	8	1425
496304200032		200 x 32	132	202	56	177	176	Type A	8	1451
496304200040		200 x 40	142	202	60	177	176	Type A	8	1471
496304200050		200 x 50	123	202	64	177	176	Type A	8	1496
496304200063		200 x 63	175	202	64	177	176	Type A	8	1579
496304225020		225 x 20	125	227	50	177	176	Type A	8	1370
496304225032		225 x 32	132	227	56	177	176	Type A	8	1450
496304225040		225 x 40	142	227	60	177	176	Type A	8	1485
496304225050		225 x 50	123	227	64	177	176	Type A	8	1506
496304225063		225 x 63	175	227	64	177	176	Type A	8	1589
496304250020		250 x 20	125	252	50	177	176	Type A	8	1455
496304250032		250 x 32	132	252	56	177	176	Type A	8	1464
496304250040		250 x 40	142	252	60	177	176	Type A	8	1582
496304250050		250 x 50	123	252	64	177	176	Type A	8	1589
496304250063		250 x 63	175	252	64	177	176	Type A	8	1386

* Please note: mb = Mono Block | * Nota: mb = monobloque

Tapping Saddle Parallel Outlet

4963P4

Toma de Servicio salida Parallel Outlet

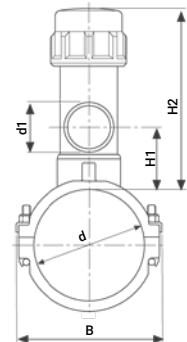
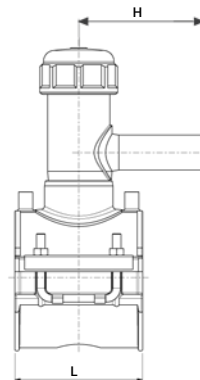

Product Code	Size d x d1	H	B	H1	H2	L	Welding Cap Type	UC	W
4963P4063020	63 x 20	125	100	50	177	118	Type A	16	—
4963P4063032	63 x 32	132	100	56	177	118	Type A	16	1042
4963P4063040	63 x 40	142	100	60	177	118	Type A	16	—
4963P4063050	63 x 50	123	100	64	177	118	Type A	16	906
4963P4063063	63 x 63	175	100	64	177	118	Type A	16	—
4963P4075020	75 x 20	125	117	50	177	118	Type A	16	—
4963P4075032	75 x 32	132	117	56	177	118	Type A	16	1120
4963P4075040	75 x 40	142	117	60	177	118	Type A	16	—
4963P4075050	75 x 50	123	117	64	177	118	Type A	16	—
4963P4075063	75 x 63	175	117	64	177	118	Type A	16	—
4963P4090020	90 x 20	125	126	50	177	118	Type A	14	—
4963P4090032	90 x 32	132	126	56	177	118	Type A	14	1120
4963P4090040	90 x 40	142	126	60	177	118	Type A	14	1130
4963P4090050	90 x 50	123	126	64	177	118	Type A	14	—
4963P4090063	90 x 63	175	126	64	177	118	Type A	14	—
4963P4110020	110 x 20	125	148	50	177	118	Type A	12	—
4963P4110032	110 x 32	132	148	56	177	118	Type A	12	1175
4963P4110040	110 x 40	142	148	60	177	118	Type A	12	1179
4963P4110050	110 x 50	123	148	64	177	118	Type A	12	1195
4963P4110063	110 x 63	175	148	64	177	118	Type A	12	1236
4963P4125020	125 x 20	125	162	50	177	118	Type A	10	—
4963P4125032	125 x 32	132	162	56	177	118	Type A	10	1298
4963P4125040	125 x 40	142	162	60	177	118	Type A	10	—
4963P4125050	125 x 50	123	162	64	177	118	Type A	10	—
4963P4125063	125 x 63	175	162	64	177	118	Type A	10	1430
4963P4140020	140 x 20	125	180	50	177	118	Type A	10	—
4963P4140032	140 x 32	132	180	56	177	118	Type A	10	—
4963P4140040	140 x 40	142	180	60	177	118	Type A	10	—
4963P4140050	140 x 50	123	180	64	177	118	Type A	10	1348
4963P4140063	140 x 63	175	180	64	177	118	Type A	10	—
4963P4160020	160 x 20	125	199	50	177	118	Type A	10	—
4963P4160032	160 x 32	132	199	56	177	118	Type A	10	1304
4963P4160040	160 x 40	142	199	60	177	118	Type A	10	1327
4963P4160050	160 x 50	123	199	64	177	118	Type A	10	1348
4963P4160063	160 x 63	175	199	64	177	118	Type A	10	1399
4963P4180020	180 x 20	125	219	50	177	118	Type A	8	—
4963P4180032	180 x 32	132	219	56	177	118	Type A	10	1304
4963P4180040	180 x 40	142	219	60	177	118	Type A	8	—
4963P4180050	180 x 50	123	219	64	177	118	Type A	8	—
4963P4180063	180 x 63	175	219	64	177	118	Type A	8	1304
4963P4200020	200 x 20	125	202	50	177	176	Type A	8	—
4963P4200032	200 x 32	132	202	56	177	176	Type A	8	1455
4963P4200040	200 x 40	142	202	60	177	176	Type A	8	—
4963P4200050	200 x 50	123	202	64	177	176	Type A	8	—
4963P4200063	200 x 63	175	202	64	177	176	Type A	8	1590
4963P4225020	225 x 20	125	227	50	177	176	Type A	8	—
4963P4225032	225 x 32	132	227	56	177	176	Type A	8	1455
4963P4225040	225 x 40	142	227	60	177	176	Type A	8	—
4963P4225050	225 x 50	123	227	64	177	176	Type A	8	—
4963P4225063	225 x 63	175	227	64	177	176	Type A	8	1455
4963P4250020	250 x 20	125	252	50	177	176	Type A	8	—
4963P4250032	250 x 32	132	252	56	177	176	Type A	8	1470
4963P4250040	250 x 40	142	252	60	177	176	Type A	8	—
4963P4250050	250 x 50	123	252	64	177	176	Type A	8	—
4963P4250063	250 x 63	175	252	64	177	176	Type A	8	1470

High Volume Tapping Tee (HVTT)

491304

Toma en carga de alto volumen

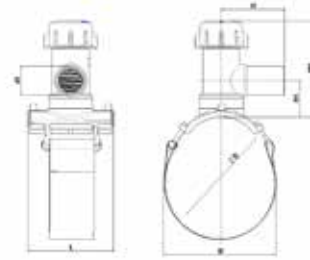

Product Code	size d x d1	B	L	H	H1	H2	Cutter Dia.	UC	W
491304090063	90 x 63	139	176	130	75	195	47	—	—
491304110063	110 x 63	156	176	130	75	195	47	—	—
491304125063	125 x 63	165	176	130	75	195	47	—	—
491304140063	140 x 63	171	176	130	75	195	47	—	—
491304160063	160 x 63	173	176	130	75	195	47	—	—
491304180063	180 x 63	176	176	130	75	195	47	—	—
491304200063	200 x 63	178	176	130	75	195	47	—	—
491304225063	225 x 63	180	176	130	75	195	47	—	—
491304250063	250 x 63	180	176	130	75	195	47	—	—
491304280063	280 x 63	180	176	130	75	195	47	—	—
491304315063	315 x 63	183	176	130	75	195	47	—	—
491304400063*	280-400 x 63	300	306	130	85	208	47	—	—

* No under clamp. Clamping tools required

Welding Cap for Tapping Saddle

498304

Tapón Soldable para toma de servicio

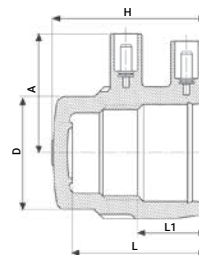

Product Code	Type	Size	D	A	H	L	L1	UC	W
498304057	Type A	57	74	59	74	63	36	128	157
498304050	Type B	50	62	54	73	66	30	192	111
498304040	Type C	40	51	49	63	55	26	256	73

PE Ball Valve

436207

Válvula de Bola PE

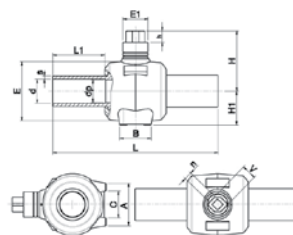

Product Code	Size d	dp	s	L	L1	B	E	E1	H	H1	h	C	V	U	UC	W
436207025	25*	19	3	300	103	65	80	70	94	50	40	39	50	26	12	705
436207032	32*	24	3	300	103	65	80	70	94	50	40	39	50	26	12	855
436207040	40	24	4	300	103	65	80	70	94	50	40	39	50	26	12	758
436207050	50*	39	6	414	130	87	120	85	160	80	40	54	50	26	4	2091
436207063	63*	48	6	414	130	87	120	85	160	80	40	54	50	26	4	2061
436207075	75	48	8	414	130	87	120	85	160	80	40	54	50	26	4	2558
436207090	90*	70	8	550	176	93	200	85	200	110	40	90	50	26	2	5865
436207110	110*	86	10	550	178	93	200	85	200	110	40	90	50	26	2	5761
436207125	125	86	12	550	182	93	200	85	200	110	40	90	50	26	2	6400
436207160	160	86	16	550	182	93	200	85	200	110	40	90	50	26	2	7100

* Full Bore Dimensions | * Dimensiones de cavidad única

PE Ball Valve with Two Purges

436Q7

PE Ball Válvula de Bola con purga

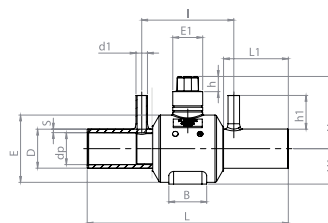

Product Code	Size d	d1	A	H	H1	L	L1	B	Dp	S	I	E	E1	h	c	UC	W
4362Q7090	90	32	146	200	110	550	176	107	70	9	251	187	85	40	90	2	5606
4362Q7110	110	32	146	200	110	550	176	107	84	10	251	188	85	40	90	2	5784

Tapping Valve

4954S4*/495404

Toma de Servicio con Válvula



63mm up to 180mm



200mm up to 250mm

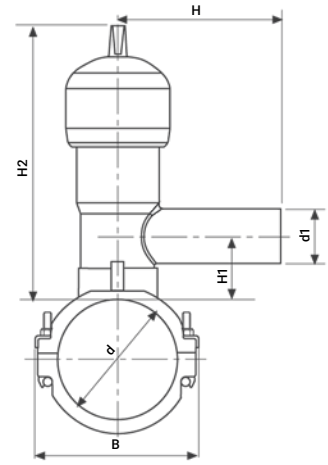

Product Code	Size d x d1	B	H	H1	H2	L	UC	W
495404063032	63 x 32	99	126	46	244	118	8	2090
495404063040	63 x 40	99	137	46	244	118	8	2103
495404063050	63 x 50	99	152	51	244	118	8	2140
495404063063	63 x 63	99	186	51	244	118	8	2205
495404075032	75 x 32	117	126	46	244	118	8	2100
495404075040	75 x 40	117	137	46	244	118	8	2113
495404075050	75 x 50	117	152	51	244	118	8	2150
495404075063	75 x 63	117	186	51	244	118	8	2215
495404090032	90 x 32	126	126	46	244	118	8	2150
495404090040	90 x 40	126	137	46	244	118	8	2163
495404090050	90 x 50	126	152	51	244	118	8	2200
495404090063	90 x 63	126	186	51	244	118	8	2265
495404110032	110 x 32	148	126	46	244	118	8	2267
495404110040	110 x 40	148	137	46	244	118	8	2250
495404110050	110 x 50	148	152	51	244	118	8	2280
495404110063	110 x 63	148	186	51	244	118	8	2345
495404125032	125 x 32	162	126	46	244	118	8	2277
495404125040	125 x 40	162	137	46	244	118	8	2290
495404125050	125 x 50	162	152	51	244	118	8	2327
495404125063	125 x 63	162	186	51	244	118	8	2392
495404140032	140 x 32	180	126	46	244	118	8	2285
495404140040	140 x 40	180	137	46	244	118	8	2298
495404140050	140 x 50	180	152	51	244	118	8	2335
495404140063	140 x 63	180	186	51	244	118	8	2441
495404160032	160 x 32	202	126	46	244	118	8	2377
495404160040	160 x 40	202	137	46	244	118	8	2390
495404160050	160 x 50	202	152	51	244	118	8	2427
495404160063	160 x 63	202	186	51	244	118	8	2492
495404180032	180 x 32	220	126	46	244	118	8	2440
495404180040	180 x 40	220	137	46	244	118	8	2453
495404180050	180 x 50	220	152	51	244	118	8	2490
495404180063	180 x 63	220	186	51	244	118	8	2555
495404200032	200 x 32	202	126	46	244	176	5	2431
495404200040	200 x 40	202	137	46	244	176	5	2444
495404200050	200 x 50	202	152	51	244	176	5	2481
495404200063	200 x 63	202	186	51	244	176	5	2546
495404225032	225 x 32	227	126	46	244	176	5	2448
495404225040	225 x 40	227	137	46	244	176	5	2501
495404225050	225 x 50	227	152	51	244	176	5	2538
495404225063	225 x 63	227	186	51	244	176	5	2603
495404250032	250 x 32	252	126	46	244	176	5	2504
495404250040	250 x 40	252	137	46	244	176	5	2517
495404250050	250 x 50	252	152	51	244	176	5	2554
495404250063	250 x 63	252	186	51	244	176	5	2619

* Tapping Valve with serrated edge cutter.

* Toma de servicio con bordes "dientes de sierra".

Male Transition Coupler

492104

Enlace de Transición Macho



Type A

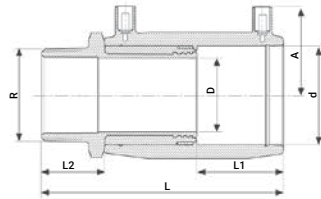

Type B

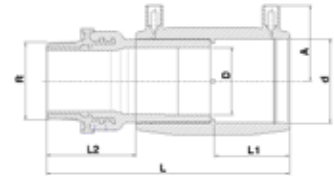

Product Code	Size d x R	Type	L	L1	L2	D	A	UC	W
492104020005	20 x 1/2"	A	105	37	29	14	34	200	129
492104025007	25 x 3/4"	A	111	40	29	19	37	150	150
492104032005	32 x 1/2"	A	110	39	29	23	42	100	142
492104032007	32 x 3/4"	A	110	39	29	23	42	100	263
492104032010	32 x 1"	B	140	44	50	22	43	100	285
492104032013	32 x 1 1/4"	A	124	42	36	23	42	60	393
492104032015	32 x 1 1/2"	A	124	42	36	23	42	60	404
492104040010	40 x 1"	B	143	48	45	22	46	72	409
492104040013	40 x 1 1/4"	B	153	48	55	30	46	54	470
492104040015	40 x 1 1/2"	A	133	47	36	29	46	54	483
492104040020	40 x 2"	A	160	44	41	29	59	36	500
492104050010	50 x 1"	A	135	49	34	38	51	48	513
492104050013	50 x 1 1/4"	A	137	49	36	38	51	48	569
492104050015	50 x 1 1/2"	B	164	49	63	35	51	48	547
492104050020	50 x 2"	A	160	49	41	38	59	30	752
492104063013	63 x 1 1/4"	A	153	57	36	48	57	30	884
492104063015	63 x 1 1/2"	A	153	57	36	48	57	30	845
492104063020	63 x 2"	B	186	57	69	47	58	30	921
492104075020	75 x 2"	A	167	61	41	59	64	16	1305
492104075025	75 x 2 1/2"	A	172	61	46	59	64	16	1512

Female Transition Coupler

493104

Enlace de Transición Hembra



Type A

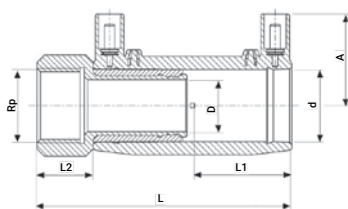

Type B

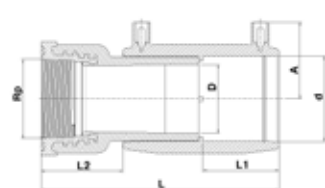

Product Code	Size d x Rp	Type	L	L1	L2	D	A	UC	W
493104020005	20 x 1/2"	A	96	37	20	14	35	200	130
493104025007	25 x 3/4"	A	105	40	23	19	38	150	145
493104025010	25 x 1"	A	108	34	28	23	42	80	252
493104032007	32 x 3/4"	A	124	39	23	19	42	100	159
493104032010	32 x 1"	B	130	44	40	27	43	100	265
493104032013	32 x 1 1/4"	A	118	39	28	29	47	54	507
493104032015	32 x 1 1/2"	A	124	39	25	38	47	50	455
493104040010	40 x 1"	A	122	47	25	29	46	54	507
493104040013	40 x 1 1/4"	A	122	47	25	29	46	54	407
493104040015	40 x 1 1/2"	A	122	47	25	29	46	48	419
493104040020	40 x 2"	A	150	44	32	38	59	32	821
493104050015	50 x 1 1/2"	A	126	49	25	38	51	48	491
493104050020	50 x 2"	A	131	49	30	38	51	40	685
493104063015	63 x 1 1/2"	A	145	59	26	38	59	24	558
493104063020	63 x 2"	B	179	57	62	49	58	30	840

Male Transition Elbow 90°

492504

Codo de Transición de 90° Macho

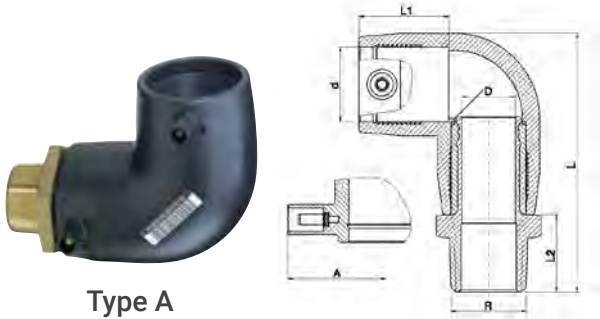

Type A

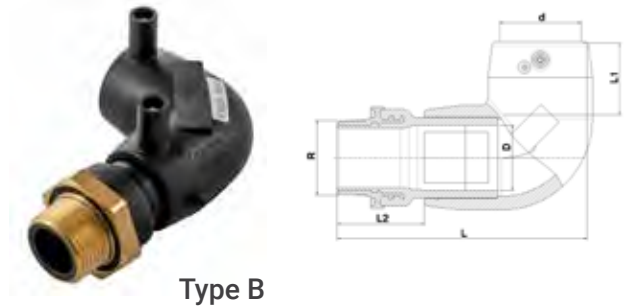

Type B

Product Code	Size d x R	Type	L	L1	L2	D	A	UC	W
492504020005	20 x 1/2"	A	95	35	29	14	38	150	153
492504025007	25 x 3/4"	A	95	37	29	19	38	120	168
492504032005	32 x 1/2"	A	112	40	29	23	43	84	294
492504032007	32 x 3/4"	A	112	40	29	23	43	84	262
492504032010	32 x 1"	B	134	44	49	22	47	84	300
492504032013	32 x 1 1/4"	A	119	40	36	23	43	60	419
492504032015	32 x 1 1/2"	A	119	40	36	23	43	60	436
492504040010	40 x 1"	B	142	44	49	22	47	48	458
492504040013	40 x 1 1/4"	B	153	44	59	30	47	48	500
492504040015	40 x 1 1/2"	A	128	44	36	29	47	48	510
492504040020	40 x 2"	A	133	44	41	29	47	48	725
492504050010	50 x 1"	A	142	48	34	38	52	42	624
492504050013	50 x 1 1/4"	A	144	48	36	38	52	36	679
492504050015	50 x 1 1/2"	B	174	49	63	35	52	36	655
492504050020	50 x 2"	A	149	48	41	38	52	30	806
492504063013	63 x 1 1/4"	A	167	57	36	48	59	24	985
492504063015	63 x 1 1/2"	A	167	57	36	48	59	24	1040
492504063020	63 x 2"	B	200	58	68	47	57	24	1015
492504075020	75 x 2"	A	199	69	41	59	62	16	1450
492504075025	75 x 2 1/2"	A	204	69	46	59	62	16	1649

Female Transition Elbow 90°

493504

Codo de Transición de 90° Hembra

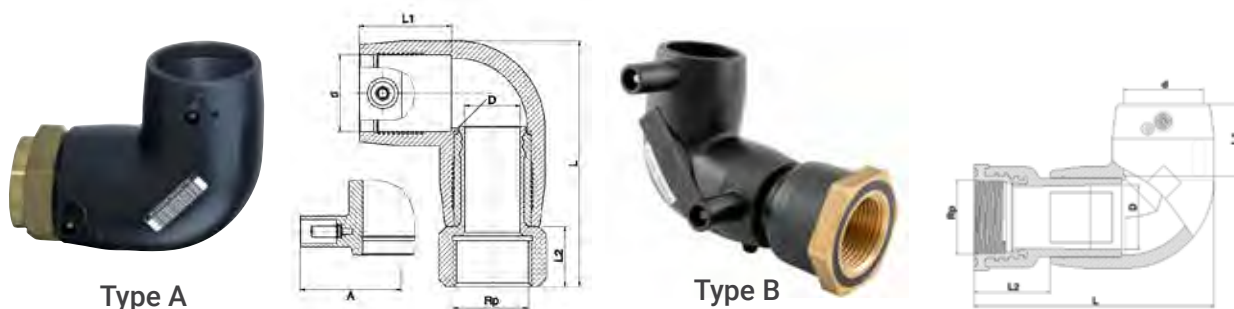

Product Code	Size d x Rp	Type	L	L1	L2	D	A	UC	W
493504020005	20 x 1/2"	A	86	35	20	14	38	160	142
493504025007	25 x 3/4"	A	89	37	23	19	38	120	160
493504032007	32 x 3/4"	A	108	40	25	23	43	96	280
493504032010	32 x 1"	B	123	39	42	27	42	96	280
493504032015	32 x 1 1/2"	A	108	40	25	23	43	96	360
493504040010	40 x 1"	A	117	44	25	29	47	48	535
493504040013	40 x 1 1/4"	A	117	44	25	29	47	48	432
493504040015	40 x 1 1/2"	A	117	44	25	29	47	48	453
493504050015	50 x 1 1/2"	A	133	48	25	38	52	48	560
493504050020	50 x 2"	A	138	48	30	38	52	40	744
493504063015	63 x 1 1/2"	A	161	57	30	48	59	24	1072
493504063020	63 x 2"	B	193	58	62	49	57	24	959

Male Transition Elbow 45°

492604

Codo de Transición de 45° Macho

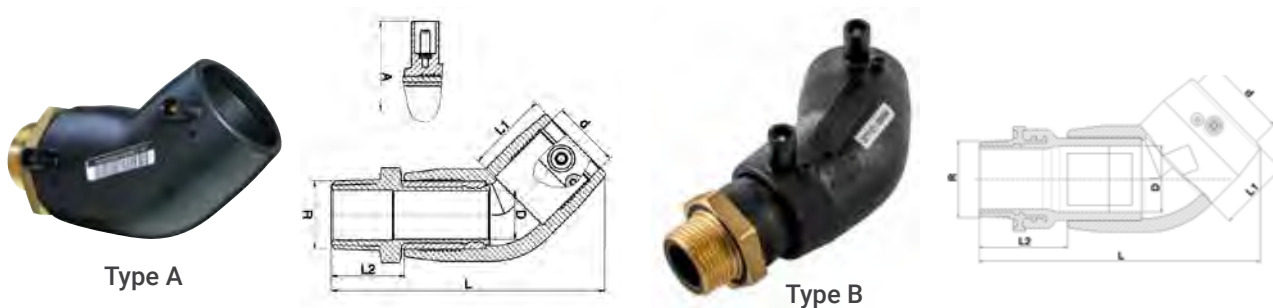

Product Code	Size d x R	Type	L	L1	L2	D	A	UC	W
492604032005	32 x 1/2"	A	124	39	29	23	43	84	249
492604032007	32 x 3/4"	A	123	39	29	23	43	84	250
492604032010	32 x 1"	B	151	39	50	22	42	72	375
492604032013	32 x 1 1/4"	A	130	39	36	23	43	48	479
492604032015	32 x 1 1/2"	A	130	39	36	23	43	48	488
492604040010	40 x 1"	B	158	48	45	22	47	60	433
492604040013	40 x 1 1/4"	B	168	48	55	30	47	60	485
492604040015	40 x 1 1/2"	A	144	44	36	29	47	48	510
492604040020	40 x 2"	A	149	44	41	29	47	40	685
492604050010	50 x 1"	A	161	49	34	38	51	48	564
492604050013	50 x 1 1/4"	A	161	49	36	38	51	48	610
492604050015	50 x 1 1/2"	B	185	49	63	35	52	48	600
492604050020	50 x 2"	A	165	49	41	38	51	30	778
492604063013	63 x 1 1/4"	A	184	57	36	48	59	24	927
492604063015	63 x 1 1/2"	A	184	57	36	48	59	24	893
492604063020	63 x 2"	B	215	58	68	47	57	24	953
492604075020	75 x 2"	A	221	71	41	59	62	16	1399
492604075025	75 x 2 1/2"	A	226	71	46	59	62	16	1600

Female Transition Elbow 45°

493604

Codo de Transición de 45° Hembra



Product Code	Size d x Rp	Type	L	L1	L2	D	A	UC	W
493604032007	32 x 3/4"	A	120	39	25	23	43	—	320
493604032010	32 x 1"	B	141	44	40	27	42	72	342
493604032015	32 x 1 1/2"	A	120	39	25	23	43	72	488
493604040010	40 x 1"	A	133	44	25	29	47	48	510
493604040013	40 x 1 1/4"	A	133	44	25	29	47	48	419
493604040015	40 x 1 1/2"	A	133	44	25	29	47	48	479
493604050015	50 x 1 1/2"	A	150	49	25	38	51	48	532
493604050020	50 x 2"	A	155	49	30	38	51	36	702
493604063015	63 x 1 1/2"	A	178	57	30	48	59	24	1019
493604063020	63 x 2"	B	208	58	62	49	57	24	912

Female Free Nut Transition Coupler*

494104

Enlace de Transición, Tuerca Libre, Hembra



Product Code	Size d x G	L	L1	L2	D	A	UC	W
494104020007	20 x 3/4"	106	37	30	14	34	200	160
494104025007	25 x 3/4"	112	40	30	14	37	140	150
494104025010	25 x 1"	115	40	33	19	37	140	200
494104032007	32 x 3/4"	100	39	20	14	42	100	164
494104032010	32 x 1"	124	42	36	19	42	100	260
494104032013	32 x 1 1/4"	124	42	36	23	42	78	310
494104040010	40 x 1"	115	44	25	19	47	100	278
494104040013	40 x 1 1/4"	113	44	23	23	47	52	320
494104040015	40 x 1 1/2"	135	47	38	29	45	52	444
494104050010	50 x 1"	136	49	36	19	52	32	700
494104050013	50 x 1 1/4"	120	49	23	23	52	70	371
494104050015	50 x 1 1/2"	123	49	25	29	52	32	484
494104050020	50 x 2"	141	49	41	38	52	32	709
494104063020	63 x 2"	161	57	44	38	57	28	770
494104063025	63 x 2 1/2"	166	57	49	48	57	20	1154

* May be converted into male free nut by addition of a threaded nipple.

* Se puede convertir en la tuerca loca macho mediante la adición de un niple roscado.

Female Free Nut Transition Elbow 90°*

494504

Codo de Transición de 90° Tuerca Libre, Hembra

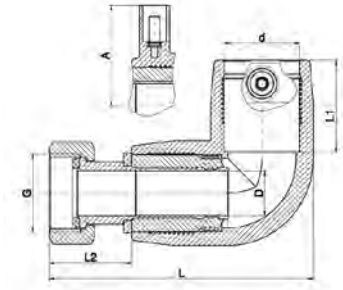

Product Code	Size d x G	L	L1	L2	D	A	UC	W
494504020007	20 x 3/4"	96	35	30	14	38	140	164
494504025007	25 x 3/4"	96	37	30	14	38	140	164
494504025010	25 x 1"	99	37	33	19	38	105	164
494504032010	32 x 1"	119	40	36	19	43	70	164
494504032013	32 x 1 1/4"	119	40	36	23	43	70	324
494504040015	40 x 1 1/2"	132	44	40	29	47	48	490
494504050020	50 x 2"	149	48	41	38	52	30	779
494504063020	63 x 2"	175	57	44	41	59	16	1024
494504063025	63 x 2 1/2"	180	57	49	48	59	16	1245

* May be converted into male free nut by addition of a threaded nipple.

* Se puede convertir en la tuerca loca macho mediante la adición de un niple roscado.

Female Free Nut Transition Elbow 45°*

494604

Codo de Transición de 45° Tuerca Libre, Hembra

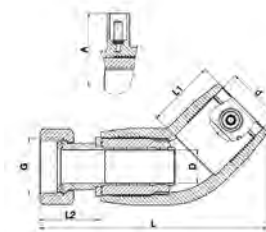

Product Code	Size d x G	L	L1	L2	D	A	UC	W
494604032010	32 x 1"	131	39	36	19	43	70	164
494604032013	32 x 1 1/4"	129	39	34	23	47	56	400
494604040015	40 x 1 1/2"	146	44	38	29	47	48	469
494604050020	50 x 2"	166	49	41	38	51	30	740
494604063020	63 x 2"	189	57	41	38	59	24	164
494604063025	63 x 2 1/2"	197	57	44	48	59	16	1184

* May be converted into male free nut by addition of a threaded nipple.

* Se puede convertir en la tuerca loca macho mediante la adición de un niple roscado.

Female Union Free Nut Transition Tee

494404

Enlace T, PE/Latón, Tuerca Libre, Hembra

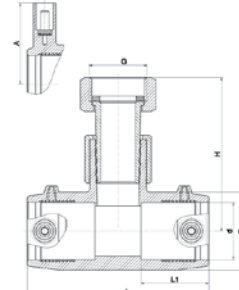

Product Code	Size d x G	L	L1	D	H	A	UC	W
494404032010	32 x 1"	104	39	44	88	43	50	320

PE Male Transition Coupler

497104

Enlace de Transición PE Macho

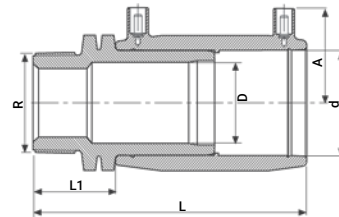

Product Code	Size d x R	L	L1	D	A	UC	W
497104020005	20 x 1/2"	97	21	14	34	200	129
497104025007	25 x 3/4"	113	31	18	37	200	61
497104032010	32 x 1"	123	35	24	42	200	92
497104040010	40 x 1"	134	37	30	46	128	146
497104040013	40 x 1 1/4"	137	40	30	46	128	152
497104040015	40 x 1 1/2"	137	40	30	46	128	159
497104050015	50 x 1 1/2"	141	40	38	51	96	238
497104063015	63 x 1 1/2"	161	44	48	57	40	371
497104063020	63 x 2"	165	48	48	57	40	450

PE Male Transition Elbow 90°

497504

Codo de Transición PE de 90° Macho

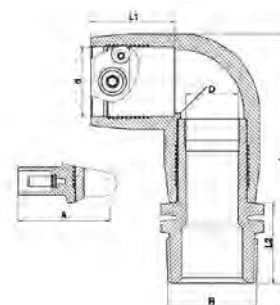

Product Code	Size d x R	L	L1	D	A	L2_Cap	UC	W
497504020005	20 x 1/2"	87	35	14	38	21	160	78
497504025007	25 x 3/4"	97	37	18	38	31	200	75
497504032010	32 x 1"	118	40	24	43	35	96	120
497504040010	40 x 1"	129	44	30	47	37	48	458
497504040013	40 x 1 1/4"	132	44	30	47	40	48	202
497504040015	40 x 1 1/2"	132	44	30	47	40	48	250
497504050015	50 x 1 1/2"	148	48	38	52	40	48	296
497504063015	63 x 1 1/2"	175	57	48	59	44	44	458
497504063020	63 x 2"	179	57	48	59	48	44	490

PE Male Transition Elbow 45°

497604

Codo de Transición PE de 45° Macho

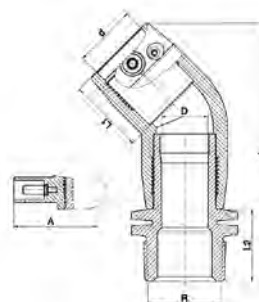

Product Code	Size d x R	L	L1	D	A	L2_Cap	UC	W
497604032010	32 x 1"	141	39	24	43	35	96	150
497604040010	40 x 1"	145	42	30	47	37	96	175
497604040013	40 x 1 1/4"	148	42	30	47	40	96	185
497604040015	40 x 1 1/2"	148	42	30	47	40	96	185
497604050015	50 x 1 1/2"	165	49	38	51	40	48	271
497604063015	63 x 1 1/2"	192	57	48	59	44	24	465
497604063020	63 x 2"	196	57	48	59	48	24	470

PE Cast Iron Flange Transition Coupler

497704

Enlace de Transición Bridado - PE Hierro Fundido

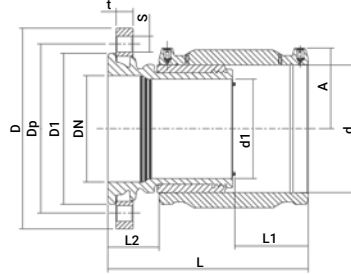

Product Code	Size d x DN	A	L	L1	L2	D1	d1	D	Dp	s	t	No. of holes	UC	W
497704063	63 x 50	57	217	57	100	104	43	165	125	18	20	4	4	4200
497704090	90 x 80	70	216	73	68	139	67	200	160	18	20	8	4	5779
497704110	110 x 100	79	223	80	61	159	84	220	180	18	22	8	4	7280
497704125	125 x 100	87	235	85	62	159	98	220	180	18	22	8	4	7759
497704160	160 x 150	105	268	93	73	215	125	285	240	22	24	8	1	13400
497704180	180 x 150	116	284	105	72	215	140	285	240	22	24	8	1	15246
497704225	225 x 200	138	314	119	74	270	176	340	295	22	26	12	1	23919

PE Cast Iron Spigot Transition Coupler

495704

Enlace de Transición Espiga - PE Hierro Fundido

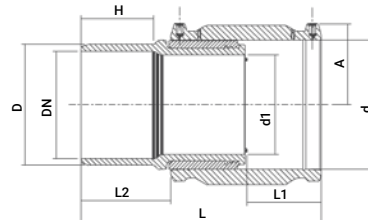

Product Code	Size d x DN	A	L	L1	L2	D	d1	H	UC	W
495704090080	90 x 80	69	254	73	106	98	67	94	8	2874
495704110100	110 x 100	79	275	80	112	118	84	96	4	4170
495704125100	125 x 100	87	280	85	107	118	98	91	4	4569
495704160150	160 x 150	104	322	97	124	170	125	102	2	8105
495704180150	180 x 150	114	339	104	127	170	140	103	2	10121
495704225200	225 x 200	140	372	118	132	222	176	109	1	12284

Full Face Flange

490209

Brida de Cara Plana

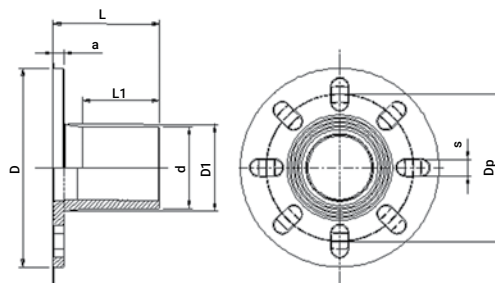

Product Code	Size d	L	L1	D	D1	a	Dp	s	UC	W
490209090	90	118	86	220	98	12	163	20	18	540

Stub Flange

490207

Adaptador de Brida

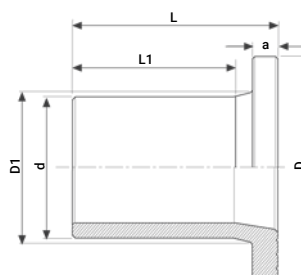

Product Code	Size d	L	L1	a	D	D1	UC	W
490207020	20	85	45	7	45	26	160	26
490207025	25	85	40	9	58	32	160	42
490207032	32	85	60	10	68	40	160	59
490207040	40	85	60	11	78	50	160	84
490207050	50	104	75	12	88	61	144	104
490207063	63	120	87	14	102	75	60	220
490207075	75	130	92	16	122	89	48	322
490207090	90	140	96	17	138	105	32	475
490207110	110	160	110	18	158	125	20	643
490207125	125	182	132	25	158	132	16	945
490207140	140	180	130	25	188	155	12	1245
490207160	160	180	130	25	212	175	8	1600
490207180	180	198	140	30	212	187	4	1990
490207200	200	200	135	32	268	232	4	3100
490207225	225	200	135	32	268	235	4	3360
490207250	250	215	145	35	320	285	3	5080
490207280	280	228	160	35	320	291	2	5688
490207315	315	238	160	35	370	335	1	7785
490207355	355	255	175	40	430	373	1	10400
490207400	400	286	195	45	482	427	1	14970

Flange Backing Ring

09903

Brida Revestida

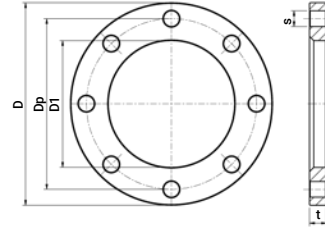

Product Code	Flange Type	Flange (DN)	D	Dp	D1	s	t	No. of Holes	UC	W
09903020	ISO/DIN PN 10/16	20 x 1/2" (DN15)	95	65	28	14	12	4	200	240
09903025	ISO/DIN PN 10/16	25 x 3/4" (DN20)	105	75	34	14	14	4	180	300
09903032	ISO/DIN PN 10/16	32 x 1" (DN25)	115	85	42	14	16	4	150	495
09903040	ISO/DIN PN 10/16	40 x 1 1/4" (DN32)	140	100	51	18	18	4	120	685
09903050	ISO/DIN PN 10/16	50 x 1 1/2" (DN40)	150	110	62	18	18	4	100	812
09903063	ISO/DIN PN 10/16	63 x 2" (DN50)	165	125	78	18	17	4	20	1110
09903075	ISO/DIN PN 10/16	75 x 2 1/2" (DN65)	185	145	92	18	18	4	20	1205
09902095	ISO/DIN PN 10/16	90 x 2 1/2" (DN65)	185	145	102	18	20	8	100	2,552
09903090	ISO/DIN PN 10/16	90 x 3" (DN80)	200	160	108	18	20	8	20	1400
09903110	ISO/DIN PN 10/16	110 x 4" (DN100)	220	180	128	18	20	8	20	1570
09903125	ISO/DIN PN 10/16	125 x 4" (DN100)	220	180	135	18	20	8	40	1470
09903140	ISO/DIN PN 10/16	140 x 5" (DN125)	250	210	158	18	24	8	30	1930
09903160	ISO/DIN PN 10/16	160 x 6" (DN150)	285	240	178	22	24	8	6	3625
09903180	ISO/DIN PN 10/16	180 x 6" (DN150)	285	240	188	22	24	8	10	2150
09903200	ISO/DIN PN 10	200 x 8" (DN200)	340	295	236	22	24	8	4	3600
09903225	ISO/DIN PN 10	225 x 8" (DN200)	340	295	239	22	24	8	8	3510
09903250	ISO/DIN PN 10	250 x 10" (DN250)	395	350	288	22	30	12	8	5200
09901250	BS 10 Table D	250 x 10" BS	395	355	288	22	26	8	1	10,055
09903280	ISO/DIN PN 10	280 x 10" (DN250)	395	350	294	22	30	12	8	5500
09901280	BS 10 Table D	280 x 10" BS	395	355	294	22	26	8	1	10,055
09903315	ISO/DIN PN 10	315 x 12" (DN300)	445	400	338	22	34	12	3	8350
09901315	BS 10 Table D	315 x 12" BS	445	406	338	22	26	12	1	10,055
09903355	ISO/DIN PN 10	355 x 14"	—	460	376	—	39	16	2	20000
09901355	BS 10 Table D	355 x 14" BS	520	470	376	26	28	12	1	10,055

Wastewater System, We Make the Connection

Polyethylene offers the ideal cost-effective and technically superior alternative to other materials, requiring minimal effort to install, reducing the number of connections required and increasing the system lifespan. The PLASSON System constitutes an excellent investment for both public wastewater infrastructures and private wastewater systems

The PLASSON wastewater system offers a strong, long-life and is resistant to axial loads through its special versatile products that can be completely fused after being laid.



Systemas de Aguas Residuales, Hacemos la Conexión

En comparación con otros materiales, el polietileno constituye la alternativa ideal en términos de costo-beneficio y superioridad técnica, ya que requiere un mínimo esfuerzo de instalación, con menos conexiones, y asegura una larga vida útil. El sistema de PLASSON es una inversión excelente, tanto para las infraestructuras públicas de aguas residuales como para los sistemas privados.

Los sistemas de PLASSON para aguas residuales son muy duraderos y resistentes a las cargas axiales, gracias a la versatilidad de sus productos que pueden fusionarse completamente después de la instalación.

Wastewater Adjustable Saddle*

475804

Ramal Para Aguas Residuales*

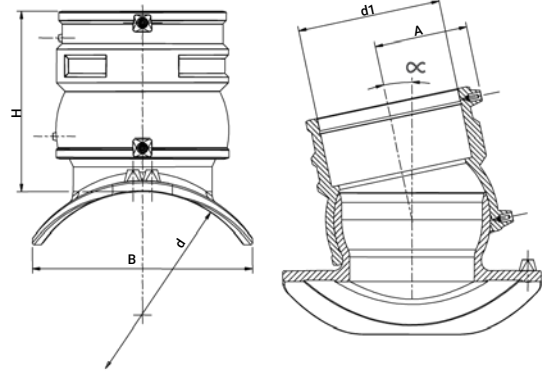

Product Code	Size d x d1	B	H	A	L	UC	W
475804200160	200 x 160	208	202	105	290	4	2050
475804250160	225-250 x 160	225	202	105	290	4	2060
475804315160	280-315 x 160	247	202	105	290	4	2070
475804560160	355-560 x 160	263	202	105	290	4	2080
475804710160	560-710 x 160	277	202	105	290	4	2100

Wastewater Saddle 45° - Inlet 110*

4758A4

Ramal 45° de Salida Para Aguas Residuales*

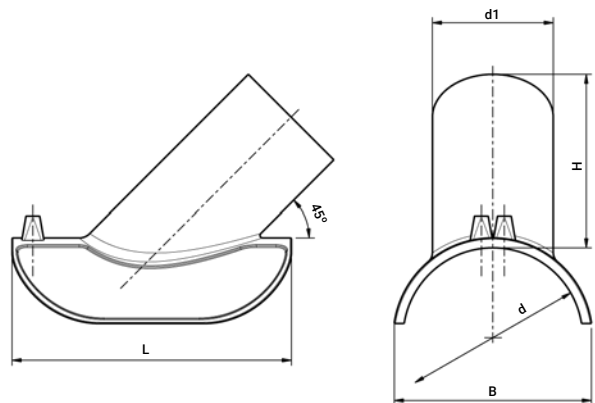

Product Code	Size d x d1	L	B	H	UC	W
4758A4160110	160-200 x 110	255	182	158	10	710
4758A4250110	225-315 x 110	255	221	158	10	656

* See dedicated tools on page 183 | * Ver herramientas necesarias en pag. 183

Wastewater Saddle PVC/PP Adaptor Inlet*

4758V4

Collarín lightfit de transición para aguas residuales de PE A PP/PVC *

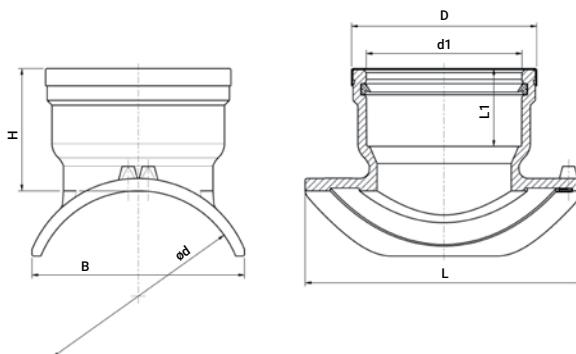

Product Code	Size d x d1	B	H	L	L1	D	UC	W
4758V4200160	200 x 160	208	125	290	80	190	6	1660
4758V4250160	225-250 x 160	225	125	290	80	190	6	1309
4758V4315160	280-315 x 160	245	125	290	80	190	6	1326
4758V4560160	355-560 x 160	263	125	290	80	190	6	1430
4758V4710160	560-710 x 160	277	125	290	80	190	6	1527

Wastewater Saddle Spigot Inlet*

4758S4

Collarín lightfit de transición para aguas residuales de PE /PE*

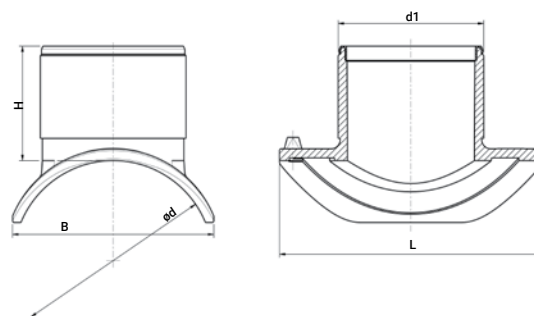

Product Code	Size d x d1	B	H	L	UC	W
4758S4200160	200 x 160	208	125	290	6	1091
4758S4250160	225 - 250 x 160	225	125	290	6	1239
4758S4315160	280 - 315 x 160	247	125	290	6	1260
4758S4560160	355 - 560 x 160	263	125	290	6	1300
4758S4710160	560 - 710 x 160	277	125	290	6	1310

* See dedicated tools on page 183 | * Ver herramientas necesarias en pag. 183

Wastewater Adjustable Elbow One Sided

4747D4

Codo Ajustable Para Aguas Residuales

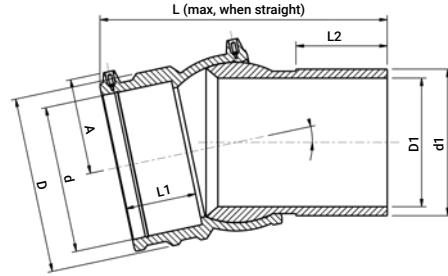

Product Code	size dxd1	SDR	D	D1	L	L1	L2	A	UC	W
4747D4160	160	17	193	141	298	78	98	105	6	3030

Wastewater Manhole Adaptor

37020/477207

Adaptador Para Pozo de Aguas Residuales

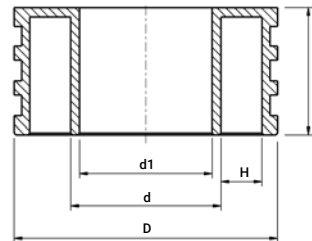

Product Code	Size d	L	d1	D	H	UC	W
37020110	110	135	97	216	37	—	1650
37020125	125	135	111	235	39	—	1800
37020140	140	135	123	254	39	—	1950
477207160	160	135	141	280	39	6	2524
37020180	180	135	157	335	66	4	3550
37020200	200	135	176	355	56	2	3660
477207225	225	135	198	355	44	2	3902
37020250	250	135	220	400	54	2	3740
477207280	280	135	247	400	39	2	5027
37020315	315	135	278	450	46	2	5130
37020355	355	135	313	500	50	2	6480
37020400	400	135	353	560	59	1	8260
37020450	450	135	397	592	50	—	22350
37020500	500	135	441	651	54	—	23600
37020560	560	135	494	705	51	—	34500
37020630	630	135	555	773	50	—	47370

Wastewater PE to PVC Adaptor

4701V4

Adaptador Para PE A PVC

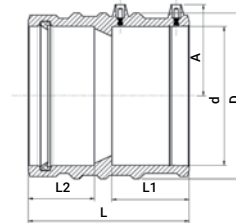

Product Code	Size d	L	L1	L2	D	A	UC	W
4701V4160	160	187	90	77	193	106	6	1546

Wastewater Adjustable Elbow PE to PVC

4747V4

Codo Ajustable de Transición de PE a PVC

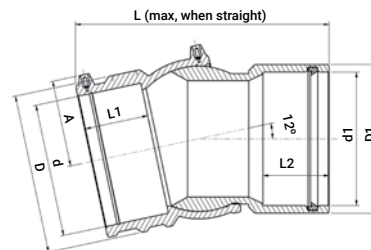

Product Code	Size d x d1	D	D1	L	L1	L2	A	UC	W
4747V4160	160 x 160	193	180	253	78	80	105	6	2140

Wastewater Elbow 45°

470604

Codo 45° Para Aguas Residuales

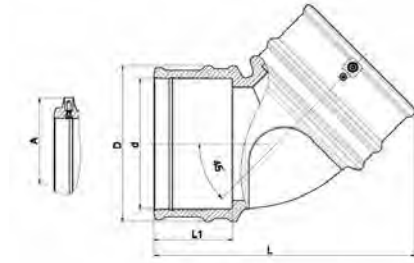

Product Code	Size d	L	L1	D	A	UC	W
470604160	160	325	98	193	106	4	2000

Wastewater Elbow 30°

473304

Codo 30° Para Aguas Residuales

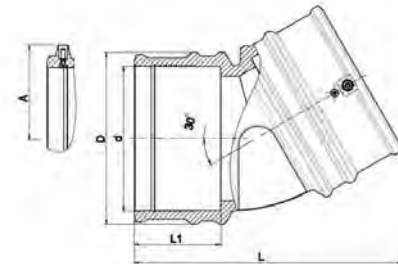

Product Code	Size d	L	L1	D	A	UC	W
473304160	160	302	98	193	106	5	1850

Wastewater Elbow 15°

473704

Codo 15° Para Aguas Residuales

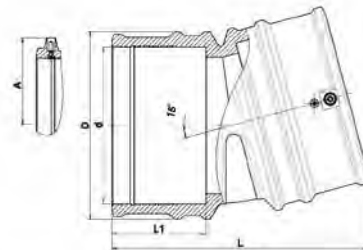

Product Code	Size d	L	L1	D	A	UC	W
473704160	160	267	98	193	106	5	1740

Technical Specifications for PLASSON Electrofusion Fittings

Fitting Pressure Rating and Pipe Compatibility

PLASSON Fittings are weldable to PE80, PE100, PE100-RC and PE-X pipes (most fittings)*.

Check that the pipe SDR is compatible with the PLASSON fittings. The range of compatible pipe SDR's for each specific fitting is defined on the fitting barcode label.

For questions regarding pipe SDR compatibility refer to PLASSON literature or contact your local PLASSON representative.

* Please consult your PLASSON representative

The following is a general guideline for PLASSON EF product pipe SDR compatibility (in any case of discrepancy between the figure below and the figure on the barcode label, always refer to the barcode data).

PLASSON's Electrofusion Fittings:

- PN 16 (Water)
- PE100 SDR11 (Gas)
- Up to 75mm (inclusive) are Weldable to Pipes SDR ≤ 11
- Elbows and Tees of main diameter 40mm-75mm ≤ 17
- 90mm & Up are Weldable to Pipes SDR ≤ 17
- 63-75mm Tapping Saddles and Valves are suitable for SDR11

Note: for tapping SDR ≤ 11 pipes (size 63 and up), please consult your PLASSON representative.

LightFit:

- PN 10 (Water)
- PE100 SDR17 (Gas)
- 40mm - 75mm are Weldable to Pipes SDR ≤ 17
- 90mm are Weldable to Pipes SDR ≤ 26
- 110mm - 710mm are Weldable to Pipes SDR ≤ 33
- 800mm and up are weldable to pipes SDR≤41

Wastewater Saddle

- PN 0.5 (Water)
- 200mm & Up are Weldable to Pipes SDR ≤ 26

Wastewater Adjustable Elbow

- PN 0.5 (Water)
- 160mm is Weldable to Pipes SDR ≤ 17

Measure the pipe external diameter toward the pipe end using a Pi tape. The pipe external diameter must be within the tolerances defined in International standards such as ISO 4437-2, AS/NZS, 4130, EN 1555-2 and EN 12201-2.

Material

All PLASSON electrofusion fittings are produced from material class PE100 which conform to international standards for potable water and natural or suitable manufactured gas systems.

Standards

PLASSON electrofusion fittings are designed, tested and quality controlled according to PLASSON's internal standards. These standards are based on the following international standards:

- EN 1555
- EN 12201
- NF 136
- AS/NZS 4129
- WIS 4-32-14
- WIS 4-32-15

Quality

PLASSON has incorporated a quality assurance system in accordance with ISO 9001. Operating approval according to ISO 9001 was granted to PLASSON by the Israeli Standard Institute. Operating according to the ISO 9001 quality assurance system imposes stringent standards of control throughout the manufacturing processes.

Abbreviations used on the product description pages of this catalog:

A, A1	Height of shroud from centerline	L, L1, L2	Length
d, d1	Nominal diameter of fitting or outlet	c	Number of bolt holes in flanges
D, D1	Diameter	s	Diameter of bolt holes in flanges
DN	Nominal bore corresponding approximately to the inside diameter of the pipe	t	Thickness of metal flange
Dp	Pitch circle diameter of bolt holes in flanges	W	Weight in grams
G, R, Rp	Threaded outlet diameter	UC	Units per carton
H	Height	Fusion and cooling time are specified on the individual product.	

Whereas the products shown in this catalogue illustrate and describe the current state of their development, PLASSON reserves the right at all times to make such technical alterations as it shall see fit to its products. Although every care has been taken in the preparation of the information, specifications and other data included in this catalogue, we cannot rule out inadvertent errors or omissions. Purchasers should take into account possible deviations or variations which will not substantially diminish the functionality or performance of the products, and, in many cases, are designed to improve the same.

PLASSON® is the Registered Trademark of PLASSON Ltd. or PLASSON Maagan Michael Industries Ltd. PLASSON's products are protected by patents, trademark, design and copyright laws.

Especificaciones técnicas para los accesorios ElectroFusión de PLASSON

Presiones nominales y compatibilidad con la tubería

Los accesorios electrofusión de PLASSON se pueden soldar a tuberías de materiales PE80, PE100, PE100-RC, PE-X (la mayoría de los accesorios)*

Por favor revise que el SDR de la tubería es compatible con el rango declarado en el código de barras del accesorio PLASSON. Cada accesorio PLASSON contiene esta información.

Nota: para obtener más información sobre SDR de tuberías vea la información del fabricante de la tubería a soldar y literatura de PLASSON. Ante cualquier duda consulte a su representante de PLASSON

A continuación una guía general sobre la compatibilidad de accesorios PLASSON según el SDR del tubo a electrofundar. (En caso de existir alguna discrepancia por favor proceda según indica la calcomanía del accesorio que contiene el código de barras).

Presiones nominales

Las presiones nominales de todos los accesorios electrofusión de PLASSON son las siguientes:

- PN 16 (Agua)
- MOP10 (Gas)

Accesorios de ElectroFusión de PLASSON

- Hasta 75mm (inclusive), soldables en tuberías SDR ≤ 11
- Codos y Tes en diámetros 40mm – 75mm ≤ 17
- De 90mm en adelante soldables en tuberías SDR ≤ 11
- De 63-75mm Tomas en carga y Válvulas soldables en tuberías SDR 11

NOTA: Para tuberías SDR ≤ 11 (diámetro desde 63mm hacia arriba) consulte a su representante de PLASSON.

LightFit:

- PN10 (Agua)
- PE100 SDR 17 (GAS)
- 40mm - 75mm soldables en tuberías SDR ≤ 17
- 90mm soldables en tuberías SDR ≤ 26
- 110mm - 800mm soldables en tuberías SDR ≤ 33

Ramales de ElectroFusión PLASSON para aguas residuales

- PN 0.5 (Agua)
- De 200mm en adelante en tuberías SDR ≤ 26

Codos ajustables de ElectroFusión para aguas residuales

- PN 0.5 (Agua)
- De 160mm en adelante en tuberías SDR ≤ 17

Para medir el diámetro externo de una tubería utilice una cinta PI. El diámetro externo debe estar contemplado dentro de las tolerancias estipuladas en las normas internacionales ISO 4437-2, AS/NZS.

Material

Todos los accesorios ElectroFusión de PLASSON se fabrican con material de clase PE100, de conformidad con las normas internacionales para sistemas de agua potable y gas natural o procesado. Accesorios de PE80, disponibles a petición del cliente.

Normativa

El diseño, las pruebas y el control de calidad de los accesorios electrofusión de PLASSON se llevan a cabo de acuerdo con las normas internas de PLASSON, basadas en las siguientes normativas internacionales:

- EN 1555
- EN 12201
- NF 136
- AS/NZS 4129
- WIS 4-32-14
- WIS 4-32-15

Aseguramiento de Calidad

PLASSON utiliza el sistema de aseguramiento de calidad conforme a la normativa ISO 9001. La certificación de la empresa de acuerdo con ISO 9001 le fue otorgada a PLASSON por el Instituto Israelí de Normas Industriales. La operación conforme a la normativa de aseguramiento de calidad ISO 9001 impone estrictos procedimientos de control durante todos los procesos de fabricación.

Abreviaturas utilizadas en la descripción de productos de este catálogo:

A, A1	Altura desde la línea central a la cubierta del resistor	L, L1, L2	Longitud
d, d1	Diámetro nominal del accesorio o salida	c	Número de orificios en las bridas
D, D1	Diámetro	s	Diámetro de los orificios p/tornillos en las bridas
DN	Diámetro nominal interno, correspondiente aproximadamente al diámetro interno del tubo	t	Grosor de la brida metálica
Dp	Diámetro de los orificios en las bridas	W	Peso en gramos
G, R, Rp	Diámetro de la salida roscada	UC	Cantidad por caja de cartón
H	Altura	Los tiempos de soldadura y enfriamiento se indican en cada producto.	

Si bien en este catálogo se ilustran y describen los productos en el estado actual de su desarrollo, PLASSON se reserva el derecho de introducir en cualquier momento las modificaciones técnicas que considere convenientes.

La preparación de la información, especificaciones y otros datos se ha hecho con el mayor cuidado, no obstante lo cual no podemos asegurar que estén libres de errores u omisiones involuntarios. El cliente debe tener en cuenta la posibilidad de desviaciones o variaciones que no afectarán significativamente el funcionamiento o rendimiento de los productos y que, en muchos casos, están destinadas a mejorarlos.

PLASSON™ es la marca registrada de PLASSON Ltd. o PLASSON Maagan Michael Industries Ltd.
Los productos de PLASSON están protegidos por derechos de patente, marcas comerciales, diseño y leyes de copyright.



The logo consists of a red square containing a white icon of a pipe with a joint, followed by the word "PLASSON" in white, uppercase, sans-serif font.

PLASSON

ELECTROFUSION TOOLING

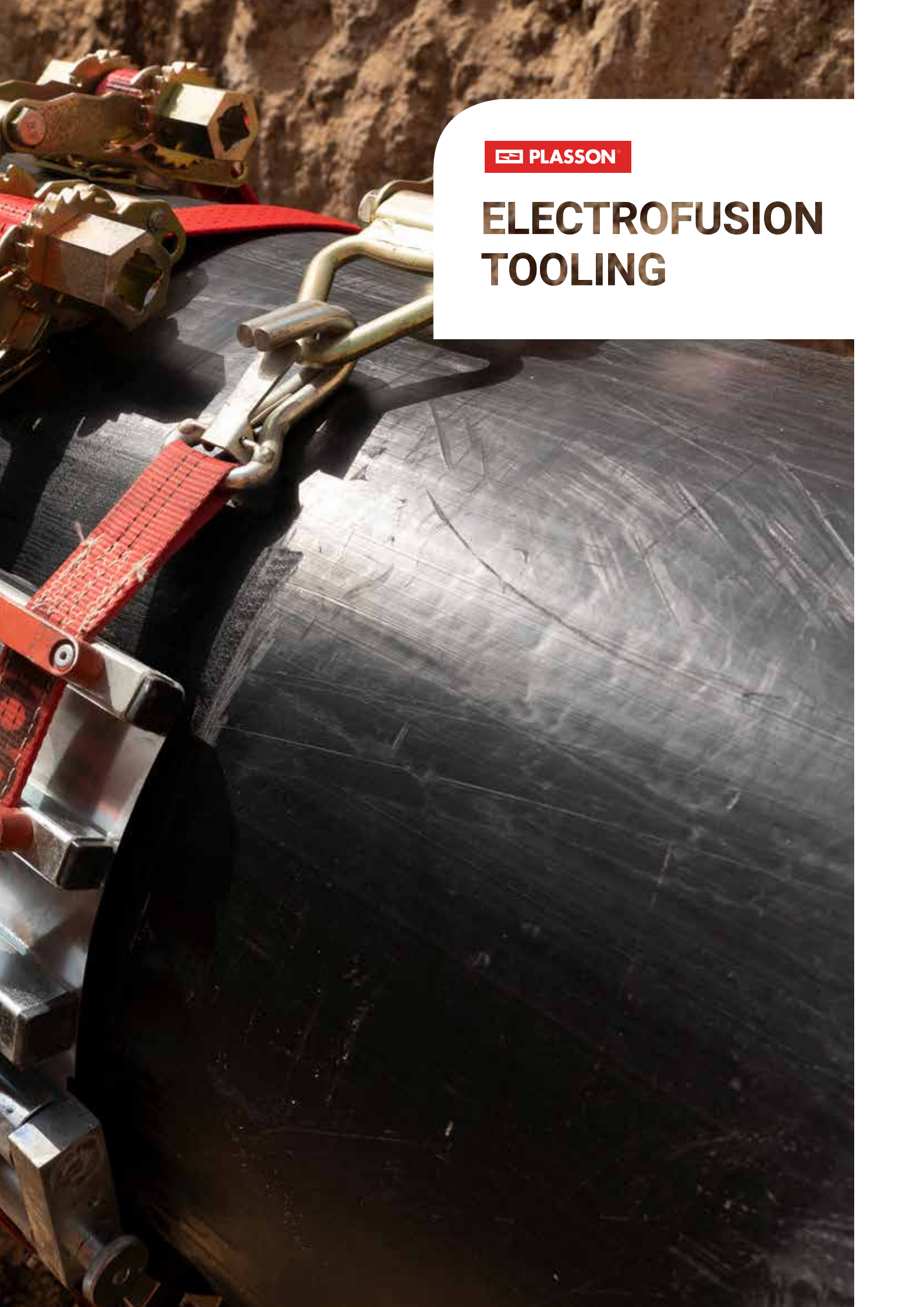

Content

Electrofusion Tooling - Herramientas Para Electrofusión

Pipe Preparation - Preparación de la tubería	168
What is PLASSON SMARTFUSE? - Que es PLASSON SMARTFUSE	170
Control Boxes - Controladores Electrofusión	173
Control Boxes Cont. - Características	174
Electrofusion Control Boxes & Accessories - Accesorios para controladores Electrofusión	176
Pipe Cutting - Cortadores de tuberías	177
Pipe Peeling - Rascadores de tuberías	178
Rerounding Tools - Redondeadores	180
Squeeze Off Tools - Prensas / Obturadores	181
Pipe Cleaning - Limpiadores de tubería	182
Pipe Clamping - Sujetadores	182
Specialized Installation Tooling For PLASSON Products - Sujetadores para la instalación de productos PLASSON	183
Large Bore Saddles Installation Tools - Sujetadores para la instalación de tomas simples/bridadas de gran diámetro / Ramales PLASSON	184
Tools for Drilling - Herramientas para perforación de tomas simples/bridadas de gran diámetro / Ramales PLASSON	186
Hot Tapping Tools - Herramientas para tomas en carga de grandes diámetros	186

PF-Schweißtechnologie GmbH (PFS)

PLASSON'S range of electrofusion tooling is designed and manufactured by our joint venture partner, PFS. Founded in 1997 in Germany, PFS quickly developed into one of the world's leading manufacturers of plastic welding technologies for pipeline construction. The product range includes a wide variety of electrofusion control units, butt fusion machines, extensive accessories and a complete portfolio of tools for the preparation of plastic pipes for welding.



High Quality Products

Thousands of customers around the globe rely on the high quality of PFS products.

Product development is conducted by employees with many years of experience, know-how, dedication and with a high capacity to innovate.

Close cooperation with end users of PFS products and systems provides real field feedback to allow refinement of products, even at component level, resulting in products robust enough to handle even the most difficult site conditions.



Turn your PLASSON Control Box into the ultimate welding machine with our **new Smartphone App**.



Available now

Features of the Free Upgrade

- ✓ **Smartphone control** of your box, with no mobile network coverage needed
- ✓ **Improved quality control** with guided welding process and photo capture of crucial steps (kept with the weld record)
- ✓ **Data recording** including physical location of each weld
- ✓ Ability to **identify installer** of each weld
- ✓ Ability to **weld all fittings***



Smarter plumbing
with PLASSON.



*Monomatic Control Boxes will be limited to emergency welds of other fittings



Pipe Preparation | Preparación de la tubería

Pipe preparation is the basis of the electrofusion process.

The pipe preparation includes few simple yet important steps described below:

Cutting of the pipe:

The pipe ends must be cut square and even.

Various approved pipe cutting tools



1. Rotational pipe cutter



2. Pipe cutter



3. Rotational pipe cutter (S-type)

Marking and scraping:

In order to achieve a good weld the oxide layer of the pipe must first be removed.

Mechanical peeling tools are strongly preferred, as they achieve a consistent pipe surface preparation

Hand scraper

When using hand scrapers - perform long even scrapes starting from outside the marked areas to avoid "cratering" in the fusion zone of the fitting until all marks are removed.

Rotational scraper

One scraping pass is to be carried out in order to remove approx. 0.2 to 0.3 mm of the outer pipe surface. If the pipe diameter is still too large, additional scraping may be performed in order to facilitate insertion, as long as the average pipe diameter is kept above minimum.

This is the preferred peeling method as it will remove the pipe surface evenly.

Rotational Scraper / Hand scraper



1. Rotational scraper



2. Hand scraper



3. Do not touch the scraped area with bare hands after scraping and cleaning

Pipe rounding:

Electrofusion fittings are designed to work on a round pipe.
Do not perform an electrofusion weld if the pipe does not meet the criteria defined below at the section where the EF fitting is to be welded.
Use a pipe re-rounder if necessary to correct pipe ovality.

For pipe DN < 315

$d1 - d2 < 1.5\% \text{ DN or } < 3\text{mm}$ (whichever is the smallest value.)

For pipe DN \geq 315

$d1 - d2 < 1\% \text{ DN or } < 5\text{mm}$ (whichever is the smallest value.)

It is extremely important to re-round the pipe

prior to the welding process.

In order to do so, measure the pipe diameter with a suitable measuring tool to find the maximum and minimum diameter points and calculate the difference between these diameters.

Pipe ovality (out of roundness) = $d1 - d2$

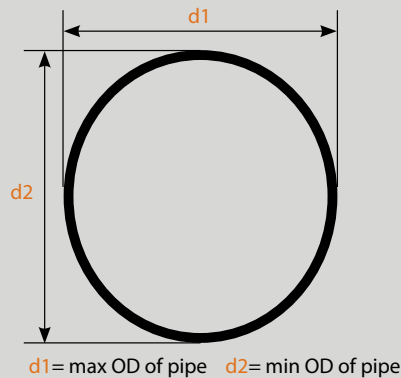

Clamping and alignment (fitting restraint):

Pipe movement during welding and cooling cycles might occur as well as sources of stress and strain that can be applied on the pipe/fitting assembly.

All electrofusion socket fittings (regardless of the manufacturer) must be clamped to the pipes in order to eliminate all mechanical stress in the welding zone.

Example of clamping and alignment device



1. Misaligned pipes



2. Example of clamping and alignment device

PLASSON SmartFuse Electrofusion System

What Is PLASSON SmartFuse?

SmartFuse is PLASSON's smart welding recognition system. By using a compatible PFS electrofusion controller, this system enables a simple identification of the electrofusion fittings to be welded and their welding time. Connecting the controller red cable to the red terminal pin initiates the identification. The controller reads the value of the resistor located in the red terminal pin and allocates the nominated welding time. All that is left for the operator to do is compare the welding time shown on the controller screen to that on the barcode label and press the "start" button on the controller to start the welding process! Simple, safe and reliable.

How Is This Done?

PLASSON electrofusion fittings are designed in a way that enables a single weld time in an ambient temperature range of -10°C up to +45°C. The weld energy will adjust "automatically" as function of the ambient temperature due to the metal coil electrical resistance which will change. At lower temperatures the coil resistance will decrease, resulting in higher energy applied to the weld, while at higher temperatures the energy will decrease.

No Temperature Compensation

Other fittings in the market compensate for the change in ambient temperature by changing the welding time, a system called temperature compensation. Temperature compensation is achieved by a specially defined barcode label, which instructs the welding controller to increase or decrease the weld time as function of the ambient temperature measured by the controller. Such system relies on the legibility of the barcode, and an assumption that the temperature at the point at which it is read is identical to that at the pipe/fitting interface, which is not always the case. If the weld is performed without a barcode reading EF controller, the operator will need to estimate the temperature on site, read the temperature compensation tables correctly (if supplied and legible) and enter the new weld time into the controller. Such process relies on operator skill/judgment and as such, is open to human error.

Electrofusion Control Unit

PF control boxes dynamically monitor the weld process when used with PLASSON ElectroFusion fittings.

- Dynamic monitoring - By continually monitoring the weld current, an electrofusion Control Unit will shut down if the current increases above the dynamic tolerance range, thereby avoiding the overheating and anti-oxidant depletion of PE materials which can adversely affect long-term weld integrity.
- Generator variability tolerance - PF control boxes are tolerant to generator variability as they accept a large voltage range and frequency variation.
- Numerous servicing centres for PF welding equipment are available.

What can go wrong?

Without dynamic monitoring of a PLASSON Automatic Welding electrofusion Control Unit, faults may occur unnoticed during the weld process causing the fitting to fail once in general use. Common causes of this can be seen in the diagram below.

Typical Electrofusion Welding Faults

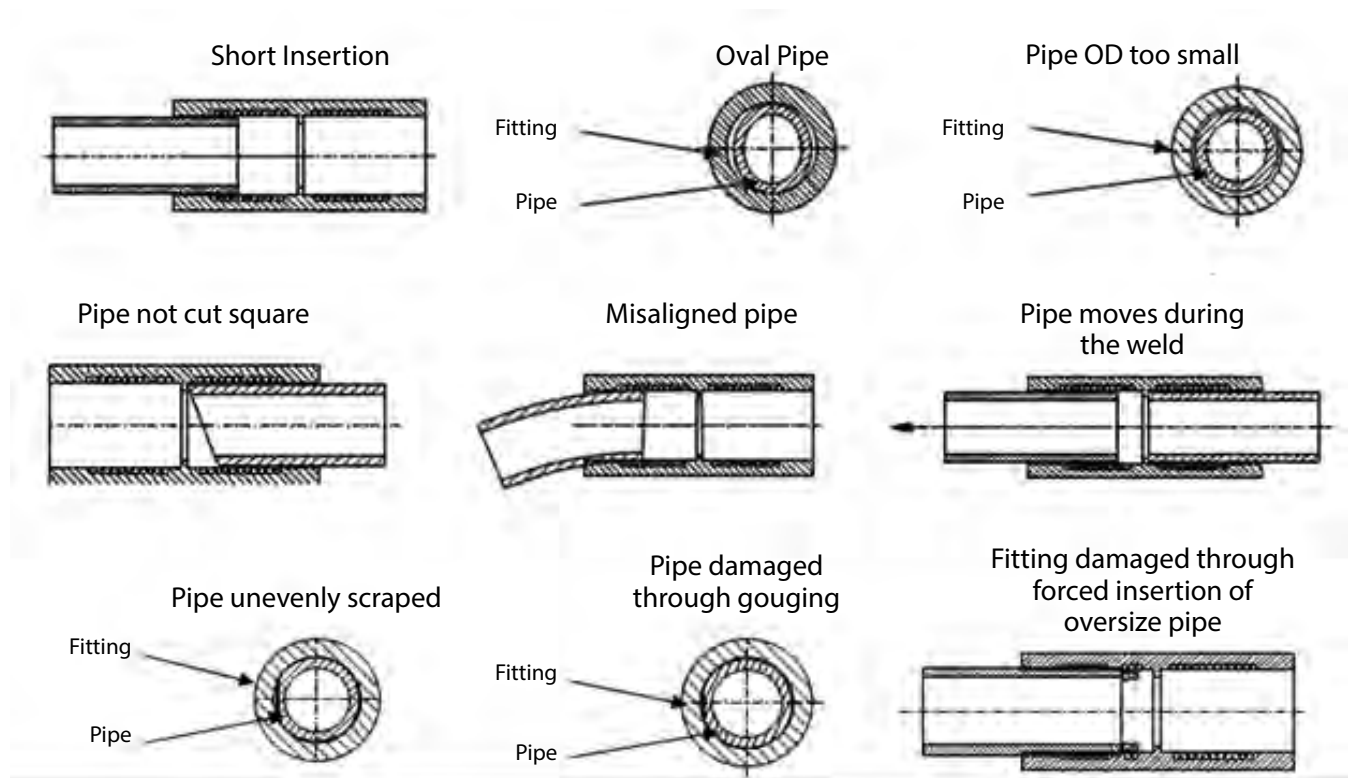

Please note:

PLASSON Automatic electrofusion Control Unit will not carry out this dynamic monitoring process on other manufacturers' fittings.



POLYCODE

New **lighter** and **smaller** SmartFuse control box

- ✓ Welds PLASSON fittings
- ✓ Light < 14kg
- ✓ Compact (470 x 370 x 180mm)
- ✓ Bluetooth enabled for smartphones using PLASSON SmartFuse App
- ✓ Use App to automatically determine and record welding parameters
- ✓ 10 amp plug
- ✓ Tough weather-proof carry case



Control Boxes | Controladores Electrofusión

Control Box Comparison Table

Features	POLYCODE	Mononmatic Data	PF Polymatic Plus USB	PF PolyControl Plus V2.0
3M Lead	29143.03085324			
5M Lead		29143.0307.000	29143.0307.303	29143.F0318V112
Fitting size	up to 180mm	up to 355mm	up to 800mm (sizes above 355mm require cooling between welds)	Any size, continuous welding, no cooling
Welds	Any EF fittings	PLASSON only (competitor allowance with App)	Any EF fittings	Any EF fittings
Weld Tip Size	4.0mm Universal	4.0mm Universal	4.0mm Universal	4.0mm Universal
Bluetooth	Y	Y	Y	Y
PLASSON SmartFuse Mode (Automatic)	Y	Y	Y	Y
Manual Input of Welding Time	N	N	Y	Y
Welding Voltage	8-48 V	39.5V	8-48V	8-48V
Output Current (Maximum)	75A (54A)	60A (80A)	80A (110A)	90A (105A)
Data recording	Y	Y with app	Y	Y
Multilingual Display Messages	Y	Y	Y	Y
Error messages in plain text	Y	Y	Y	Y
Adjustable display contrast	Y	Y	Y	Y
Dynamic process supervision	Y	Y	Y	Y
Auto software check	Y	Y	Y	Y
Resistance check	Y	Y	Y	Y
Ramped start	Y	Y	Y	Y
Service Message	After 200 Hours or 12 Months	After 200 Hours or 12 Months	After 200 Hours or 12 Months	After 200 Hours or 12 Months
Barcode reading capability	Y with app	Y with app	Y	Y
Fitting and Operator traceability	Y with app	Y with app	Y	Y
Earth Pin	10A	15A	15A	15A
Active Cooling	N	N	N	Y

The electrofusion control units made by PF Schweißtechnologie GmbH provide the following features to increase the generator suitability:

- High tolerance for the input voltage
 - 190V to 300V at 230V nominal
 - 90V to 150V at 110V nominal
- High tolerance for the input frequency
 - 40Hz to 70Hz
- Display of current input voltage and frequency.
- Soft-Start for limitation of the generator load.

Despite these characteristics, the used generators must meet the following requirements and recommendations, in order to avoid damage to the electrofusion control unit.

This ensures that the internal monitoring functions of the control unit do not interrupt the welding process:

- Suitable for phase-angle control
- 230 V
 - No-load voltage adjustable between 240 V and 260 V
 - Output current of 18 A on one phase
 - For PolyControl: Better 21 A on one phase
- 110 V
 - No-load voltage adjustable between 120 V and 130 V
 - Output current of 36 A on one phase
- Stable output voltage and engine RPM even with rapidly changing load
- Synchronous generators with mechanical RPM control preferred
- Voltage peaks must not exceed 800 V



Extension lines

When using extension cables, it is essential that you also observe the information on the required conductor cross-sections and the maximum length. If you use cable drums, you must unwind them completely.

Control Boxes Cont. | Características

Monomatic Data USB BT



Attention!

For welding of couplers in with a welding time of 900 s a stable and continuous supply voltage of 230 V is mandatory. When using a generator, it must be set to a no load voltage of between 240 V and 260 V.

The electrofusion control units of type Monomatic, Monomatic (Bluetooth), Monomatic Data USB and Monomatic Data USB (Bluetooth) can only be used together with SmartFuse-capable fittings and couplers. Only couplers that have a welding time of 900 s or below can be welded.

Welding time of the fittings	Recommended generator output power
20 to 600 s	3.2 kW
750 to 900 s	4.5 kW (mechanically controlled) 5.0 kW (electronically controlled)
> 900 s	Not possible to weld
Extension cord	Conductor cross-section
Up to 30 m	3 × 1.5 mm ²
Up to 50 m	3 × 2.5 mm ² (for the entire length)



Polymatic Plus USB BT

Variants: All

Usage for dimensions from **20 to 630 mm** without limitation.

When working with dimensions from 630 mm on, longer cool-down times must be provided for because otherwise the device might show the "Device too hot" error message. In this case, it is necessary to let the electrofusion control unit cool down before putting it to use again.

Dimension range of fittings	Recommended generator output power
20 to 160 mm	3.2 kW
180 to 500 mm	4.5 kW (mechanically controlled) 5.0 kW (electronically controlled)
> 500 mm	6.5 kW (mechanically controlled) 7.5 kW (electronically controlled)
Extension cord	Conductor cross-section
Up to 30 m	3 × 1.5 mm ²
Up to 50 m	3 × 2.5 mm ² (for the entire length)



Control Boxes Cont. | Características

PolyControl Plus V2.0 BT

Variants: All

Suitable without restriction for all coupler dimensions resp. PKS-systems that have a maximum continuous current consumption of **up to 85 A.**



Fan failure!

If the fan on the back side of the electrofusion control unit is not running, the dimension range is reduced to the following sizes: up to 250 mm without limit. 280-400 mm with cool down phases.

You should not use the controller without a running fan for dimensions larger than 400 mm to avoid damaging the device.

Dimension range of fittings	Recommended generator output power
20 to 160 mm	3.2 kW
180 to 500 mm	4.5 kW (mechanically controlled) 5.0 kW (electronically controlled)
> 500 mm	6.5 kW (mechanically controlled) 7.5 kW (electronically controlled)
Extension cord	Conductor cross-section
Up to 30 m	3 × 2.5 mm ²
Up to 50 m	3 × 4.0 mm ² (for the entire length)



PolyCode USB BT

Variants: All



Attention!

For welding of couplers in 180 mm a stable and continuous supply voltage of 230 V is mandatory. When using a generator, it must be set to a no load voltage of between 240 V and 260 V.

Dimension of coupler	Requirements
020-125 mm	Usable without restrictions.
125-180 mm	Longer cool-down times must be provided for because otherwise the device might show the "Device too hot" error message. In this case, it is necessary to let the electrofusion control unit cool down before putting it to use again.
180 mm (SmartFuse)	Only couplers that have a welding time of 400 s or below can be welded.
180 mm (Barcode)	Only couplers that have a resistance of >0.6 Ω can be welded.
> 180 mm	Couplers >180 mm cannot be welded.

Before processing fittings in this dimension range, you have to check that the welding current demand of the fitting does not continuously exceed the output current of the device and that the maximum output current is not exceeded.

Dimension range of fittings	Recommended generator output power
20 to 75 mm	2 kW
90 to 160/180 mm	4 kW
Extension cord	Conductor cross-section
Up to 50 m	3 × 1.5 mm ²



Electrofusion Control Boxes & Accessories | Accesorios para controladores Electrofusión

		Code
POLYCODE	3m Fixed lead	29143.0308S324
Monomatic	5m Lead	29143.0307.000
Polymatic plus USB	5M Lead	29143.0307.103
PolyControl Plus V2	5M Lead	29143.F0318V112



Welding Cables For Monomatic Or Digimatic Universal	Code
5M Detachable Lead with universal terminals	29142.0610.032
10M Detachable Lead with universal terminals	29142.0611.005



Welding Cables For Polymatic Plus Usb With Universal (Reading Pen Sold Separately)	Code
5M Detachable Lead with 4.0 mm terminals	29142.0610.014
10M Detachable Lead with 4.0 mm terminals	29142.0611.016/1

Smartfuse Adaptors - 29142.0200.006



Reading Pens	Code
Reading Pen 2DL	29142.0100.001
Barcode Scanner Touch ID	29142.0120.004
Barcode Scanner Touch ID for PolyCode	29142.0120.003

Transport Case	Code
Transport Case (Monomatic/ Digimatic/ Polymatic Plus)	29141.2800.005

Ruling And Marking	Code
Magnetic Circular Pipe Ruler	29144.4402.001
Pi-Meter 20-700mm with Vernier 0.1mm	29145.5003.001
Pi-Meter 20-1200mm with Vernier 0.1mm	29145.5003.000

Marking Pens	Code
Marking pens broad white	29145.3100.019



Pipe Cutting | Cortadores de tuberías

Secateur Pipe Cutter	Code
Pipe Cutter up to 63mm (Single Hand)	29145.3000.007
Pipe Cutter Spare Blade for 63mm (Single Hand)	29145.3000.008
Pipe Cutter up to 63mm (Two Hand Use)	29145.3000.001

Rotational Pipe Cutter (S-Type)	Code
Rotational Pipe Cutter - 20 - 75mm	29145.3001.004
Rotational Pipe Cutter Spare Blade 20-75mm	29145.3001.005
Rotational Pipe Cutter 50 - 140mm	29145.3001.001
Rotational Pipe Cutter 90 - 160mm	29145.3001.002
Spare Blade 140 / 160mm	29145.3001.003

Rotational Pipe Cutter	Code
Rotational Pipe Cutter 32-125mm	29144.4400.006 ■
Rotational Pipe Cutter 90-315mm	29144.4400.005 ■
Rotational Pipe Cutter 63-225mm	29144.4400.004 ■

Rotary Circular Saws 230 V	Code
250-500mm (Max. Cutting Depth 65mm)	29144.4401.002 ■
500-1200mm (Max. Cutting Depth 85mm)	29144.4401.001 ■
180-400 mm (Max. Cutting Depth 38mm)	29144.4401.005 ■



Pipe Peeling | Rascadores de tuberías

Hand Scraper	Code
Hand Scraper - Small 1 1/2"	29145.3002.001
Blades for Small Hand Scraper (2)	29145.3002.002
Hand Scraper - Large 2 1/2"	29145.3002.003
Blades for Large Hand Scraper (2)	29145.3002.004



Rotational Peeling Tool Peeling for Saddle and Coupler Installation	Code
Rotational Peeling Tool 16-40mm	29144.4200.000/1
Rotational Peeling Tool 20-63mm	29144.4200.001 ■
Rotational Peeling Tool 20-125mm	29144.4200.031 ■
Rotational Peeling Tool 90-315mm	29144.4200.033 ■
Rotational Peeling Tool 63-225mm	29144.4200.032 ■



U-Peeler Peeling for Saddle and Coupler Installation	Code
U-Peeler 63mm	29144.4800.063 ■
U-Peeler 75mm	29144.4800.075 ■
U-Peeler 90mm	29144.4800.090 ■
U-Peeler 110mm	29144.4800.110 ■
U-Peeler 125mm	29144.4800.125 ■
U-Peeler 140mm	29144.4800.140 ■
U-Peeler 160mm	29144.4800.160 ■
U-Peeler 180mm	29144.4800.180 ■
U-Peeler 200mm	29144.4800.200 ■
U-Peeler 225mm	29144.4800.225 ■



Pipe End Peeler Tool	Code
Pipe End Scraper Tool 63-200mm	29144.4200.015 ■
Pipe End Scraper Tool 90-315mm	29144.4200.027 ■
Pipe End Scraper Tool 180-400mm	29144.4200.016 ■



Mechanical Rotational End Peeler Tool Battery Powered	Code
PLASSON Scraper Tool For Pipe Ends 25-75mm Incl. Cordless Drill BOSCH in Plastic Suitcase	29144.4200S101 ■



Chain Peelers Peeling for Saddle and Coupler Installation	Code
Chain Peeler 110-400mm	29144.4200.013 ■
Chain Peeler 250-450mm	29144.4200.007 ■
Chain Peeler 250-800mm	29144.4200.009
Extension 900-1000mm for Rotational	29144.4200.010
Chain Peeler 400-800mm 230 V	29144.4200.036 ■
Extension 900-1000mm for Electrical Chain Peeler	29144.4200.038 ■
Chain Peeler 800-1200mm 230 V	29144.4200.037
Extension 1400-1600mm for Electrical Chain Peeler	29144.4200.039

Powered Scrapers	Code
Electrical Saddle Scraper (110V)	29144.4200.025 ■
Electrical Saddle Scraper (230V)	29144.4200.024 ■
Electrical Saddle Scraper Cordless (230V)	29144.4200.026



Battery Powered Chain Peeler

- ✓ Reduce pipe peeling time by almost 75%
- ✓ A new battery powered solution for the fast, more efficient and reliable preparation of large bore PE pipe for electrofusion welding.
- ✓ For use on 400-800mm pipe, with an optional extension kit to 1000mm, the PLASSON replaces hand powered tools to remove the oxidised and contaminated outer layer on PE pipe by peeling a consistent 0.2-0.3mm layer from the pipe surface. A version for pipe 800-1200mm is also available. It can be extended to 1600 mm by the optional extension kit.
- ✓ The chain peeler is designed to work with challenges of ovality, flatness and varying pipe wall thickness, resulting in very large reductions in coupler handling times.
- ✓ Supplied with two quick charge batteries.



Rerounding Tools | Redondeadores | Two required - one rounding tool for each side of fitting.

Rerounding Clamp 32-63mm	Code
32-40mm	29144.4602.006
50-63mm	29144.4602.007

Rerounding Clamp 63-400mm	Code
63-180mm	29144.4602.005
110-250mm	29144.4602.003
180-315mm	29144.4602.004
250-400mm	29144.4602.009

Rounding Pliers	Code
32-40mm	29144.4602.016
50-63mm	29144.4602.015

Rerounding Rings 63-250mm	Code
63mm	29145.3006.063
75mm	29145.3006.075
90mm	29145.3006.090
110mm	29145.3006.110
125mm	29145.3006.125
140mm	29145.3006.140
160mm	29145.3006.160
180mm	29145.3006.180
200mm	29145.3006.200
225mm	29145.3006.225
250mm	29145.3006.251

Hydraulic Rounding Shell 315-400mm	Code
Hydraulic Jack (315-400)	29145.3008.013
Rounding Shell 315mm (without jack)	29145.3008.001
Rounding Shell 355mm (without jack)	29145.3008.002
Rounding Shell 400mm (without jack)	29145.3008.003

Hydraulic Rounding Shell 450-630mm	Code
Hydraulic Jack (450-630)	29145.3008.014
Rounding Shell 450mm (without jack)	29145.3008.004
Rounding Shell 500mm (without jack)	29145.3008.005
Rounding Shell 560mm (without jack)	29145.3008.006
Rounding Shell 630mm (without jack)	29145.3008.007

Hydraulic Rounding Shell 710-900mm	Code
Hydraulic Jack (710-900)	29145.3008.015
Rounding Shell 710mm (without jack)	29145.3008.008
Rounding Shell 800mm (without jack)	29145.3008.009
Rounding Shell 900mm (without jack)	29145.3008.010

Hydraulic Strap Rounder	Code
450-710mm	29144.4602.017
Extension 800-1200mm	29144.4602.018
450-1200mm	29144.4602.019

* Hydraulic Tool. Use with PE pipes 450-800mm (Max. SDR 11)

Mechanical Rounding Tool 450-800mm	Code
450-560mm	29144.4602.013
630-710mm	29144.4602.014



Rerounding Shell 315-900mm



Mechanical Rounding Tool 450-800mm

Rerounding Tools Cont.

Rerounding Shell 63-225mm	Code
Used to round pipe after squeezing	
63mm	29145.3005.063 ■
75mm	29145.3005.075 ■
90mm	29145.3005.090 ■
110mm	29145.3005.110 ■
125mm	29145.3005.125
140mm	29145.3005.140
160mm	29145.3005.160
180mm	29145.3005.180
200mm	29145.3005.200
225mm	29145.3005.225



Squeeze Off Tools | Prensas / Obturadores

Manual Squeeze Off Tool For Gas Pipes	Code
16-32mm (wall 3mm) nad 40mm SDR11	29144.4100.013 ■
Manual Squeeze Off Tool	Code
20-63mm Suits SDR11 16/20,25,32,40,50,63mm & SDR17 63mm Squeeze off is affected by turning the handle in a clockwise direction.	29144.4100.010 ■
Hydraulic Squeeze Off Tool	Code
63-90mm Suits 63-200mm SDR 11 & 17. Sizes: 63,75,90mm. Hydraulic operation. Metric limit plates set at 1.6t. Safety stops to prevent creep. Springs return jack to park position after squeeze off. Integral safety valve.	29144.4100.006
63-180mm Suits 63-180mm SDR 11 & 17. Sizes: 63,75,90,110,125,160,180mm. Hydraulic operation. Metric limit plates set at 1.6t. Safety stops to prevent creep. Springs return jack to park position after squeeze off. Integral safety valve.	29144.4100.005 ■
63-200mm (Excl. 140mm) Suits 63-200mm SDR 11 & 17 (incl. 2 complete stopper sets). Sizes: 63,75,90,110,125,160,180 and 200mm. Hydraulic operation. Metric limit plates set at 1.6t. Safety stops to prevent creep.	29144.4100.011
75-200mm Suits 75-200mm SDR 11 & 17. Sizes:75,90,110,125,160,180 and 200mm. Hydraulic operation. Metric limit plates set at 1.6t. Safety stops to prevent creep. Springs return jack to park position after squeeze off. Integral safety valve. Springs return jack to park position after squeeze off. Integral safety valve.	29144.4100.007 ■



Pipe Cleaning | Limpiadores de tubería

Cleaning Pads	Code
Tangit Detergent, 1 Liter	29145.2000.001
100 cleaning pads with tangit	29145.2000.002

PLASSON Pipewipes ensure surfaces are clean before electrofusion jointing (scraping of pipe surface is still required). 120 sheets per canister.



Pipe Clamping | Sujetadores

Alignment Clamps	Code
<p>Pipe Clamp 16-63mm Adjustable to suit couplers, reducers, 22.5° 45° & 90° elbows and tees. Promotes restraint during the electrofusion process. Infinitely variable grip clamps to suit any combination of sizes, 16-63mm. Quick tightening operation, lightweight & easy to use.</p>	29144.4300.000
<p>Pipe Clamp 32-110mm Adjustable to suit couplers, reducers, 22.5° 45° & 90° elbows and tees. Promotes restraint during the electrofusion process. Infinitely variable grip clamps to suit any combination of sizes, 32-110mm. Quick tightening operation, lightweight & easy to use.</p>	29144.4300.001
<p>Pipe Clamp 63-225mm Adjustable to suit couplers, reducers, 22.5° 45° & 90° elbows and tees. Promotes restraint during the electrofusion process. Infinitely variable grip clamps to suit any combination of sizes, 110-225mm. Quick tightening operation, lightweight & easy to use.</p>	29144.4300.009
Strap Clamps	Code
<p>Used to prevent movement during the weld process. The PLASSON Strap Clamp, a convenient, flexible system for holding PE pipes steady during the electrofusion process. Does not assist with rerounding. For larger dimensions it is recommended to combine two or more Pipe Clamps (Strap Clamp).</p>	
<p>Strap Clamp 110-560mm 4 pipe clamps, 2 base bars, angled adaptor 22.5°, 45°, 90° & 180°</p>	29144.4300.023
<p>Ball Joint Single Ball Joint</p>	29144.4301.001
<p>Double Ball Joint</p>	29144.4301.002
<p>Strap Clamp 250-800mm With 2 fixed clamps, 2 clamps required</p>	29144.4300.021
<p>Strap Clamp 250-800mm Set Included in set: 2 complete clamps each with a pulling clamp, a fixed clamp and pulling shoes for couplers. Allows you to pull the coupler over the pipe and the opposite pipe into the coupler to complete the insertion.</p>	29144.4300.026
<p>Pipe Support Pipe support to 225mm</p>	29144.4601.003

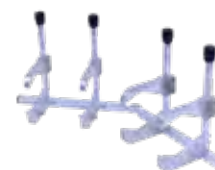
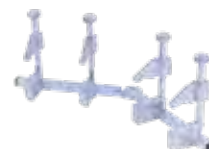
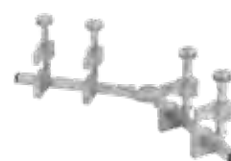

Specialized Installation Tooling For PLASSON Products | Sujetadores para la instalación de productos PLASSON

Waste Water Saddle Installation Tools	Code
Waste Water Clamping & Cutting Tool Set 110 110mm X 45Deg fixed outlet saddle clamp kit. Mains pipe sizes DN160-DN315 Includes: - Saddle clamp unit - Coupon removal tool. Drill not included.	29144.4703.001 ■
Tool for Waste Water Saddle 160 160mm Flexible Outlet Saddle Clamp Kit. Main pipe sizes DN225-DN560 Includes: - Saddle clamp unit - Core drill kit	29144.4700.001 ■



Tension belt for Flex Restraint	Code
Flex Restraint installation clamp (160-1200)	29144.4704.002



Clamping Tool For Sensor Adaptor	Code
Clamping Tool For Sensor Adaptor DN110-DN1200	29144.4706K000
Clamping Tool For Sensor Adaptor DN110-DN1200 without strap	29144.4706K001



Sujetadores para la instalación de tomas

Large Bore Saddles Installation Tools | Sujetadores para la instalación de tomas simples/bridadas de gran diámetro / Ramales PLASSON

To install a PLASSON Large Bore Saddle the following are required:

1. A Clamp Kit to suit the outlet size of the saddle.
2. A Strap Kit for outlet sizes DN200 - DN400.
3. A Core Cutter to core the saddle after welding.
4. A Drill/Motor to operate the Core Cutter.

Clamp Kits	Code
Saddle outlets DN90 - DN160 Includes: <ul style="list-style-type: none"> - Splittable Plates: DN90, 110, 125 & 160 - Pressure Test Spigot Removal Tool - Straps - Rounding Ring - Transport Case 	29144.4701.003 ■
Saddle outlet DN200/DN180 - Includes: <ul style="list-style-type: none"> - Splittable Plate: DN200/DN180 - Rounding Ring - Transport Case - Strap kit required 	29144.4701.201 ■
Saddle outlet DN225/DN250 - Includes: <ul style="list-style-type: none"> - Splittable Plate: DN250 - Rounding Ring - Transport Case - Strap kit required - Rerounding adaptor required for DN225 201 2043 	29144.4701.251 ■
Saddle outlet DN 315/DN 280 - Includes: <ul style="list-style-type: none"> - Splittable Plate: DN 315/DN 280 - Transport Case - Strap kit required - Pressing plate 	29144.4701.315
Saddle outlet DN 400/DN355 - Includes: <ul style="list-style-type: none"> - Splittable Plate: DN 400/DN355 - Transport Case - Strap kit required - pressing plate 	29144.4701.400



Strap Kit	Code
Suitcase with straps and ratchets for PLASSON saddle clamp for xl, xxl plates outlets 180-400, pipes 315-1200: <ul style="list-style-type: none"> - 3x Straps - 3x Ratchets - Torque wrench - Pressure Test Spigot Removal Tool - Transport Case 	29144.4701.009



Rounding Adaptor	Code
DN250 to DN225 Rerounding Adaptor - Use with clamp kit	29141.4701.058

Support Bar	Code
Support Bar for Large Bore Repair Saddle DN250 – DN900 Use in conjunction with DN160 Saddle Outlet Kit	29142.4701.071



Saddle Pressing Tool	Code
Pressing Tool 225mm/SDR17 for lightFit Saddle	29142.4701.066



Saddle Clamping Tool	Code
Clamping Plate 225mm/SDR17 Splittable, for LightFit Saddle	29142.4701.226

Large Bore Saddles Installation Tools Cont.

Core Cutters	Code
Saddle outlet DN90 - DN160 - Includes: 1x 2" 1x DN90 core cutter 1x DN110 core cutter 1x DN125 core cutter 1x DN160 core cutter 1x Centre Drill 1x Drill chuck connector 1x Connector for SDS-Plus 1x Transport Case	29144.4702.003
Saddle outlet DN180, SDR11 DN180 Core Cutter, Borehole 143mm Includes Drill Adaptor and Case	29144.4702.143
Saddle outlet DN200, SDR11 DN200 Core Cutter, Borehole 159mm Includes Drill Adaptor and Case	29144.4702.159
Saddle outlet DN225, SDR11 DN225 Core Cutter, Borehole 179mm Includes Drill Adaptor and Case	29144.4702.179
Saddle outlet DN250, SDR11 DN250 Core Cutter, Borehole 199mm Includes Drill Adaptor and Case	29144.4702.199
Saddle outlet DN315, SDR11 DN315 Core Cutter, Borehole 251mm Includes Drill Adaptor and Case	29144.4702.251
Saddle outlet DN355, SDR11 DN355 Core Cutter, Borehole 283mm Includes Drill Adaptor and Case	29144.4702.283
Saddle outlet DN400, SDR11 DN400 Core Cutter, Borehole 319mm Includes Drill Adaptor and Case	29144.4702.319



Pressure Test Pump	Code
Pressure test pump with adapter for PLASSON large bore saddles	29144.4701.005

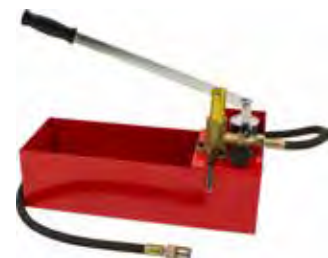

Tools for Drilling | Herramientas para perforación de tomas simples/bridadas de gran diámetro/Ramales PLASSON

Saddles with outlets DN90 – DN225 use a hand operated drill.

Saddles with a DN250 outlet can use either a hand operated drill or a motor mounting clamp and motor.

Saddles with outlets DN315 - DN400 use a motor mounting clamp and motor.

The same motor can be used on all outlets.

Drills - Motor	Code
DN90 - DN250 Outlets. BE75-X3 Quick	29144.4702.999

Saddle Drilling Equipment	Code
---------------------------	------

A complete tool consists of: Basic kit, clamping ring and core cutter.
So, the user must choose the components he needs when he orders.

Basic Kit	29144.4702.911
Clamping Ring 250mm	29142.4702.030
Clamping Ring 280mm	29142.4702.035
Clamping Ring 315mm	29142.4702.029
Clamping Ring 355mm	29142.4702.034
Clamping Ring 400mm	29142.4702.028
Core cutter 250mm SDR11	29141.4704P199
Core cutter 280mm SDR11	29141.4704P233
Core cutter 315mm SDR11	29141.4704P251
Core cutter 355mm SDR11	29141.4704P283
Core cutter 400mm SDR11	29141.4704P319



Hot Tapping Tool | Herramientas para tomas en carga de grandes diámetros

Hot Tapping	Code
Core cutter 250mm	29141.4704P199
Core cutter 280mm	29141.4704P233
Core cutter 315mm	29141.4704P251
Core cutter 355mm	29141.4704P283
Core cutter 400mm	29141.4704P319
Hot Tapping Tool ISO Flange DN150 with 230V Motor	29144.4705.001
Hot Tapping Tool ISO Flange DN150 with 110V Motor	29144.4705.002
Hot Tapping Tool ISO Flange DN150 with 230V Hydraulic Motor excluding hydraulic pump	29144.4705.H001
Hydraulic Pump with Gasoline Engine	29142.4705.300

The tools consists of Motor, Pressure compartment, an Adapter (if necessary) and a core cutter. All components must be ordered separately:

PN16 Compartment DN150	29142.4705.001
PN16 Compartment DN200	29142.4705.006
PN16 Compartment DN250	29142.4705.002
PN16 Compartment DN300	29142.4705.007
PN16 Compartment DN400	29142.4705.004
Adapter DN150 -> DN100	29142.4705.100
Adapter DN150 -> DN80	29142.4705.101



Hot Tapping Tool for Large Bore Saddles

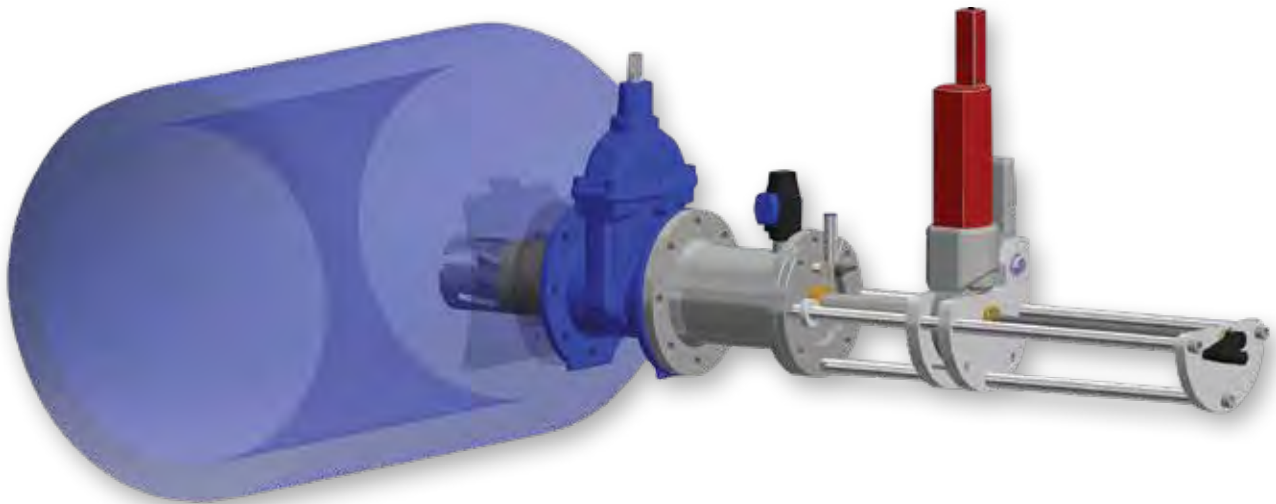

Contact PLASSON for more information



Take good care of your PLASSON control box



It is recommended that control boxes are serviced every 12 months or 200 hours of operation

Frequent servicing of your control box reduces the risk of operational problems interrupting the work flow and costing you money.

A standard service includes:

- Recalibration
- Installation of latest software
- Inspection and testing of all components
- Calibration Certificate

E-mail: sales@PLASSON.com www.flowsolutions.PLASSON.com





The logo consists of a red square containing a white icon of a document with a checkmark, followed by the word "PLASSON" in white, uppercase, sans-serif font.

PLASSON

SERIES 1 FITTINGS

PLASSON Series 1

PLASSON Series 1 - The range of innovative fittings created by PLASSON, market leader in design and manufacture of reliable fittings for polyethylene pipe systems.

PLASSON Series 1 - Fittings provide dedicated solutions for connecting PE pipe to various other pipe materials, such as Copper, Polybutylene, PVC and PEX.

PLASSON Series 1 - Push fittings are designed to withstand 16 bar pressure rating. Inserting the pipe up to the fitting stop creates both the seal and the grip on the pipe.

PLASSON Series 1 - Compact and attractive design makes this fitting ideal for the plumbing market, where space is limited and appearance is crucial. Simplicity of assembly makes both the professional and occasional user's job easier while retaining the PLASSON reliability.

The combination of PLASSON's current fitting range and the new Series 1 fulfill the requirements of all markets for PE pipe connections and connections to other pipe materials.

PLASSON Series 1 features and benefits include:

- Aesthetically designed product - gives a professional finish to the job
- Assembly tools not required - simple push fit assembly
- Compact size - can be assembled in confined spaces
- Instant seal and integrity of joint - captive seal and no nuts to tighten
- Full end load performance - no need to restrain joints
- Transition from PE to internal plumbing systems - Copper, PB, PVC and PEX accommodated in one fitting
- 50 year design life - provides total reliability
- Tamper resistant design - ensures system integrity
- Reduced stock shelf space

Technical Specifications

Materials

Compression Fittings

Body: Polypropylene, high grade copolymer

Nut: High Grade Polypropylene

Split Ring and Grip Ring: Acetal (POM)

Liner: Acetal (POM)

Seal: Nitrile rubber (NBR)

Reinforcing Ring: Stainless steel on all female offtakes from 1 1/4" up to 2"

Threaded Fittings

Body: Polypropylene, high grade copolymer

Reinforcing Ring: Stainless steel

Brass Threads: CW617

Operating Temperatures

The fittings are not to be used with hot water, although they withstand the same temperature as the polyethylene pipe itself.

The fittings will withstand sub-zero temperatures.

Chemical Resistance

PLASSON fittings are supplied, as standard, with polyacetal split and grip rings and NBR seals which are suitable for water.

Operating Pressures and Quality Certificates

PLASSON fittings sizes 20-63 are tested and approved for water according to ISO 17885 (replaced 14236) to PN16.

Threads

Threads marked "R", "Rp" and "Rc" are according to ISO 7-1.

Threads marked "G" are according to ISO 228.

Legend

UB	Units per bag
UC	Units per carton
W	Weight in grams

The units per bag in this catalogue are the default figures, other figures might be applicable to certain markets.

Note

Before installation, ensure that the end of the pipe to be inserted into the fitting is free of scratches and other imperfections and that both the pipe and the fitting itself are free of sand, mud, stones, etc. If fittings are reused, ensure that split ring and grip ring teeth are sharp and bite into the pipe, to avoid pullouts. If uncertain, replace the split ring and grip ring.

Pull out resistance of PVC Adaptors and Universal Adaptors has been approved by pressure testing UPVC/PP pipe assemblies at 25 bar operating pressure for at least 1 hour.

Note: We strongly recommend the use of PTFE tape in threaded connections.

For diameters 40mm and above, chamfering and lubrication of the pipe end will ease insertion (use silicone lubricant).

PLASSON Series 1

100100

Page 200 | Coupler



176100

Page 200 | Universal Slip Repair Coupler



176100/1761Q0

Page 200 | Slip Repair Coupler



101100

Page 201 | Reducing Coupler



101200

Page 201 | End Plug



100200

Page 202 | Male Adaptor



100300

Page 202 | Female Adaptor



1003G0

Page 203 | Female Adaptor G Thread



1001C0

Page 203 | Copper Pipe Adaptor



1002C7

Page 203 | Copper Pipe Male Adaptor



1003C7

Page 204 | Female Copper Adaptor



10017U

Page 204 | Universal Adaptor



1001Q0

Page 204 | PE to PVC Pipe Adaptor



1001QQ

Page 205 | Coupling for PVC Pipe



1001M6

Page 205 | Coupler Metric to Imperial (IPS)



107200

Page 206 | Male Adaptor with Threaded Brass Offtake



1072G0

Page 206 | Male Adaptor with Threaded Brass "G" Offtake



107300

Page 207 | Female Adaptor with Threaded Brass Offtake



1073G0

Page 207 | Female Adaptor with Threaded G* Brass Offtake



1073F0

Page 208 | Female Brass Free Nut Transition



100400

Page 208 | 90° Tee



103400

Page 209 | 90° Reducing Tee



101400

Page 209 | 90° Tee with Threaded Female Offtake



100500

Page 210 | 90° Elbow



100600

Page 210 | 45° Elbow



107500

Page 211 | Wall Plate Elbow



105100

Page 211 | 90° Reducing Elbow



1005M6

Page 212 | 90° Elbow Metric to Imperial (IPS)



108500

Page 212 | 90° Elbow with Threaded Male Offtake



104500

Page 213 | 45° Elbow with Threaded Male Offtake



101500

Page 213 | 90° Elbow with Threaded Female Offtake



107700

Page 214 | 90° Elbow with Threaded Brass Male Offtake



107600

Page 214 | 90° Elbow with Threaded Brass Female Offtake



1076F0

Page 215 | 90° Elbow Female Brass Free Nut Transition



037100

Page 217 | PA Ball Valve Series 1 x Series 1



0371002

Page 217 | PA Ball Valve Series 1 x Male



0371003

Page 218 | PA Ball Valve Series 1 x Female



0371016

Page 218 | PA Ball Valve Series 1 x Free Nut



034100

Page 218 | Compression Stoptap



0341C0

Page 219 | Stoptap - Copper Pipe Adaptor



0358916

Page 219 | Free Nut Union for Water Meter



0358917

Page 219 | Free Nut Adaptor with Check Valve



109900

Page 220 | PLASSON Series 1 Wrench



189600

Page 220 | Chamfer Tool for PE Pipes



100040

Page 220 | Nut



100020

Page 221 | NBR O-Ring



10002D

Page 221 | EPDM O-Ring



100029

Page 221 | NBR Shaped Seal



10002D9

Page 222 | EPDM Shaped Seal



100030

Page 222 | Split Ring



100080

Page 222 | Grip Ring



1091Q0

Page 223 | PVC Pipe Adaptor Kit



Page 224 | Installation Instructions

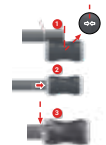

Page 224 | Disassembly

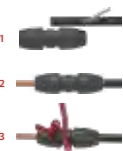

Page 225	Assembly Instructions PVC Pipe Kit	
----------	---------------------------------------	---

Page 226	PLASSON Universal Slip Repair Coupler Assembly Instruction	
----------	--	---

G-PLASS Fittings

150100		
Page 228	Coupler	

151100		
Page 228	Reducing Coupler	

150600		
Page 228	45° Elbow	

150500		
Page 229	90° Elbow	

150400		
Page 229	90° Tee	

153400		
Page 229	90° Reducing Tee	

150200		
Page 230	Male Adaptor	

157200		
Page 230	Male Adaptor with Threaded Brass Offtake	

151200		
Page 230	End Cap Body for Gas	

159511		
Page 231	G-PLASS Liner	

150040		
Page 231	G-PLASS Nut	

150030		
Page 231	G-PLASS Split Ring	

150020		
Page 232	G-PLASS O-Ring/ Shaped Seal	

159900		
Page 232	G-PLASS Wrench	

159900		
Page 232	G-PLASS Integral Chamfer Tool	

Page 233-234	Gplass Installation Instructions	
--------------	-------------------------------------	---



UNIVERSAL SLIP REPAIR COUPLING

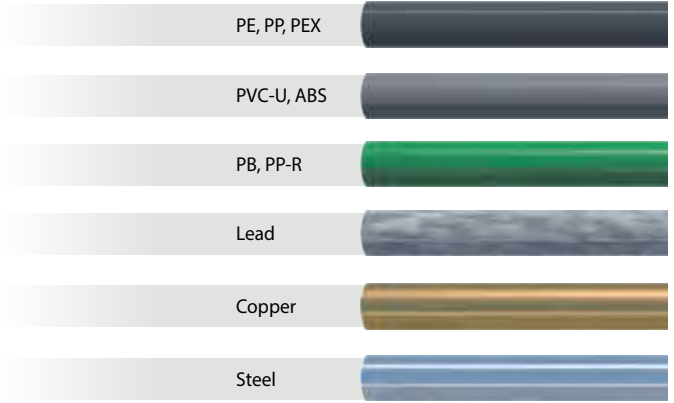

**SLIDE
N'SEAL**



PN16	PN16	PN16	PN16	PN16	PN16	PN16
14-18mm	19-22mm	24-28mm	31-35mm	40-43mm	48-51mm	60-64mm
0.55"-0.71"	0.74"-0.88"	0.94"-1.1"	1.22"-1.37"	1.57"-1.69"	1.89"-2.00"	2.36"-2.52"

TYPICAL PIPES:

25mm	32mm	40mm	50mm	63mm
3/4"	1"	1 1/4"	1 1/2"	2"

Pull-Out Resistant

- Suits a variety of plastic and metal pipe materials
- Each fitting designed to fit a wide range of diameters
- Zero force pipe insertion – can slide freely back and forth
- Thick o-ring seal – compensates for poor pipe quality
- Long sealing area – can bridge over damaged section or gap between pipes
- Total reliability - PN16, 50 year design life



For further information regarding dimensions, suitable pipes and assembly instructions please scan the code.

Coupler

100100

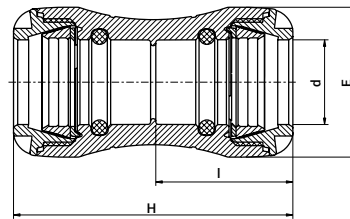

Product Code	Size d	E	H	I	UB	UC	W
100100020	20	41	92	45	1	320	64
100100025	25	47	98	48	1	250	80
100100032	32	58	108	53	1	150	126
100100040	40	70	142	70	1	90	256
100100050	50	85	158	78	1	55	369
100100063	63	103	183	90	1	30	620

Universal Slip Repair Coupler

NEW!

176100

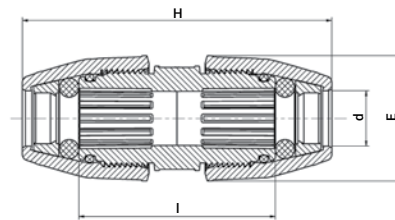

Product Code	Size d	E	H	I	UB	UC	W
176100014018	14-18	54	180	119	1	120	220
176100019022	19-22	58	180	119	1	90	250
176100024028	24-28	66	200	133	1	56	345
176100031035	31-35	76	210	143	1	40	467
176100040043	40-43	89	250	151	1	30	717
176100048051	48-51	101	270	158	1	20	968
176100060064	60-64	120	310	176	1	10	1517

Slip Repair Coupler

176100/1761Q0*

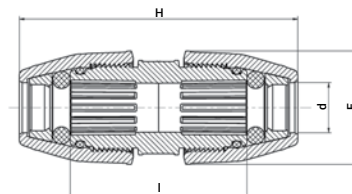

Product Code	Size d	E	H	I	UB	UC	W
1761Q0025	25	60	150	94	5	100	182
1761Q0032	32	68	160	96	5	80	238

* Split ring with metal teeth for wide range of plastic pipes

Reducing Coupler

101100

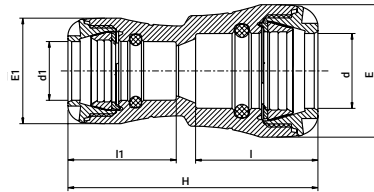

Product Code	Size d x d1	E	H	I	l1	E1	UB	UC	W
101100025020	25 x 20	47	100	48	45	41	1	250	75
101100032020	32 x 20	58	106	54	45	41	1	200	95
101100032025	32 x 25	58	110	54	48	47	1	200	109
101100040025	40 x 25	70	137	71	51	58	1	130	182
101100040032	40 x 32	70	139	71	55	58	1	100	196
101100050025	50 x 25	85	151	79	46	47	1	80	262
101100050032	50 x 32	85	151	79	55	58	1	75	285
101100050040	50 x 40	85	165	77	53	58	1	65	326
101100063032	63 x 32	103	170	91	55	58	1	45	446
101100063040	63 x 40	103	184	91	72	70	1	40	485
101100063050	63 x 50	103	187	91	81	85	1	35	542

End Plug

101200

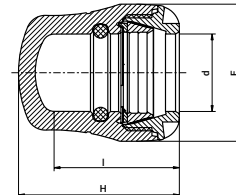

Product Code	Size d	E	H	I	UB	UC	W
101200020	20	41	56	45	1	420	39
101200025	25	47	60	48	1	380	50
101200032	32	58	68	53	1	280	82
101200040	40	70	90	71	1	150	146
101200050	50	85	102	79	1	100	229
101200063	63	103	117	91	1	55	379

Male Adaptor

100200

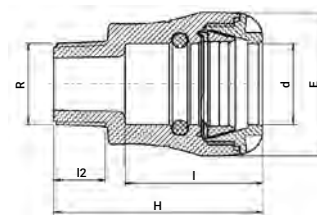

Product Code	Size d x R	E	H	I	I2	UB	UC	W
100200020005	20 x 1/2"	41	70	45	16	1	400	41
100200020007	20 x 3/4"	41	71	45	17	1	380	41
100200025005	25 x 1/2"	47	75	48	16	1	380	52
100200025007	25 x 3/4"	47	76	48	17	1	350	52
100200025010	25 x 1"	47	78	48	19	1	320	55
100200032007	32 x 3/4"	58	82	55	17	1	250	83
100200032010	32 x 1"	58	84	55	19	1	250	86
100200032013	32 x 1 1/4"	58	86	55	21	1	250	90
100200032015	32 x 1 1/2"	58	86	55	21	1	250	94
100200032020	32 x 2"	58	97	55	25	1	180	138
100200040010	40 x 1"	70	104	73	19	1	140	145
100200040013	40 x 1 1/4"	70	106	73	21	1	135	149
100200040015	40 x 1 1/2"	70	106	73	21	1	130	152
100200040020	40 x 2"	70	110	73	25	1	130	161
100200050010	50 x 1"	85	125	78	19	1	90	238
100200050013	50 x 1 1/4"	85	122	78	21	1	90	234
100200050015	50 x 1 1/2"	85	114	81	21	1	90	226
100200050020	50 x 2"	85	118	81	25	1	85	232
100200063015	63 x 1 1/2"	103	125	92	19	1	50	377
100200063020	63 x 2"	103	129	92	25	1	50	367

Female Adaptor

100300

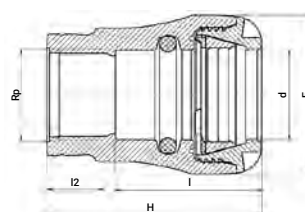

Product Code	Size d x Rp	E	H	I	I2	UB	UC	W
100300020005	20 x 1/2"	41	67	45	17	1	400	43
100300020007	20 x 3/4"	41	71	45	18	1	400	45
100300025005	25 x 1/2"	47	70	48	17	1	380	52
100300025007	25 x 3/4"	47	71	48	18	1	350	52
100300025010	25 x 1"	47	80	48	21	1	350	60
100300032007	32 x 3/4"	58	77	54	18	1	250	78
100300032010	32 x 1"	58	79	54	21	1	250	81
100300032013	32 x 1 1/4"	58	90	54	24	1	200	112
100300032015	32 x 1 1/2"	58	95	54	24	1	140	123
100300040010	40 x 1"	70	97	70	21	1	140	153
100300040013	40 x 1 1/4"	70	100	70	24	1	135	171
100300040015	40 x 1 1/2"	70	103	70	24	1	130	171
100300050013	50 x 1 1/4"	85	110	78	24	1	90	241
100300050015	50 x 1 1/2"	85	110	78	24	1	90	247
100300050020	50 x 2"	85	118	78	29	1	80	252
100300063015	63 x 1 1/2"	103	125	90	24	1	50	378
100300063020	63 x 2"	103	129	90	29	1	45	379

Female Adaptor G Thread

1003G0

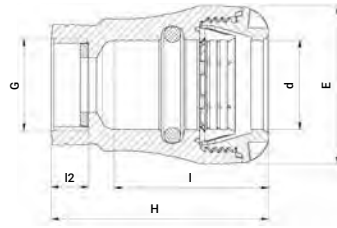

Product Code	Size d x G	E	H	I	I2	UB	UC	W
1003G0025007	25 x 3/4"	47	71	48	12	1	280	53
1003G0025010	25 x 1"	47	80	48	14	1	260	63
1003G0032007	32 x 3/4"	58	76	54	12	1	200	79
1003G0032010	32 x 1"	58	79	54	14	1	200	83
1003G0032013	32 x 1 1/4"	58	90	64	19	1	200	105
1003G0032015	32 x 1 1/2"	64	95	67	19	1	180	105
1003G0040013	40 x 1 1/4"	70	100	74	19	1	135	135
1003G0040015	40 x 1 1/2"	70	103	70	19	1	130	173
1003G0050015	50 x 1 1/2"	85	110	78	19	1	90	252
1003G0050020	50 x 2"	85	118	89	23	1	80	260
1003G0063015	63 x 1 1/2"	103	125	90	19	1	50	260
1003G0063020	63 x 2"	103	129	95	23	1	50	383

Copper Pipe Adaptor

1001C0

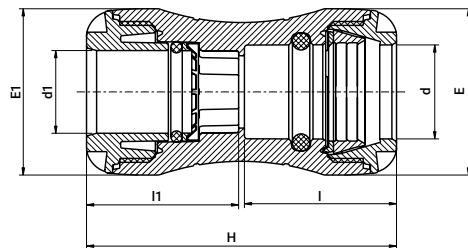

Product Code	Size d x d1	E	H	I	I1	E1	UB	UC	W
1001C0020015	20 x 15	41	92	45	45	41	1	320	68
1001C0025015	25 x 15	47	100	48	46	41	1	250	79
1001C0025022	25 x 22	47	98	48	48	47	1	220	81
1001C0032028	32 x 28	58	108	53	53	58	1	150	131
1001C0040028	40 x 28	70	139	71	55	58	1	100	203

Copper Pipe Male Adaptor

1002C7

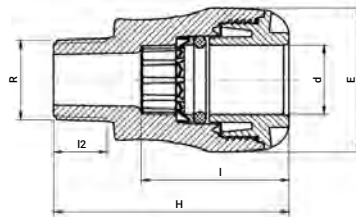

Product Code	Size d x R	E	H	I	I2	UB	UC	W
1002C7015007	15 x 3/4"	41	71	45	17	1	300	47
1002C7022007	22 x 3/4"	47	76	48	17	1	300	51
1002C7028010	28 x 1"	58	84	55	19	1	180	91

Female Copper Adaptor

1003C7

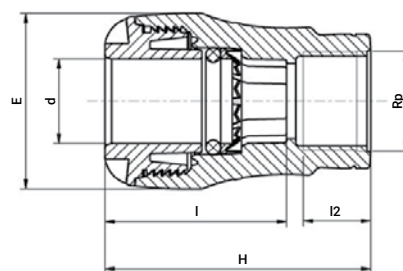

Product Code	Size d x Rp	E	H	I	I2	UB	UC	W
1003C7015007	15 x 3/4"	41	71	45	18	1	300	48
1003C7022007	22 x 3/4"	47	71	48	18	1	280	55

Universal Adaptor

10017U

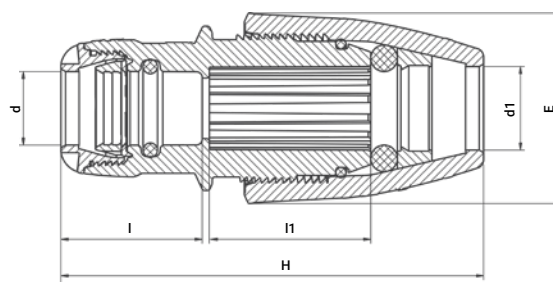

Product Code	Size d x d1	E	H	I	I1	UB	UC	W
10017U025018	25 x 14-18	54	117-137	48	47	5	180	130
10017U025022	25 x 19-22	57	119-130	48	47	5	150	141
10017U025028	25 x 24-28	66	130-142	48	55	5	120	180
10017U025035	25 x 31-35	76	150-158	48	62	5	70	243

PE to PVC Pipe Adaptor

1001Q0

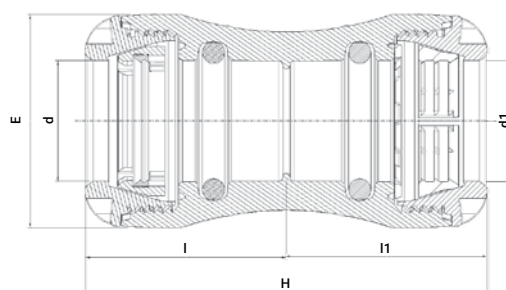

Product Code	Size d x d1*	E	H	I	I1	UB	UC	W
1001Q0025	25 x 25	47	98	48	48	1	200	85
1001Q0032	32 x 32	58	108	53	53	1	150	133
1001Q0040	40 x 40	70	142	70	70	1	100	249
1001Q0050	50 x 50	85	158	78	78	1	55	379
1001Q0063	63 x 63	103	183	90	90	1	30	649

* d1 - PVC connection

Coupling for PVC Pipe

1001QQ

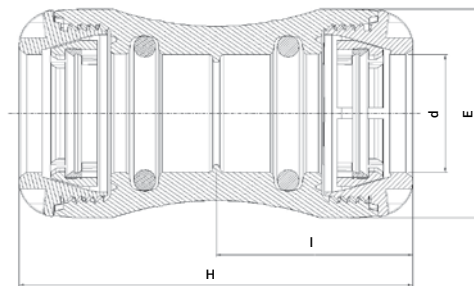

Product Code	Size d	E	H	I	UB	UC	W
1001QQ025	25	47	98	48	1	200	95
1001QQ032	32	58	108	53	1	130	144
1001QQ040	40	70	142	70	1	80	262
1001QQ050	50	85	158	78	1	55	386
1001QQ063	63	103	183	90	1	38	678

Coupler Metric to Imperial (IPS)

1001M6

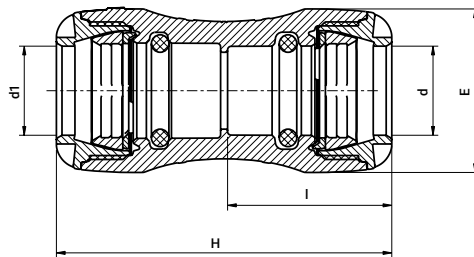

Product Code	Size d x d1	E	H	I	UB	UC	W
1001M6020005	20 x 1/2"	41	92	45	10	400	57
1001M6025005	25 x 1/2"	47	100	48	10	240	76
1001M6025007	25 x 3/4"	47	98	48	10	300	80
1001M6032010	32 x 1"	58	108	53	5	180	130

Male Adaptor with Threaded Brass Offtake

107200

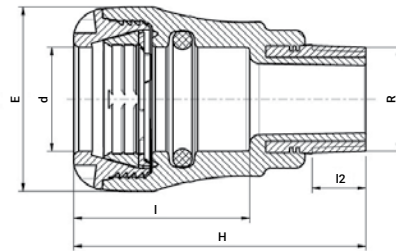

Product Code	Size d x R	E	H	I	I2	UB	UC	W
107200020005	20 x 1/2"	41	76	45	13	1	360	72
107200020007	20 x 3/4"	41	77	45	15	1	320	82
107200025005	25 x 1/2"	47	79	48	13	1	320	82
107200025007	25 x 3/4"	47	80	48	15	1	280	92
107200025010	25 x 1"	47	85	48	17	1	200	126
107200032007	32 x 3/4"	58	88	55	15	1	220	120
107200032010	32 x 1"	58	92	55	17	1	170	153
107200032013	32 x 1 1/4"	58	100	55	19	1	130	200
107200032015	32 x 1 1/2"	58	101	55	19	1	110	239
107200040010	40 x 1"	70	110	73	17	1	130	216
107200040013	40 x 1 1/4"	70	113	73	19	1	110	260
107200040015	40 x 1 1/2"	70	113	73	19	1	100	290
107200050010	50 x 1"	85	127	81	17	1	90	301
107200050013	50 x 1 1/4"	85	127	81	19	1	80	340
107200050015	50 x 1 1/2"	85	120	81	19	1	75	366
107200050020	50 x 2"	85	127	81	23	1	60	449
107200063015	63 x 1 1/2"	103	132	92	19	1	50	500
107200063020	63 x 2"	103	139	92	23	1	50	580

Male Adaptor with Threaded Brass "G" Offtake

1072G0

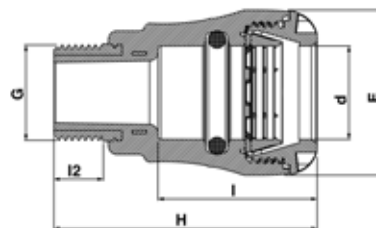

Product Code	Size d x G	H	E	I	I2	UB	UC	W
1072G0020005	20 x 1/2"	76	41	45	13			
1072G0020007	20 x 3/4"	77	41	45	15			
1072G0025005	25 x 1/2"	79	47	48	13			
1072G0025007	25 x 3/4"	80	47	48	15		260	
1072G0025010	25 x 1"	85	47	48	17		200	
1072G0032010	32 x 1"	92	58	55	17		150	
1072G0032013	32 x 1 1/4"	100	58	55	19			
1072G0040013	40 x 1 1/4"	110	70	73	19			
1072G0040015	40 x 1 1/2"	113	70	73	19			
1072G0050015	50 x 1 1/2"	120	85	81	19			
1072G0050020	50 x 2"	127	85	81	23			
1072G0063020	63 x 2"	132	103	92	23			

Female Adaptor with Threaded Brass Offtake

107300

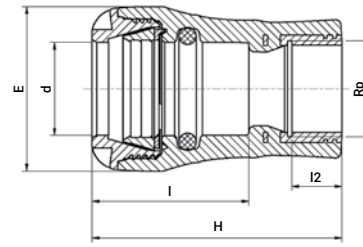

Product Code	Size d x Rp	E	H	I	I2	UB	UC	W
107300020005	20 x 1/2"	41	73	45	15	1	320	80
107300020007	20 x 3/4"	41	80	45	16	1	250	100
107300025005	25 x 1/2"	47	76	48	15	1	280	91
107300025007	25 x 3/4"	47	78	48	16	1	250	100
107300025010	25 x 1"	47	89	48	19	1	180	136
107300032007	32 x 3/4"	58	86	56	16	1	180	132
107300032010	32 x 1"	58	88	56	19	1	160	156
107300032013	32 x 1 1/4"	58	98	56	21	1	120	214
107300040007	40 x 3/4"	70	109	73	16	1	130	196
107300040010	40 x 1"	70	106	73	19	1	130	226
107300040013	40 x 1 1/4"	70	109	73	21	1	110	273
107300040015	40 x 1 1/2"	70	113	73	21	1	100	299
107300050010	50 x 1"	85	113	81	19	1	80	313
107300050013	50 x 1 1/4"	85	124	81	21	1	80	350
107300050015	50 x 1 1/2"	85	118	81	21	1	80	367
107300050020	50 x 2"	85	127	81	26	1	60	457
107300063015	63 x 1 1/2"	103	128	92	21	1	50	515
107300063020	63 x 2"	103	133	92	26	1	45	586

Female Adaptor with Threaded G Brass Offtake

1073G0

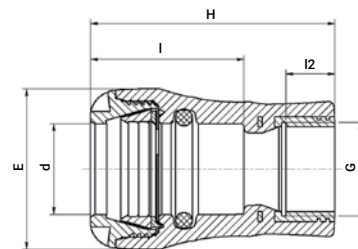

Product Code	Size d x G	H	E	I	I2	UB	UC	W
1073G0020007	20 x 3/4"	80	41	55	12	1	250	100
1073G0025007	25 x 3/4"	78	47	48	12	1	250	100
1073G0025010	25 x 1"	89	47	48	14	1	180	140
1073G0032007	32 x 3/4"	86	58	56	12	1	180	140
1073G0032010	32 x 1"	88	58	56	14	1	160	160
1073G0032013	32 x 1 1/4"	99	58	69	19	1	100	240
1073G0040013	40 x 1 1/4"	109	70	73	19	1	90	260
1073G0040015	40 x 1 1/2"	109	70	81	19	1	-	-
1073G0050015	50 x 1 1/2"	118	85	68	19	1	-	-
1073G0050020	50 x 2"	127	85	88	23	1	-	-
1073G0063020	63 x 2"	133	103	92	23	1	-	-

Female Brass Free Nut Transition

1073F0

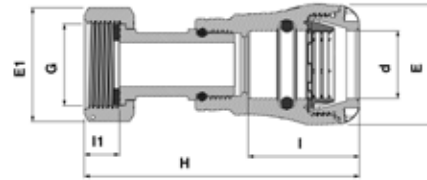

Product Code	Size d x G	H	E	E1	I	I1	UB	UC	W
1073F0020007	20 x 3/4"	109	41	32	45	15			
1073F0025007	25 x 3/4"	113	47	32	48	15			
1073F0025010	25 x 1"	116	47	40	48	17			
1073F0032010	32 x 1"	121	58	40	54	17			
1073F0032013	32 x 1 1/4"	133	58	49	70	17			
1073F0040013	40 x 1 1/4"	151	64	49	70	17			
1073F0040015	40 x 1 1/2"	156	64	54	70	19			
1073F0050015	50 x 1 1/2"	165	85	54	78	19			
1073F0050020	50 x 2"	176	85	68	78	21			
1073F0063020	63 x 2"	191	103	68	90	21			

90° Tee

100400

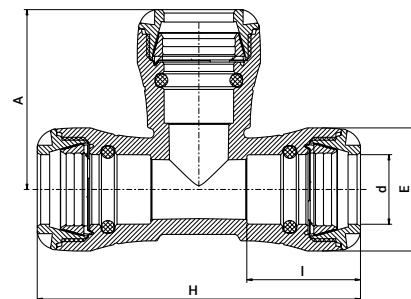

Product Code	Size d	E	H	I	A	UB	UC	W
100400020	20	41	123	45	71	1	180	103
100400025	25	47	134	48	78	1	130	137
100400032	32	58	152	54	84	1	80	221
100400040	40	70	192	70	108	1	45	429
100400050	50	85	214	78	124	1	30	667
100400063	63	103	262	90	147	1	14	1157

90° Reducing Tee

103400

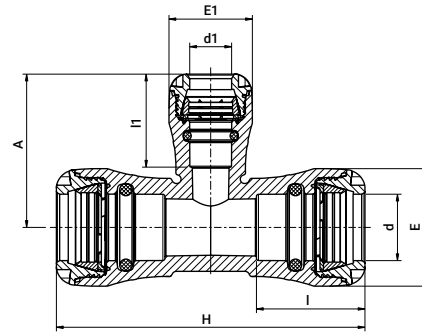

Product Code	Size d x d1 x d	E	H	I	I1	A	E1	UB	UC	W
103400025020	25 x 20 x 25	47	134	48	46	73	41	1	150	127
103400032020	32 x 20 x 32	58	152	54	46	75	41	1	100	185
103400032025	32 x 25 x 32	58	152	54	49	81	47	1	100	195
103400040025	40 x 25 x 40	70	192	70	49	86	47	1	55	325
103400040032	40 x 32 x 40	70	192	70	54	93	58	1	55	358
103400050025	50 x 25 x 50	85	214	78	49	90	47	1	35	500
103400050032	50 x 32 x 50	85	214	78	54	98	58	1	35	530
103400063025	63 x 25 x 63	103	262	90	49	96	47	1	24	848
103400063032	63 x 32 x 63	103	262	90	54	100	58	1	20	871

90° Tee with Threaded Female Offtake

101400

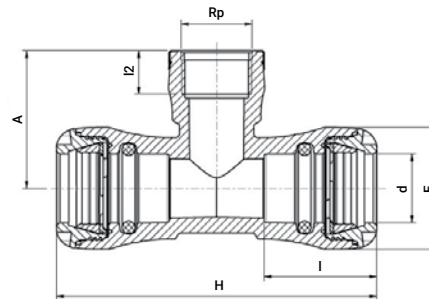

Product Code	Size d x Rp x d	E	H	I	I2	A	UB	UC	W
101400020005	20 x 1/2" x 20	41	123	45	17	43	1	250	84
101400020007	20 x 3/4" x 20	41	123	45	18	46	1	220	88
101400020010	20 x 1" x 20	41	123	45	21	52	1	220	99
101400025005	25 x 1/2" x 25	47	134	48	17	46	1	180	105
101400025007	25 x 3/4" x 25	47	134	48	18	46	1	180	107
101400025010	25 x 1" x 25	47	134	48	21	54	1	180	114
101400032007	32 x 3/4" x 32	58	152	54	18	52	1	100	172
101400032010	32 x 1" x 32	58	152	54	21	55	1	100	183
101400032013	32 x 1 1/4" x 32	58	152	54	24	63	1	80	215
101400040010	40 x 1" x 40	70	192	70	21	65	1	65	304
101400040013	40 x 1 1/4" x 40	70	192	70	24	73	1	45	333

90° Elbow

100500

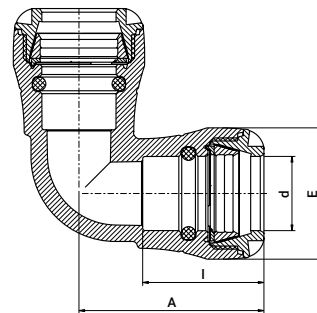

Product Code	Size d	E	I	A	UB	UC	W
100500020	20	41	45	67	1	250	75
100500025	25	47	48	73	1	200	96
100500032	32	58	54	81	1	130	157
100500040	40	70	70	106	1	65	291
100500050	50	85	78	119	1	40	462
100500063	63	103	90	141	1	25	799

45° Elbow

100600

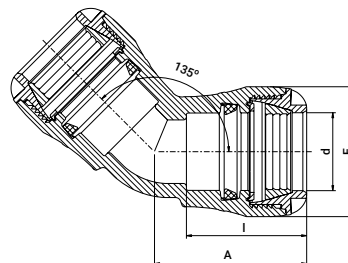

Product Code	Size d	E	I	A	UB	UC	W
100600032	32	58	54	67	1	150	142
100600040	40	70	71	88	1	80	263
100600050	50	85	79	100	1	40	428
100600063	63	103	90	118	1	25	719

Wall Plate Elbow

107500

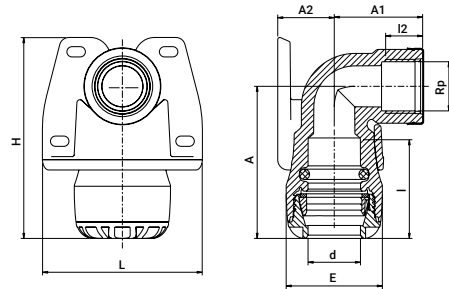

Product Code	Size d x Rp	E	H	I	I2	A	A1	A2	L	UB	UC	W
107500020005	20 x 1/2"	41	95	45	17	67	39	28	73	1	200	92
107500020007	20 x 3/4"	41	95	45	18	67	43	28	73	1	200	96
107500025005	25 x 1/2"	47	98	48	17	74	40	28	78	1	180	110
107500025007	25 x 3/4"	47	98	48	18	74	43	28	78	1	180	116

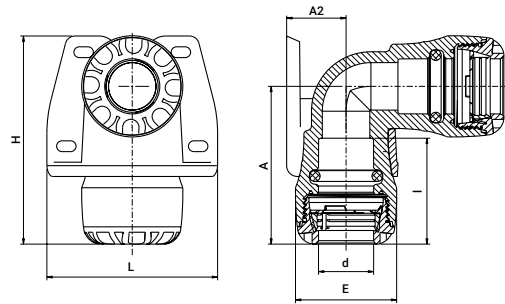

Product Code	Size d x d	E	H	I	A	A2	L	UB	UC	W
107500025	25 x 25	47	98	48	74	28	78	5	125	138

90° Reducing Elbow

105100

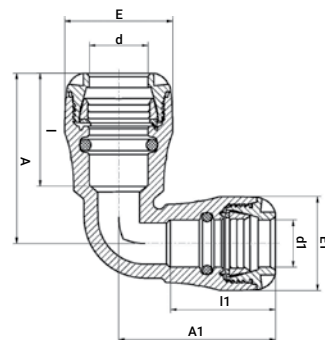

Product Code	Size d x d1	E	I	I1	A	A1	E1	UB	UC	W
105100025020	25 x 20	47	48	46	74	68	41	1	200	90

90° Elbow Metric to Imperial (IPS)

1005M6

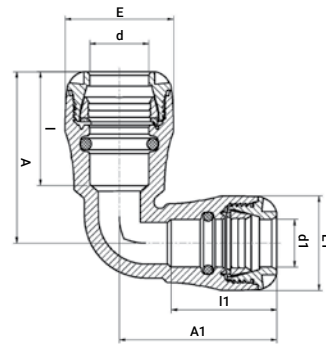

Product Code	Size d x d1	E	I	I1	A	A1	E1	UB	UC	W
1005M6025005	25 x 1/2"	47	48	46	74	68	41	10	180	89
1005M6025007	25 x 3/4"	47	48	48	73	73	47	10	160	101

90° Elbow with Threaded Male Offtake

108500

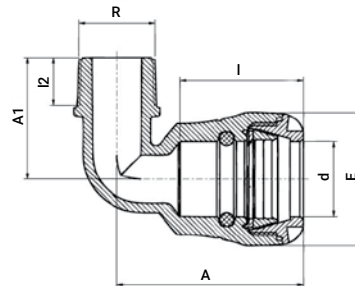

Product Code	Size d x R	E	I	I2	A	A1	UB	UC	W
108500020005	20 x 1/2"	41	45	16	66	41	1	380	47
108500020007	20 x 3/4"	41	45	17	66	42	1	380	52
108500025005	25 x 1/2"	47	48	16	74	44	1	350	57
108500025007	25 x 3/4"	47	48	17	74	45	1	300	64
108500025010	25 x 1"	47	48	19	74	47	1	280	65
108500032007	32 x 3/4"	58	53	17	81	51	1	220	90
108500032010	32 x 1"	58	53	19	81	53	1	220	92
108500032013	32 x 1 1/4"	58	53	21	81	54	1	180	114
108500032015	32 x 1 1/2"	58	53	22	81	62	1	180	130
108500032020	32 x 2"	58	53	25	89	66	1	130	147
108500040010	40 x 1"	70	71	19	107	57	1	110	173
108500040013	40 x 1 1/4"	70	71	21	107	58	1	100	189
108500040015	40 x 1 1/2"	70	71	21	107	60	1	100	194
108500050013	50 x 1 1/4"	85	79	22	122	68	1	65	277
108500050015	50 x 1 1/2"	85	79	21	122	68	1	65	290
108500063013	60 x 1 1/4"	103	90	22	143	76	1	40	447
108500063015	63 x 1 1/2"	103	90	21	143	78	1	40	458
108500063020	63 x 2"	103	90	25	143	81	1	40	492

45° Elbow with Threaded Male Offtake

104500

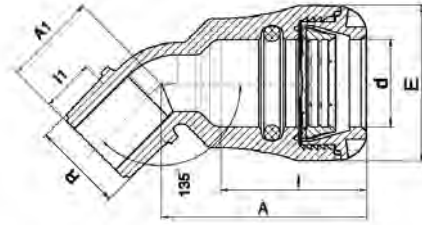

Product Code	Size d x R	E	I	I1	A	A1	UB	UC	W
104500032010	32 x 1"	58	54	19	76	35	1	220	89
104500040013	40 x 1 1/4"	70	70	21	96	40	1	120	163

90° Elbow with Threaded Female Offtake

101500

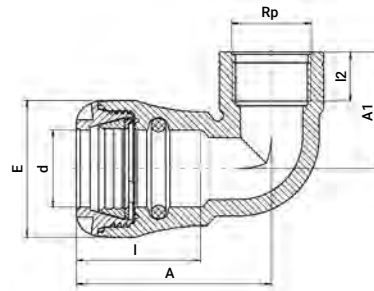

Product Code	Size d x Rp	E	I	I2	A	A1	UB	UC	W
101500020005	20 x 1/2"	41	45	17	67	39	1	300	51
101500020007	20 x 3/4"	41	45	18	67	43	1	300	55
101500020010	20 x 1"	41	45	21	67	49	1	300	64
101500025005	25 x 1/2"	47	48	17	74	40	1	280	63
101500025007	25 x 3/4"	47	48	18	74	43	1	250	70
101500025010	25 x 1"	47	48	21	74	50	1	220	82
101500032007	32 x 3/4"	58	54	18	83	45	1	220	95
101500032010	32 x 1"	58	54	21	83	49	1	200	111
101500032013	32 x 1 1/4"	58	54	24	83	60	1	150	145
101500040010	40 x 1"	70	72	21	107	51	1	110	179
101500040013	40 x 1 1/4"	70	72	24	107	61	1	100	226
101500040015	40 x 1 1/2"	70	72	24	107	65	1	90	244
101500050015	50 x 1 1/2"	85	79	24	119	63	1	60	330
101500050020	50 x 2"	85	79	29	119	75	1	55	349
101500063020	63 x 2"	103	79	29	141	70	1	35	534

90° Elbow with Threaded Brass Male Offtake

107700

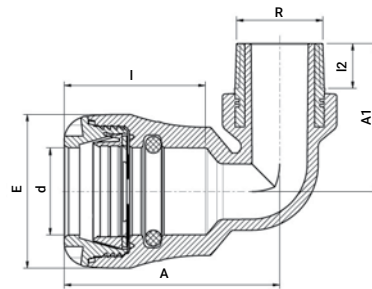

Product Code	Size d x R	E	I	I2	A	A1	UB	UC	W
107700032007	32 x 3/4"	58	53	15	81	80	1	110	239
107700032010	32 x 1"	58	53	17	81	83	1	150	172
107700032013	32 x 1 1/4"	58	53	19	81	83	1	90	285
107700032015	32 x 1 1/2"	58	53	19	81	83	1	85	305
107700040010	40 x 1"	70	59	17	104	71	1	90	239
107700040013	40 x 1 1/4"	70	59	19	104	71	1	90	295
107700040015	40 x 1 1/2"	70	59	19	104	71	1	85	341
107700050010	50 x 1"	85	79	19	116	62	1	70	337
107700050013	50 x 1 1/4"	85	79	21	116	68	1	70	384
107700050015	50 x 1 1/2"	85	79	21	116	73	1	50	431
107700050020	50 x 2"	85	79	23	116	85	1	50	538
107700063013	63 x 1 1/4"	103	90	21	143	74	1	40	559
107700063015	63 x 1 1/2"	103	90	21	143	74	1	40	592
107700063020	63 x 2"	103	90	26	143	85	1	40	726

90° Elbow with Threaded Brass Female Offtake

107600

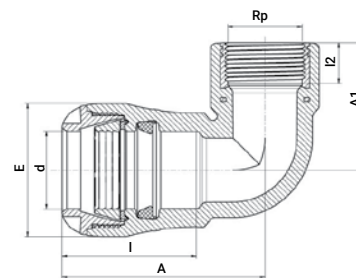

Product Code	Size d x Rp	E	I	I2	A	A1	UB	UC	W
107600032010	32 x 1"	58	53	19	73	60	1	140	187
107600040007	40 x 3/4"	70	72	16	107	51	1	120	219
107600040010	40 x 1"	70	72	19	107	60	1	90	266
107600040013	40 x 1 1/4"	70	72	21	107	67	1	90	313
107600040015	40 x 1 1/2"	70	72	21	107	70	1	85	355
107600050010	50 x 1"	85	79	19	122	60	1	70	349
107600050013	50 x 1 1/4"	85	79	21	122	67	1	60	403
107600050015	50 x 1 1/2"	85	79	21	122	73	1	60	455
107600050020	50 x 2"	85	79	26	122	84	1	50	558
107600063013	63 x 1 1/4"	103	90	21	143	68	1	40	575
107600063015	63 x 1 1/2"	103	90	21	143	72	1	40	625
107600063020	63 x 2"	103	90	26	143	82	1	35	747

90° Elbow Female Brass Free Nut Transition

1076F0

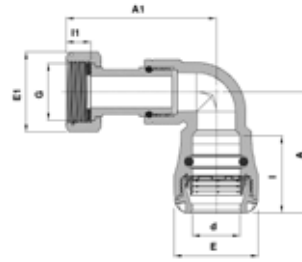

Product Code	Size d x G	E	E1	I	I1	A	A1	UB	UC	W
1076F0032010	32x1"	58	40	54	17	83	90			
1076F0032013	32x1¼"	58	49	54	17	83	103			
1076F0040013	40x1¼"	70	49	72	17	107	105			
1076F0040015	40x1½"	70	54	72	19	107	116			
1076F0050015	50x1½"	85	54	79	19	119	116			
1076F0050020	50X2"	85	68	79	21	119	130			
1076F0063020	63x2"	103	68	79	21	141	130			



PA Ball Valve

Full Bore Ball Valve With A Drain Port Option!



Features and benefits

- Full bore design minimizing pressure loss
- Two drain ports
- Rated PN16
- Glass Reinforced Polyamide body



PLASSON'S Ball Valve is produced entirely of plastic, eliminating the risk of corrosive damage to the system.

PLASSON'S Ball Valve features an option for two ISO 7-2 Rp drain ports or no drain ports. Ideally suited for draining or sampling of potable water systems and monitoring system pressure.



Removable Tamper Resistant Handle

Easily identifiable drain port option:

- Blue dot - no drain port
- Black plug- optional drain port



Two Drain Port Option

PA Ball Valve Series 1 x Series 1

NEW!

037100

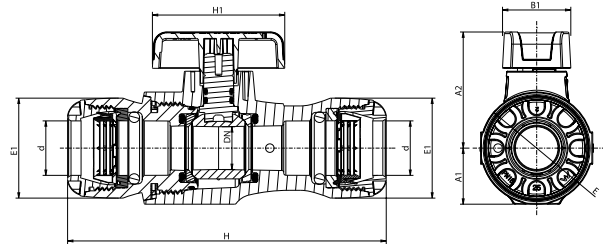

Product Code	Size d	Rp	DN	A1	A2	H	E	E1	UB	UC	W
03710S00025	25	1/8"	20	27	54	150	53	47	—		
03710S00032	32	1/8"	25	33	64	170	64	58	—		

* 03710SF - with drain port | * 03710SF – con sistema de purga

PA Ball Valve Series 1 x Male

NEW!

0371002

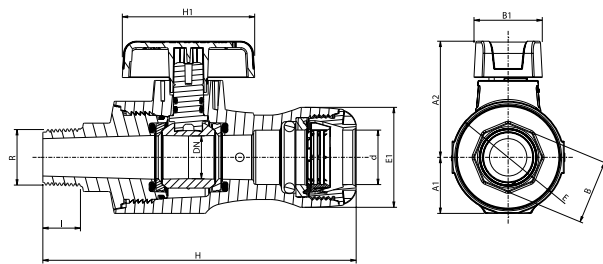

Product Code	Size dxR	Rp	DN	A1	A2	H	I2	B	E	E1	UC	W
03710020S00025007	25 x 3/4"	1/8"	20	27	54	148	18	30	53	47		
03710020S00032010	32 x 1"	1/8"	25	33	64	165	21	41	64	58		

* 03710020SF - with drain port | * 03710020SF – con sistema de purga

PA Ball Valve Series 1 x Female

NEW!

0371003

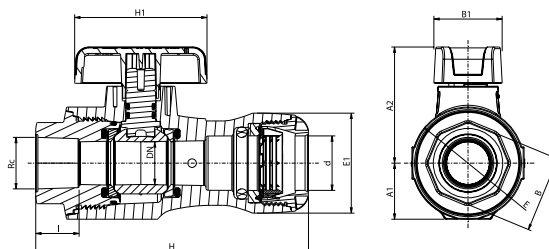

Product Code	Size dxRc	Rp	DN	A1	A2	H	I2	B	E	E1	UC	W
03710030S00025007	25 x 3/4"	1/8"	20	27	54	129	19	36	53	47		
03710030S00032010	32 x 1"	1/8"	25	33	64	148	22	46	64	58		

* 03710030SF - with drain port | * 03710030SF – con sistema de purga

PA Ball Valve Series 1 x Free Nut

NEW!

0371016

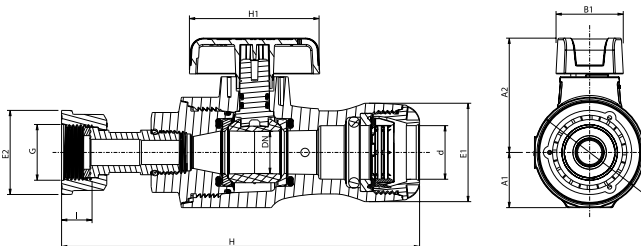

Product Code	Size dxG	Rp	DN	A1	A2	H	E	E1	E1	UC	W
0371016S00025007	25 x 3/4"	1/8"	20	27	54	171	53	47	40		
0371016S00025010	25 x 1"	1/8"	25	27	54	179	53	47	48		
0371016S00032010	32 x 1"	1/8"	32	33	64	192	64	57	48		

* 0371016SF - with drain port | * 0371016SF – con sistema de purga

Compression Stoptap

034100

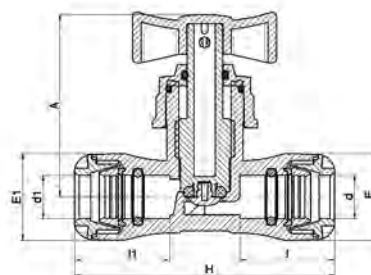

Product Code	Size d x d1	E	H	I	I1	A	E1	UB	UC	W
034100020	20 x 20	41	123	45	—	89	—	1	130	145
034100025	25 x 25	47	134	48	—	89	—	1	130	167
034100025020	25 x 20	47	129	48	45	89	42	1	130	161
034100032	32 x 32	58	152	54	—	89	—	1	80	225

Stoptap - Copper Pipe Adaptor

0341C0

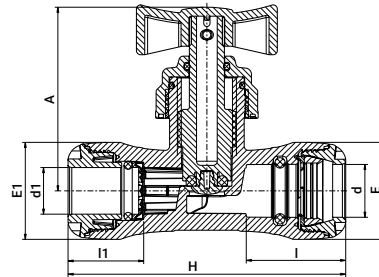

Product Code	Size d x d1	E	H	I	I1	A	E1	UB	UC	W
0341C0020015	20 x 15	41	123	45	45	89	41	1	130	149
0341C0025015	25 x 15	47	129	48	46	89	42	1	130	165
0341C0025022	25 x 22	47	134	48	48	89	47	1	130	171
0341C0032028	32 x 28	58	159	54	54	89	58	1	80	223

Free Nut Union for Water Meter

0358916

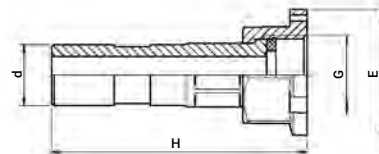

Product Code	Size d x G	E	H	UB	UC	W
0358916020	20 x 3/4"	42	86	1	150	75
0358916025	25 x 1"	50	90	1	150	111

Free Nut Adaptor with Check Valve

0358917

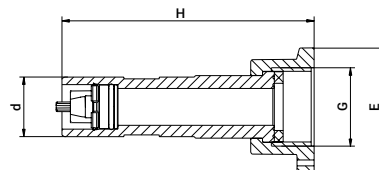

Product Code	Size d x G	E	H	UB	UC	W
0358917020	20 x 3/4"	44	86	10	300	40
0358917025	25 x 1"	50	90	10	300	58

PLASSON Series 1 Wrench

109900



Product Code	Size	UB	UC	W
10990004P	20 - 32	—	300	72
10990002P	40 - 63	—	100	285

Chamfer Tool for PE Pipes

189600



Product Code	Size	UB	UC	W
189600063020P	20 - 63	1	180	86

Nut

100040

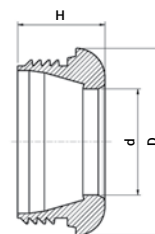

Product Code	Size d	D	H	UB	UC	W
100040020P	20	40	22	50	1400	7
100040025P	25	45	22	50	1200	8
100040032P	32	57	24	50	900	15
100040040P	40	68	33	50	500	29
100040050P	50	83	37	—	300	44
100040063P	63	100	43	—	200	60

NBR O-Ring

100020



Product Code	Pipe Size	E	e	UB	UC	W
100020020P	20	19	4	50	32000	1
100020025P	25	24	5	50	16000	2
100020032P	32	31	6	50	10000	4

EPDM O-Ring

10002D



Product Code	Pipe Size	E	e	UB	UC	W
10002D020	20	19	14	50	32000	1
10002D025	25	24	5	50	16000	2
10002D032	32	31	6	50	8000	4

NBR Shaped Seal

100029



Product Code	Pipe Size	E	e	UB	UC	W
100029040P	40	38	10	50	4000	8
100029050P	50	49	10	50	2500	11
100029063P	63	61	11	50	2000	15

EPDM Shaped Seal

10002D9



Product Code	Pipe Size	E	e	UB	UC	W
10002D940	40	38	10	50	4000	7
10002D950	50	48.6	10	50	2500	9
10002D963	63	60.6	11	50	2000	13

Split Ring

100030

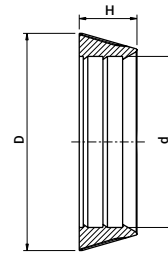

Product Code	Size d	D	H	UB	UC	W
100030020P	20	27	9	50	6000	2
100030025P	25	33	9	50	4500	3
100030032P	32	42	11	50	2000	4
100030040P	40	52	14	50	1600	14
100030050P	50	64	17	50	500	14
100030063P	63	81	21	50	500	27

Grip Ring

100080

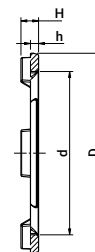

Product Code	Size d	D	H	h	UB	UC	W
100080020P	20	27	4	2	50	7000	1
100080025P	25	33	4	2	50	5500	1
100080032P	32	42	4	2	50	3000	1
100080040P	40	52	4	2	50	2500	2
100080050P	50	64	4	3	50	1000	3
100080063P	63	80	5	3	50	1000	6

PVC Pipe Adaptor Kit

1091Q0

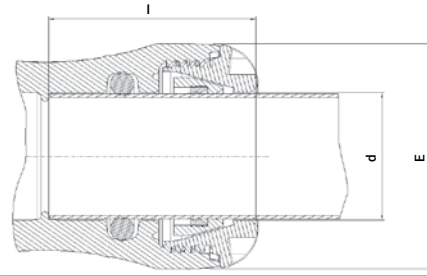

Product Code	Size d	E	I	UB	UC	W
1091Q0025	25	47	48	1	500	26
1091Q0032	32	58	53	1	400	31
1091Q0040	40	70	70	1	300	56
1091Q0050	50	85	78	1	200	72
1091Q0063	63	103	90	1	130	134

MECHANICAL FITTINGS

ELECTROFUSION FITTINGS

TOOLING

SERIES 1

SILVER LINE

Installation Instructions

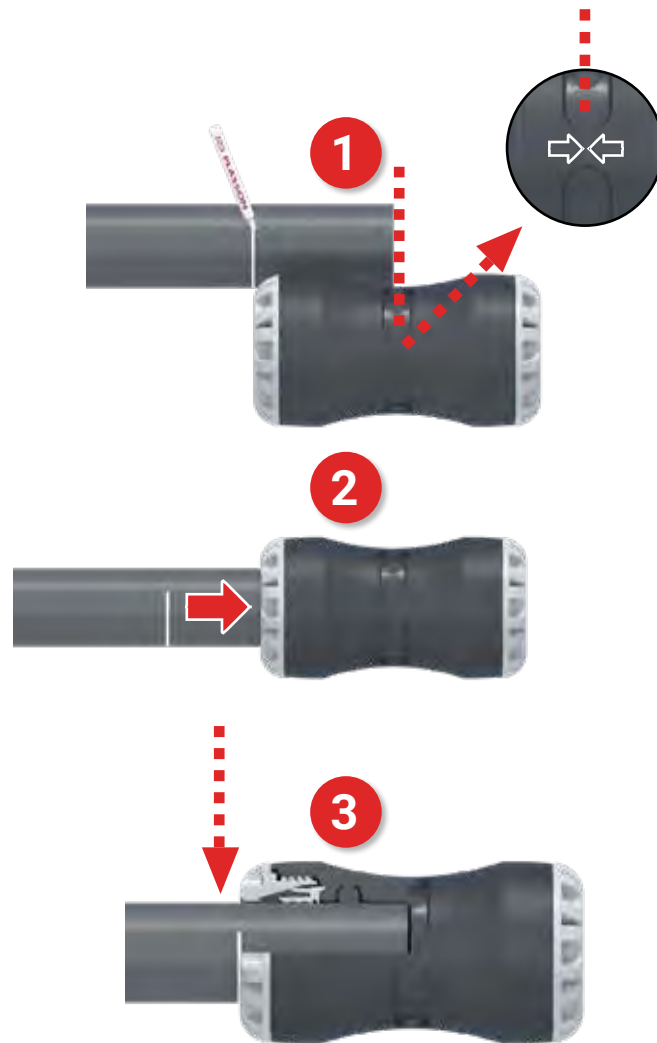

Disassembly

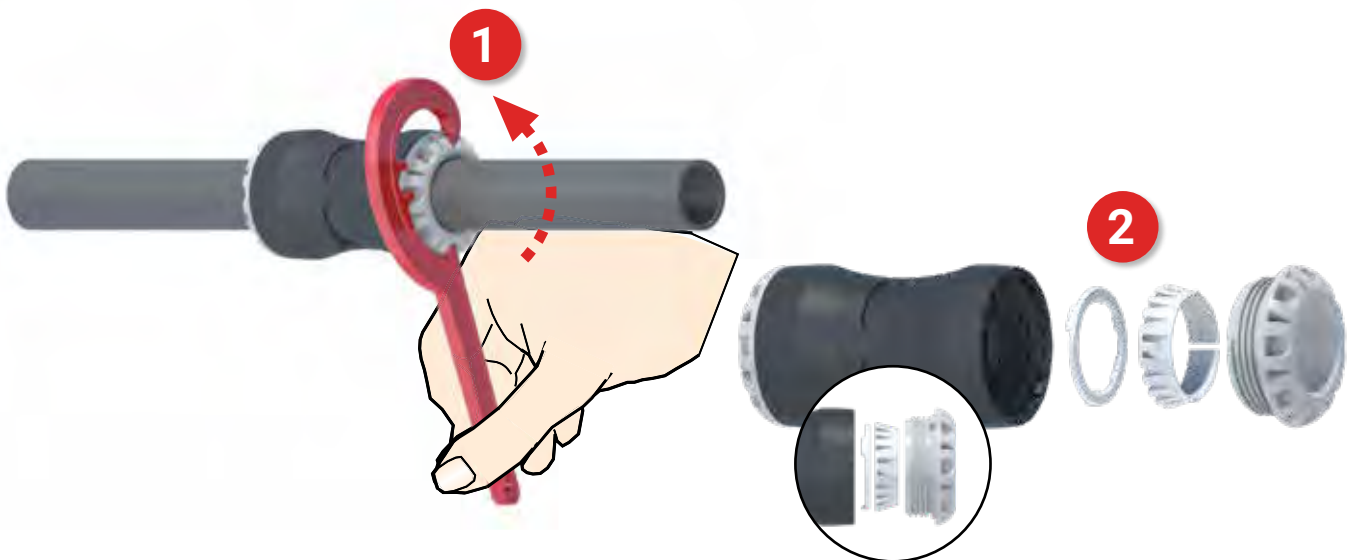

Assembly Instructions PVC Pipe Kit

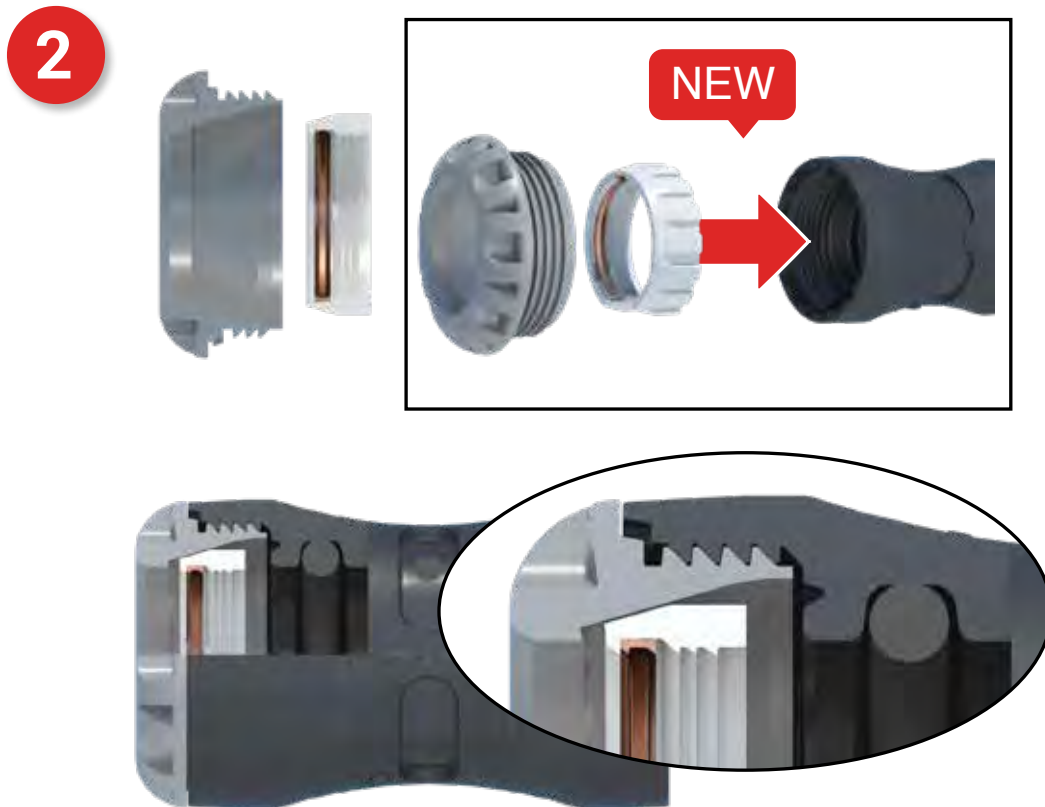
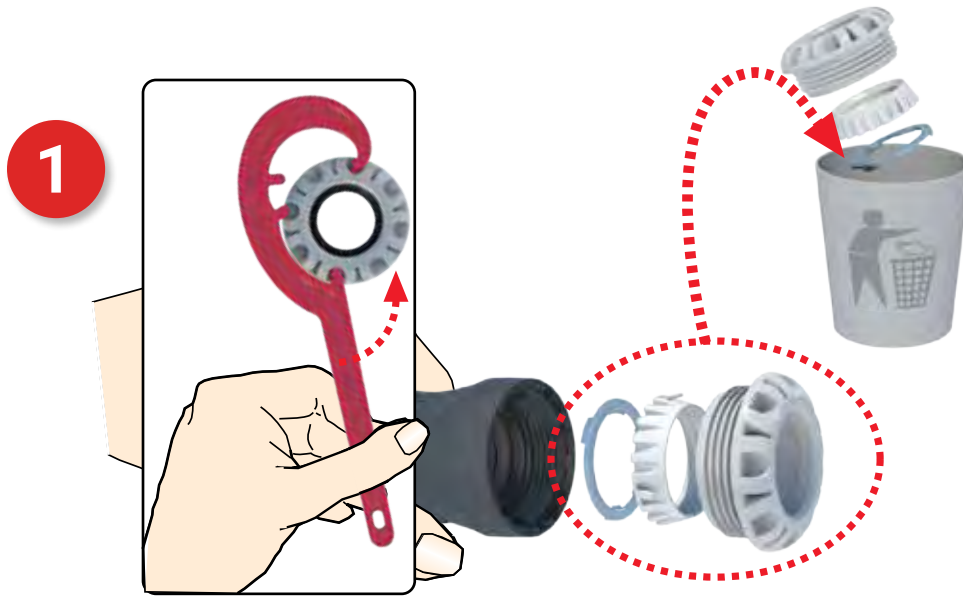

Plasson Universal Slip Repair Coupler Assembly Instructions

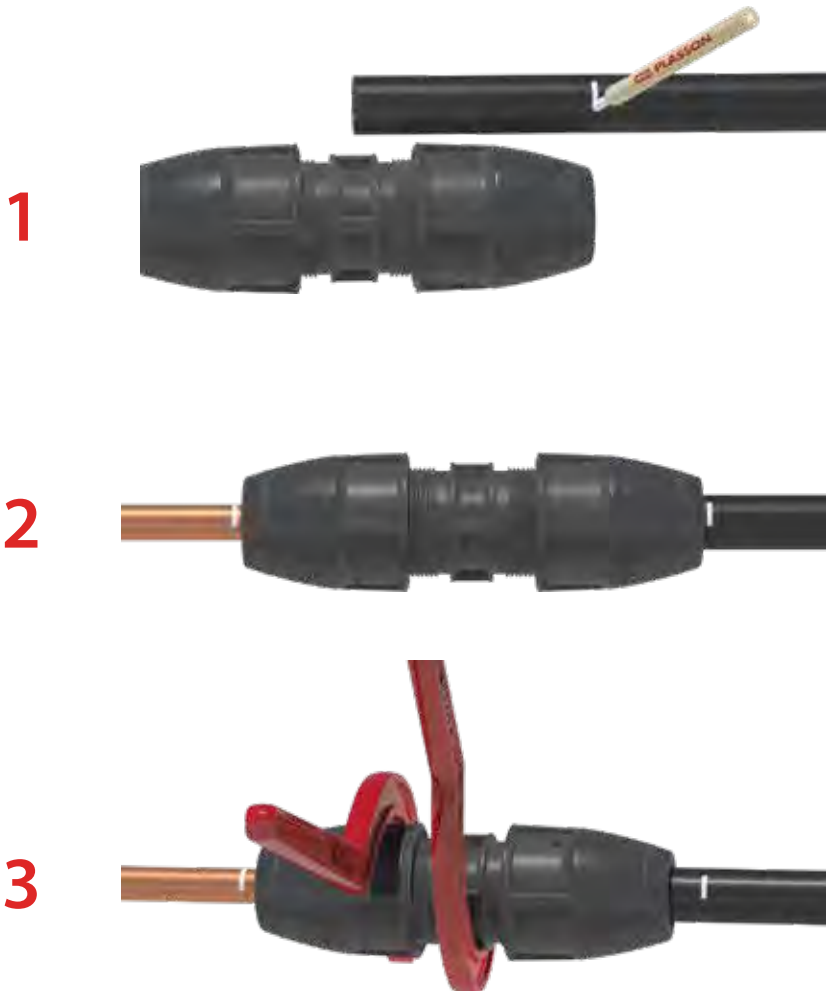

1. Mark pipe insertion depth on the pipe (approximately half the fitting length). Undo nuts 1 to 2 turns while ensuring they remain on the fitting.
2. Insert the pipe until the mark reaches the end of the nut.
3. While holding the fitting body with a Plasson wrench (or a similar tool) tighten the nut firmly with a second wrench.

Note: If the fitting is reused, make sure metal teeth are present in the split ring.



PLASSON G-PLASS - Features and Benefits:

- Designed, tested, and approved for use in gas systems in accordance with ISO 17885 standard.
- Diameters 32-63 mm in various geometries: couplers, elbows, tees and threaded male transitions.
- Fast and simple assembly, ideal for house connections.
- Compact size - enables assembly in confined spaces.
- Designed to accommodate PLASSON EFV (Excess Flow Valve).
- Multiple sealing elements ensuring leak-tight assembly.
- Full end load performance.
- Approvals:
 - ISO 17885 for Gas
 - DVGW G 5600-2

Coupler

150100

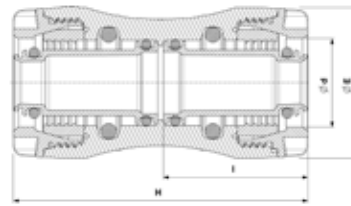

Product Code	Size d	E	H	I	UB	W
150100032	32	58	112	55		
150100040	40	70	148	73		
150100050	50	85	167	82		
150100063	63	103	192	95		

Reducing Coupler

151100

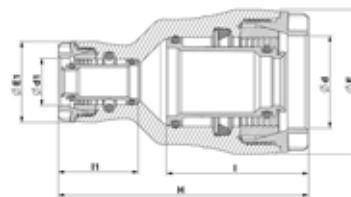

Product Code	Size d	E	E1	H	I	L1	UB	W
151100040032	40 x 32	70	58	144	74	57		
151100050032	50 x 32	85	58	158	83	57		
151100050040	50 x 40	85	70	172	83	57		
151100063032	63 x 32	103	58	177	96	57		
151100063040	63 x 40	103	70	192	96	75		
151100063050	63 x 50	103	85	196	96	85		

45° Elbow

150600

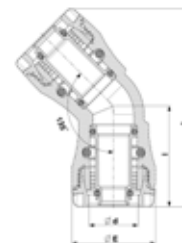

Product Code	Size d	E	A	I	UB	W
150600032	32	58	69	56		
150600040	40	70	91	74		
150600050	50	85	104	83		
150600063	63	103	123	95		

90° Elbow

150500

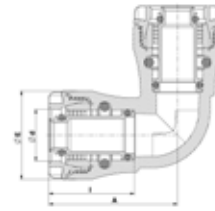

Product Code	Size d	E	A	I	UB	W
150500032	32	58	83	56		
150500040	40	70	109	73		
150500050	50	85	123	82		
150500063	63	103	146	95		

90° Tee

150400

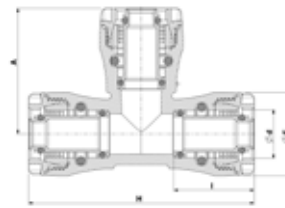

Product Code	Size d	E	A	H	I	UB	W
150400032	32	58	86	156	56		
150400040	40	70	111	198	73		
150400050	50	85	128	223	82		
150400063	63	103	152	271	95		

90° Reducing Tee

153400

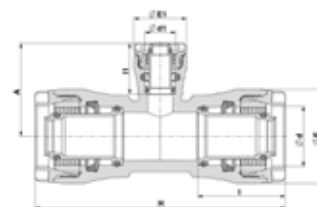

Product Code	Size d	A	E	E1	H	I	L1	UB	W
153400040032	40 x 32 x 40	95	70	58	198	73	56		
153400050032	50 x 32 x 50	100	85	58	223	82	56		
153400063032	63 x 32 x 63	102	103	58	271	95	56		

Male Adaptor

150200

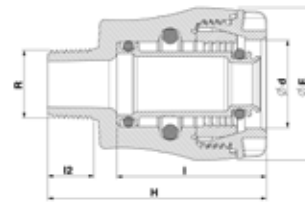

Product Code	Size dxR	E	H	I	L2	UB	W
150200032010	32 x 1"	58	87	57	19		
150200040013	40 x 1 1/4"	70	109	76	21		
150200050015	50 x 1 1/2"	85	118	85	21		
150200063020	63 x 2"	103	133	97	25		

Male Adaptor with Threaded Brass Offtake

157200

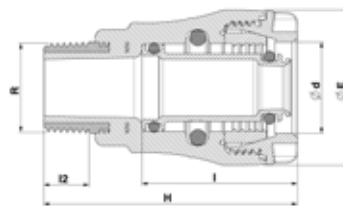

Product Code	Size dxR	E	H	I	L2	UB	W
157200032010	32 x 1"	58	95	57	17		
157200040013	40 x 1 1/4"	70	117	76	19		
157200050015	50 x 1 1/2"	85	126	85	19		
157200063020	63 x 2"	103	144	97	23		

End Cap Body for Gas

151200

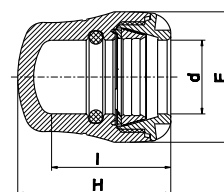

Product Code	Size d	E	H	I	UB	W
151200032	32	58	70	55		
151200040	40	70	93	74		
151200050	50	85	106	84		
151200063	63	103	122	95		

G-PLASS Liner

159511

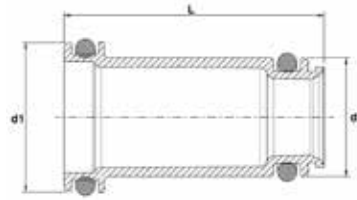

Product Code	Size d	L	d1	d2	UB	W
159511032P	32	55	31.7	25.0		
159511040P	40	68	38.7	31.2		
159511050P	50	76	48.9	39.3		
159511063P	63	85	62.8	50.0		

G-PLASS Nut

150040

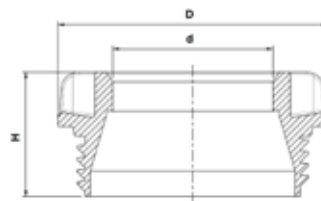

Product Code	Size d	D	H	UB	W
150040032P	32	56,4	26,2		
150040040P	40	68,0	35,6		
150040050P	50	82,5	41,4		
150040063P	63	99,3	47,7		

G-PLASS Split Ring

150030

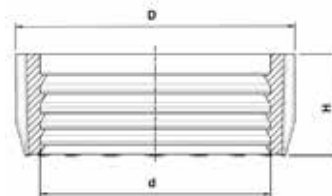

Product Code	Size d	D	H	UB	W
150030032P	32	44,1	15,8		
150030040P	40	53,1	21,5		
150030050P	50	66,0	25,5		
150030063P	63	84,5	27,6		

G-PLASS O-Ring/Shaped Seal

150020/100029

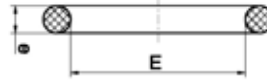

Product Code	Size d	E	e	UB	W
150020032P	32	31	6		
150029040P*	40	38	10		
150029050P*	50	49	10		
150029063P*	63	61	11		

* Shaped Seal

G-PLASS Wrench

159900



Product Code	Size	UB	W
15990002P	32-63	1	150

G-PLASS Integral Chamfer Tool



Product Code	Size	UB	W
159600063020	20-63	1	230

08019232

GPLASS

Trusted Gas Fitting



Instruction For Use



08019232

GPLASS

Trusted Gas Fitting

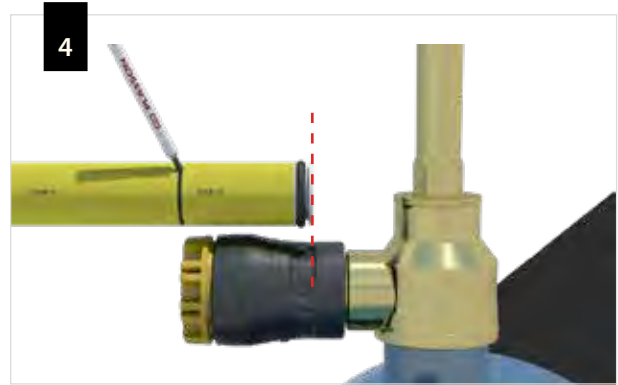

Instruction For Use





The logo consists of a red square containing a white stylized 'P' symbol, followed by the word 'PLASSON' in white, uppercase, sans-serif font.

PLASSON

SILVER LINE FITTINGS



Silver Line

140100

Page 242 | Coupling
Enlace Recto



141100

Page 243 | Reducing Coupling



140200

Page 243 | Male Adaptor
Enlace Mixto Rosca Macho



140300

Page 244 | Female Adaptor
Enlace Mixto Rosca Hembra



141200

Page 244 | End Plug
Tapón Final



140400

Page 245 | 90° Tee
Te de 90°



141400

Page 245 | 90° Tee with Threaded
Female Offtake
Te de 90° Compresión
Rosca Hembra



148400

Page 246 | 90° Tee with Threaded
Male Offtake
Te de 90° Compresión
Rosca Macho



143400

Page 246 | 90° Reducing Tee With
Irrifit Outlet
Te de 90° Reductor



140500

Page 247 | 90° Elbow
Codo de 90°



141500

Page 247 | 90° Elbow with Threaded
Female Offtake
Codo de 90° Compresión
Rosca Hembra



148500

Page 248 | 90° Elbow with Threaded
Male Offtake
Codo de 90° Compresión
Rosca Macho



146500

Page 248 | Corner Elbow
Codo de Esquina



149300

Page 249 | Reducing Set
Juego Reductor

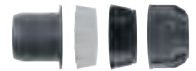

1401M0

Page 249 | Coupler Union Adaptor
Enlace Recto Con Racor



1498M0

Page 250 | Union Adaptor
Adaptador A Rosca Macho



142500

Page 250 | Threaded Adaptor
Adaptador Roscado



078901

Page 251 | Threaded Male Adaptor
Adaptador Compresión
Rosca Macho



148940

Page 251 | Nut Threaded Adaptor
Tuerca para Adaptador de
Compresión



140040

Page 252 | Nut
Racor



140030

Page 252 | Split Ring - Polyacetal
Casquillo de Apriete (acetal)



070020

Page 253 | O-Ring
Junta Tórica/Seiil



140050

Page 253 | Insert
Inserto de PP



Coupling

140100

Enlace Recto

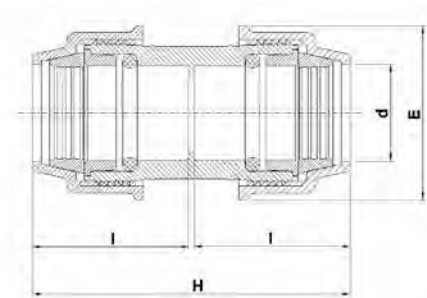

Product Code	Size d x d	E	H	I	UB	UC	W
140100016	16 x 16	39	105	50	10	400	50
140100020	20 x 20	42	90	44	10	500	40
140100025	25 x 25	50	98	48	10	300	60
140100032	32 x 32	61	114	56	10	160	100
140100040	40 x 40	73	127	62	—	100	150
140100050	50 x 50	92	146	71	—	60	250
140100063	63 x 63	106	167	82	—	40	400

Reducing Coupling

141100

Enlace Recto Reductor

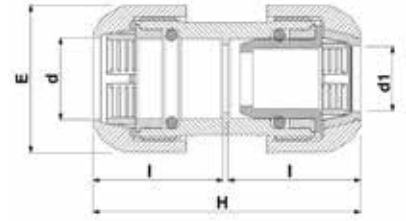

Product Code	Size d x d	E	H	I	UB	UC	W
141100025020	25x20	50	98	48	10	240	70
141100032020	32x20	61	114	56	10	160	120
141100032025	32x25	61	114	56	10	160	120
141100040025	40x25	73	127	62	—	120	200
141100040032	40x32	73	127	62	—	120	180
141100050025	50x25	92	146	71	—	60	340
141100050032	50x32	92	146	71	—	60	340
141100050040	50x40	92	146	71	—	60	330
141100063025	63x25	106	167	82	—	40	520
141100063032	63x32	106	167	82	—	40	510
141100063040	63x40	106	167	82	—	40	510
141100063050	63x50	106	167	82	—	40	420

Male Adaptor

140200

Enlace Mixto Rosca Macho

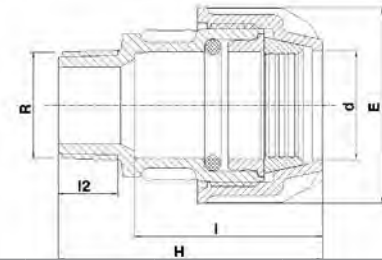

Product Code	Size d x R	E	H	I	I2	UB	UC	W
140200016003	16 x 3/8"	32	73	59	13	10	500	30
140200016005	16 x 1/2"	39	79	59	16	10	500	30
140200016007	16 x 3/4"	39	80	59	17	10	500	30
140200020005	20 x 1/2"	42	71	50	17	10	600	20
140200020007	20 x 3/4"	42	71	50	18	10	600	20
140200020010	20 x 1"	50	77	50	20	10	480	40
140200025005	25 x 1/2"	50	75	54	17	10	480	30
140200025007	25 x 3/4"	50	75	54	17	10	480	40
140200025010	25 x 1"	50	77	50	18	10	480	40
140200032007	32 x 3/4"	61	82	66	20	10	280	60
140200032010	32 x 1"	61	84	60	18	10	280	60
140200032013	32 x 1 1/4"	61	86	58	20	10	280	70
140200032015	32 x 1 1/2"	73	98	73	22	—	150	130
140200040010	40 x 1"	73	97	73	22	—	150	90
140200040013	40 x 1 1/4"	73	99	73	20	—	150	90
140200040015	40 x 1 1/2"	73	98	73	22	—	150	100
140200040020	40 x 2"	92	110	80	26	—	100	220
140200050015	50 x 1 1/2"	92	107	80	22	—	100	150
140200050020	50 x 2"	92	110	90	26	—	100	150
140200063020	63 x 2"	106	120	99	26	—	60	270

Female Adaptor

140300

Enlace Mixto Rosca Hembra

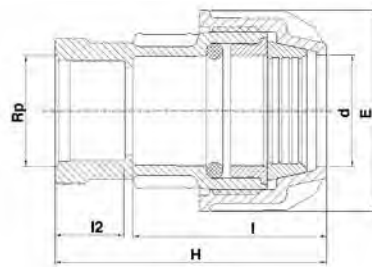

Product Code	Size d x Rp	E	H	I	I2	UB	UC	W
140300016005	16 x 1/2"	39	77	55	19	10	500	40
140300016007	16 x 3/4"	39	79	56	19	10	500	40
140300020005	20 x 1/2"	42	71	51	18	10	600	30
140300020007	20 x 3/4"	42	72	51	19	10	600	30
140300020010	20 x 1"	50	80	54	21	10	300	30
140300025007	25 x 3/4"	50	75	54	19	10	400	40
140300025010	25 x 1"	50	80	54	21	10	400	40
140300032007	32 x 3/4"	61	82	61	19	10	280	60
140300032010	32 x 1"	61	84	61	21	10	230	60
140300032013	32 x 1 1/4"	73	101	73	25	5	150	70
140300032015	32 x 1 1/2"	73	101	73	25	—	150	120
140300040010	40 x 1"	73	97	73	21	—	150	100
140300040013	40 x 1 1/4"	73	101	73	25	—	150	110
140300040015	40 x 1 1/2"	73	101	73	25	—	150	120
140300050015	50 x 1 1/2"	92	107	82	25	—	90	170
140300050020	50 x 2"	92	112	82	30	—	90	190
140300063020	63 x 2"	106	119	86	30	—	60	260

End Plug

141200

Tapón Final

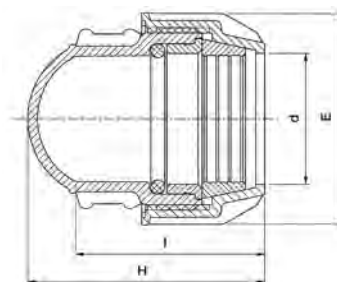

Product Code	Size d	E	H	I	UB	UC	W
141200025	25	50	59	48	10	520	30
141200032	32	61	67	54	10	330	53
141200040	40	73	80	67	—	180	80
141200050	50	92	93	71	—	100	54
141200063	63	105	112	80	—	60	86

90° Tee

140400

Te de 90°

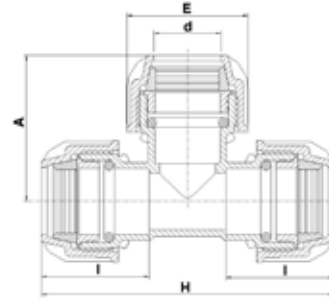

Product Code	Size d x d x d	E	H	I	A	UB	UC	W
140400016	16 x 16 x 16	39	126	50	63	10	200	79
140400020	20 x 20 x 20	42	113	43	57	10	250	77
140400025	25 x 25 x 25	50	124	47	60	10	170	85
140400032	32 x 32 x 32	61	150	56	75	5	100	148
140400040	40 x 40 x 40	73	173	62	86	—	60	244
140400050	50 x 50 x 50	92	207	74	104	—	32	394
140400063	63 x 63 x 63	106	239	82	119	—	20	643

90° Tee with Threaded Female Offtake

141400

Te de 90° Compresión Rosca Hembra

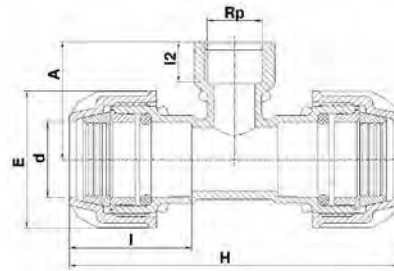

Product Code	Size d x Rp x d	E	H	I	I2	A	UB	UC	W
141400016005	16 x 1/2" x 16	39	124	51	19	30	10	240	66
141400016007	16 x 3/4" x 16	39	122	50	19	30	10	240	59
141400020005	20 x 1/2" x 20	42	113	44	18	43	10	320	48
141400020007	20 x 3/4" x 20	42	113	44	19	45	10	320	50
141400025005	25 x 1/2" x 25	50	123	48	18	45	10	200	71
141400025007	25 x 3/4" x 25	50	123	48	19	48	10	200	71
141400025010	25 x 1" x 25	50	123	48	21	50	10	200	75
141400025013	25 x 1 1/4" x 25	73	173	62	25	67	5	70	—
141400032005	32 x 1/2" x 32	61	150	56	18	49	5	120	120
141400032007	32 x 3/4" x 32	61	150	56	19	52	5	120	118
141400032010	32 x 1" x 32	61	150	56	21	55	5	120	123
141400032013	32 x 1 1/4" x 32	73	173	62	25	67	5	70	270
141400032015	32 x 1 1/2" x 32	73	173	62	25	68	5	60	280
141400040010	40 x 1" x 40	73	173	62	21	63	—	70	188
141400040013	40 x 1 1/4" x 40	73	173	62	25	67	—	70	207
141400040015	40 x 1 1/2" x 40	73	173	62	25	68	—	60	204
141400040020	40 x 2" x 40	92	200	72	30	79	—	40	490
141400050015	50 x 1 1/2" x 50	92	200	72	25	73	—	40	323
141400050020	50 x 2" x 50	92	200	72	30	79	—	40	348
141400063020	63 x 2" x 63	106	239	82	30	86	—	20	522

90° Tee with Threaded Male Offtake

148400

Te de 90° Compresión Rosca Macho

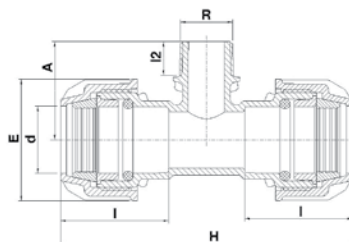

Product Code	Size d x R x d	E	H	I	I2	A	UB	UC	W
148400016005	16 x 1/2" x 16	42	113	44	17	44	10	300	33
148400016007	16 x 3/4" x 16	39	113	44	18	45	10	300	35
148400020005	20 x 1/2" x 20	42	113	44	17	44	10	300	44
148400020007	20 x 3/4" x 20	42	113	44	18	45	10	300	45
148400025005	25 x 1/2" x 25	50	124	48	17	45	10	220	63
148400025007	25 x 3/4" x 25	50	124	48	18	47	10	220	67
148400032007	32 x 3/4" x 32	61	150	56	18	49	5	120	112
148400032010	32 x 1" x 32	61	150	56	20	53	5	120	114
148400040010	40 x 1" x 40	73	173	62	20	65	—	70	182
148400040013	40 x 1 1/4" x 40	73	173	62	22	68	—	70	189
148400040015	40 x 1 1/2" x 40	73	173	62	22	69	—	70	192
148400050015	50 x 1 1/2" x 50	92	207	72	22	73	—	40	308
148400050020	50 x 2" x 50	92	207	72	26	77	—	40	316
148400063020	63 x 2" x 63	106	239	82	26	84	—	24	486

90° Reducing Tee with Irrifit Outlet

143400

Te de 90° Reductor

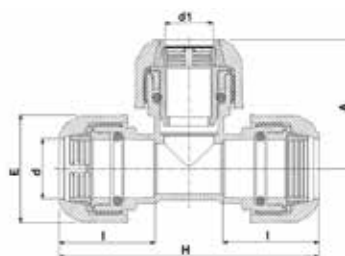

Product Code	Size d x d1 x d	E	H	I	A	UB	UC	W
143400020016	20 x 16 x 20	42	113	44	48	10	300	60
143400025016	25 x 16 x 25	50	124	48	50	10	200	70
143400032016	32 x 16 x 32	61	150	56	54	5	100	120
143400020020						10	180	70
143400025020	25 x 20 x 25	50	124	47	60	5	170	80
143400032020	32 x 20 x 32	61	150	56	75	5	100	170
143400032025	32 x 25 x 32	61	150	56	75	5	100	170
143400040025	40 x 25 x 40	73	173	62	86		60	290
143400040032	40 x 32 x 40	73	173	62	86		60	250
143400050025	50 x 25 x 50	92	207	74	104		32	500
143400050032	50 x 32 x 50	92	207	74	104		32	500
143400050040	50 x 40 x 50	92	207	74	104		32	500
143400063032	63 x 32 x 63	106	239	82	119		20	770
143400063040	63 x 40 x 63	106	239	82	119		20	770
143400063050	63 x 50 x 63	106	239	82	119		20	680

90° Elbow

140500

Codo de 90°

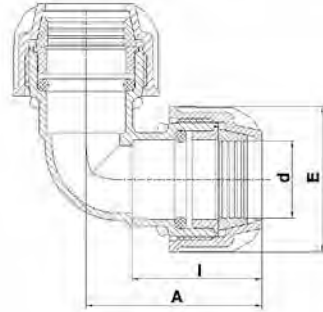

Product Code	Size d x d	E	I	A	UB	UC	W
140500016	16 x 16	39	51	64	10	350	50
140500020	20 x 20	42	43	57	10	440	38
140500025	25 x 25	50	47	62	10	250	59
140500032	32 x 32	61	56	75	10	150	102
140500040	40 x 40	73	62	86	—	90	164
140500050	50 x 50	92	74	104	—	50	276
140500063	63 x 63	106	82	119	—	32	442

90° Elbow with Threaded Female Offtake

141500

Codo de 90° Compresión Rosca Hembra

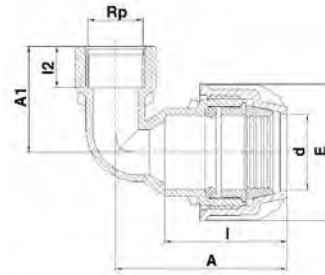

Product Code	Size d x Rp	E	I	I2	A	A1	UB	UC	W
141500016005	16 x 1/2"	39	50	19	66	39	10	500	39
141500020005	20 x 1/2"	42	44	17	56	42	10	600	29
141500020007	20 x 3/4"	42	44	18	56	42	10	500	30
141500025005	25 x 1/2"	50	48	18	68	45	10	380	44
141500025007	25 x 3/4"	50	48	18	68	45	10	380	43
141500025010	25 x 1"	50	48	21	68	50	10	340	48
141500032007	32 x 3/4"	61	56	18	75	47	10	220	64
141500032010	32 x 1"	61	56	21	75	60	10	200	70
141500032013	32 x 1 1/4"	61	56	25	75	66	10	160	91
141500040013	40 x 1 1/4"	73	62	25	86	70	—	120	130
141500040015	40 x 1 1/2"	73	62	25	86	70	—	110	141
141500040020	40 x 2"	92	72	30	102	79	70	1	300
141500050015	50 x 1 1/2"	92	74	25	102	79	—	70	203
141500050020	50 x 2"	92	74	30	102	79	—	70	226
141500063020	63 x 2"	106	82	30	115	86	—	44	327

90° Elbow with Threaded Male Offtake

148500

Codo de 90° Compresión Rosca Macho

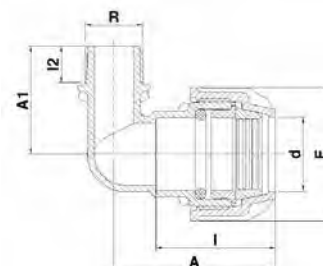

Product Code	Size d x R	E	I	I2	A	A1	UB	UC	W
148500016005	16 x 1/2"	39	58	17	70	44	10	600	28
148500016007	16 x 3/4"	39	58	18	70	45	10	600	28
148500020005	20 x 1/2"	42	43	17	57	44	10	600	26
148500020007	20 x 3/4"	42	43	18	57	45	10	600	29
148500025005	25 x 1/2"	50	47	17	62	45	10	400	36
148500025007	25 x 3/4"	50	47	18	62	47	10	400	39
148500025010	25 x 1"	50	47	19	62	49	10	400	39
148500032005	32 x 1/2"	61	56	17	75	49	10	240	65
148500032007	32 x 3/4"	61	56	18	75	49	10	240	62
148500032010	32 x 1"	61	56	20	75	53	10	240	66
148500040010	40 x 1"	73	62	20	86	65	—	120	103
148500040013	40 x 1 1/4"	73	62	22	86	68	—	120	114
148500040015	40 x 1 1/2"	73	62	22	86	69	—	120	121
148500050015	50 x 1 1/2"	92	74	22	104	73	—	70	176
148500050020	50 x 2"	92	74	26	104	77	—	70	192
148500063020	63 x 2"	106	82	26	119	84	—	48	248

Corner Elbow

146500

Codo de Esquina

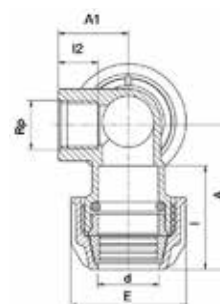

Product Code	Size d x Rp	E	I	I2	A	A1	UB	UC	W
146500020005	20 x 1/2"	42	39	17	58	30	10	350	50
146500025005	25 x 1/2"	50	44	17	62	30	10	250	70
146500025007	25 x 3/4"	50	44	17	62	30	10	250	60

Reducing Set

149300

Juego Reductor

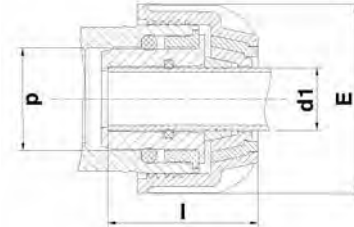
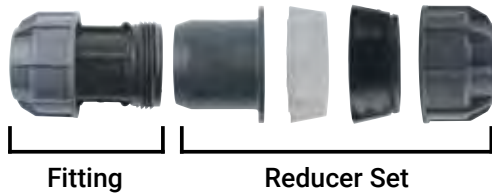

Product Code	Size d x d1	E	I	UB	UC	W
149300025020	25 x 20	50	42	10	450	28
149300032020	32 x 20	61	48	10	400	33
149300032025	32 x 25	61	46	10	360	29
149300040020	40 x 20	73	55	10	180	60
149300040025	40 x 32	73	55	10	180	70
149300040032	40 x 32	73	55	10	250	48
149300050025	50 x 25	92	59	5	200	83
149300050032	50 x 32	92	64	5	200	79
149300050040	50 x 40	92	62	5	200	75
149300063025	63 x 25	106	63	1	100	150
149300063032	63 x 32	106	68	1	100	144
149300063040	63 x 40	106	74	1	100	136
149300063050	63 x 50	106	72	1	100	128

Coupler Union Adaptor

1401M0

Enlace Recto Con Racor



Product Code	Size d x d1	UB	UC	W
1401M0032007	32 x 3/4"	5	100	9
1401M0032010	32 x 1"	5	100	12
1401M0040010	40 x 1"	—	60	13
1401M0040015	40 x 1 1/2"	—	60	14
1401M0050015	50 x 1 1/2"	—	40	24
1401M0050020	50 x 2"	—	40	23
1401M0063015	63 x 1 1/2"	—	25	38
1401M0063020	63 x 2"	—	25	49

Union Adaptor

1498M0

Adaptador A Rosca Macho

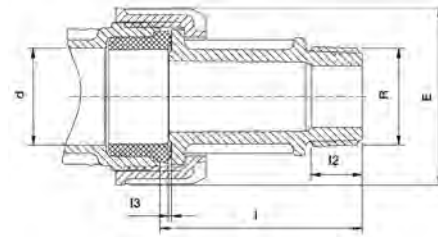

Product Code	Size d x R	E	I	I2	I3	UB	UC	W
1498M0032007	32 x 3/4"	61	68	18	1	1	180	77
1498M0032010	32 x 1"	61	69	20	1	1	180	55
1498M0040010	40 x 1"	73	70	20	1	1	130	142
1498M0040015	40 x 1 1/2"	73	71	22	1	1	130	89
1498M0050015	50 x 1 1/2"	92	73	24	1	1	80	126
1498M0050020	50 x 2"	92	79	27	1	1	80	133
1498M0063015	63 x 1 1/2"	106	75	22	1	1	60	—
1498M0063020	63 x 2"	106	77	26	1	1	60	306

Threaded Adaptor

142500

Adaptador Roscado

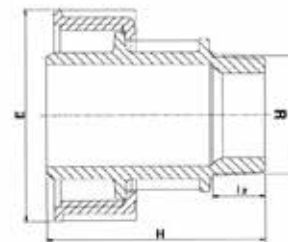

Product Code	Size d x R	E	H	I2	UB	UC	W
142500032005	32 x 1/2"	61	84	17	1	180	50
142500032007	32 x 3/4"	61	85	18	1	180	50
142500032010	32 x 1"	61	87	20	1	180	52
142500040010	40 x 1"	74	99	20	1	130	75
142500040013	40 x 1 1/4"	74	100	22	1	130	77
142500040015	40 x 1 1/2"	74	100	22	1	130	82
142500050010	50 x 1"	92	102	20	1	80	118
142500050013	50 x 1 1/4"	92	104	22	1	80	122
142500050015	50 x 1 1/2"	92	104	22	1	80	120
142500050020	50 x 2"	92	107	26	1	80	130
142500063010	63 x 1"	106	118	20	1	60	186
142500063013	63 x 1 1/4"	106	121	22	1	60	189
142500063015	63 x 1 1/2"	106	121	22	1	60	191
142500063020	63 x 2"	106	124	26	1	60	196
142500063025	63 x 2 1/2"	106	126	29	1	60	210

Threaded Male Adaptor

078901

Adaptador Compresión Rosca Macho

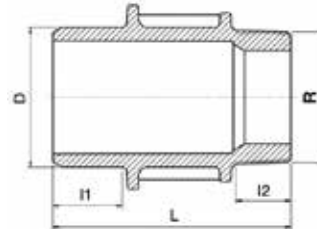

Product Code	Size d x R	L	I1	I2	UB	UC	W
078901025005P	25 x 1/2"	79	29	17	10	500	17
078901025007P	25 x 3/4"	80	29	18	10	500	20
078901032005P	32 x 1/2"	84	27	17	10	400	34
078901032007P	32 x 3/4"	85	27	18	10	400	35
078901032010P	32 x 1"	87	27	20	10	400	37
078901040010P	40 x 1"	99	33	20	—	220	54
078901040013P	40 x 1 1/4"	100	33	22	—	220	57
078901040015P	40 x 1 1/2"	100	33	22	—	220	61
078901050010P	50 x 1"	102	34	20	—	140	80
078901050013P	50 x 1 1/4"	104	34	22	—	140	40
078901050015P	50 x 1 1/2"	104	34	22	—	140	84
078901050020P	50 x 2"	107	34	26	—	140	91
078901063010P	63 x 1"	118	50	20	—	80	178
078901063013P	63 x 1 1/4"	121	50	22	—	80	140
078901063015P	63 x 1 1/2"	121	50	22	—	80	140
078901063020P	63 x 2"	124	50	26	—	80	146
078901063025P	63 x 2 1/2"	126	50	29	—	80	158

Nut for Threaded Adaptor

148940

Tuerca para Adaptador de Compresión



Product Code	Size d	UB	UC	W
148940032P	32	10	400	15
148940040P	40	—	200	20
148940050P	50	—	140	40
148940063P	63	5	120	70

Nut

140040

Racor



Product Code	Size d	UB	UC	W
140040016P	16	–	–	10
140040020P	20	10	1600	8
140040025P	25	10	1000	12
140040032P	32	10	500	21
140040040P	40	–	330	34
140040050P	50	–	180	68
140040063P	63	–	100	110

Split Ring - Polyacetal

140030

Casquillo de Apriete (acetal)



Product Code	Size d	UB	UC	W
070030016P	16	100	12000	1
140030020P	20	100	12000	2
140030025P	25	100	7000	3
140030032P	32	50	4200	4
140030040P	40	–	2000	8
140030050P	50	–	1200	12
140030063P	63	–	600	24

O-Ring

070020

Junta Tórica/Seil



Product Code	Size d	E1	e	UB	UC	W
070020016	16	15	3	100	30000	1
070020020	20	19	3	100	32000	1
070020025	25	24	4	100	12000	1
070020032	32	31	5	100	8000	2
070020040	40	39	6	50	4000	5
070020050	50	49	7	50	2500	8
070020063	63	62	7	50	2000	10

Insert

140050

Inserto de PP



Product Code	Size d	UB	UC	W
070050016P	16	100	8700	1
140050020P	20	100	10000	1
140050025P	25	—	5500	2
140050032P	32	50	3000	4
140050040P	40	—	2000	6
140050050P	50	—	1000	9
140050063P	63	—	500	15

Technical Specifications

Installation Instructions For Fittings

16mm - 63mm

- Cut the pipe square, chamfer the end of the pipe
- Undo the nut to the last thread. Leave the nut on the fitting while inserting the pipe.
- Twist the pipe into the fitting* through the split ring and rubber seal to the pipe stop. Tighten the nut firmly. Use a PLASSON wrench (or similar tool) for final tightening of sizes 40 and above.
- The nut should be closed tightly, however there is no need for the nut to actually meet the body shoulder.

* Lubrication and chamfering of the pipe end will ease insertion of the pipe (use silicone lubricant).

Note

Before installation ensure that the end of the pipe to be inserted into the fitting is free of scratches and other imperfections and that both the pipe and the fitting itself are clean of sand, mud, stones etc.

Do not over tighten nut when closing. Never use wrenches or spanners with handle lengths longer than 46 cm - excessive torque during tightening can spread nut cone and result in pull outs.

If fittings are reused, ensure split ring is sharp and bites into pipe to avoid pull outs. Alternatively replace split ring.

We strongly recommend the use of PTFE tape in threaded connections.

Legend

UB	Units par bag
UC	Units per carton
W	Weight in grams

Technical Specifications

PLASSON Silver Line - These fittings have been specially designed for joining polyethylene pipes used with a working pressure up to 10 bar. They are designed and approved according to ISO 17885 (replaced ISO 14236) and are available in sizes 16 - 63mm.

Features

- Perfectly watertight
- Extremely simple to use
- Easy and fast to reuse
- Designed with a captive O-ring
- Frost proof
- Suitable for outdoor use in direct sunlight
- Highly impact resistant

Materials

Body: Polypropylene, high-grade copolymer

Nut: Polypropylene, high-grade copolymer

Split Ring: Polyacetal (POM)

Seal: Nitrile rubber (EPDM)

Operating Temperatures

The fittings are not to be used with hot water, although they withstand the same temperature as the polyethylene pipe itself. The fittings and valves will withstand sub-zero temperatures.

Threads

Threads marked "R", "Rp" and "Rc" are according to ISO 7-1. Threads marked "G" are according to ISO 228.

Especificaciones Técnicas

Installation Instructions Para accesorios de 16mm - 63mm

- Corte el tubo al tamaño requerido y realice el biselado al final del tubo
 - Retire el racor hasta su última rosca dejándolo en el accesorio durante el próximo paso.
 - Introduzca el tubo con un movimiento circular dentro del accesorio pasando el casquillo de apriete y el sello hasta llegar al tope interno del accesorio
 - Gire firmemente el racor en dirección del cuerpo del accesorio, utilizando la llave PLASSON (o similar) en los tamaños 40mm y mayores.
 - Cierre el racor firmemente, aunque no es necesario cerrarlo hasta el tope.
- * A fin de facilitar la introducción es conveniente lubricar y biselar el tubo (con un lubricante que conforma las normas de aprobación de calidad del agua).

Nota

Antes de la instalación asegure que:
El extremo del tubo introducido no tenga imperfecciones o rayaduras. Tanto el tubo como el accesorio no tenga sobre los mismos arena, barro o piedras, etc. No cierre el racor con extremada fuerza, nunca use llaves con manijas más largas de 46 cm.

Un excesivo momento de torsión durante el cierre puede dañar el cono del racor y como resultado del mismo no permitir su propio funcionamiento. Si los accesorios son usados nuevamente después de su desarmado, constate que los dientes del casquillo de apriete permanecen afilados y se hincan en el tubo impidiendo el escape del tubo. Si no es así, cambie el casquillo de apriete.

Recomendamos utilizar cinta de PTFE para sellar todas las conexiones roscadas.

Legend

UB	Unidades por bolsa
UC	Unidades por cartón
W	Peso en gramos

Especificaciones Técnicas

Los accesorios de la Línea Silver de **PLASSON** han sido diseñados para la unión de tuberías de polietileno de alta densidad usados con una presión de trabajo de hasta 10 bar. Están diseñados de acuerdo a las normas ISO y están disponibles en diámetros de 16 - 63mm.

Características

- Estanqueidad completa
- Fácil instalación
- Rápida reutilización
- Diseñada con una junta tórica cautiva
- Resistencia a bajas temperaturas
- Frost Proof
- Resistentes para instalación a la intemperie
- Alta resistencia a golpes o impactos

Materiales

Cuerpo: Polipropileno, block copolímero de alta calidad

Racor: Polipropileno, block copolímero de alta calidad

Casquillo de apriete: Polyacetal (POM)

Junta tórica: Nitrilo (EPDM)

Temperaturas de Trabajo

Los accesorios no son recomendados para usar con agua caliente, aunque soportan las mismas temperaturas que las propias tuberías de polietileno.
Sin embargo pueden resistir temperaturas inferiores a los cero grados centígrados.

Roscas

Roscas marcadas "R", "Rp" y "Rc" de conformidad con la normativa ISO 7-1.

Roscas "G" de conformidad con la normativa ISO 228.

